

# Dombrecht

DISTRIBUTION

Front office

[Info@dombrecht.eu](mailto:Info@dombrecht.eu)

Tel.052/44.74.84

Fax. 052/44.90.52

Ma-Vri: 09u00- 12u30 13u - 16u00

---

Webshop 24/7

[www.dombrecht.eu](http://www.dombrecht.eu)

---

Sales

Xavier.lebailly@dombrecht.eu

0499/16.36.37

Jeroen.pieraerts@dombrecht.eu

0493/51.48.13

---

Magazijn

Ma - Vr: 08u30 - 12u30 13u00 - 17u00

Schrijnwerkerstraat 1 9240 Zele

---

Sluitplannen

MKSYS@dombrecht.eu

Tel. 052/44.74.84

---

Boekhouding

Finance@dombrecht.eu

Tel. 052/44.74.84

---



<b>Cilinders &amp; hangsloten</b>	<b>1</b>
<b>Enkelpunt sloten</b>	<b>2</b>
<b>Meerpuntsloten</b>	<b>3</b>
<b>Elektrische sloten</b>	<b>4</b>
<b>Elektrische deuropeners</b>	<b>5</b>
<b>Beslag en Rozetten</b>	<b>6</b>
<b>Deurdrangers</b>	<b>7</b>
<b>Opbouwsloten</b>	<b>8</b>
<b>Anti-Panieksluitingen</b>	<b>9</b>
<b>Deurmagneten</b>	<b>10</b>
<b>Sleutelkluisjes</b>	<b>11</b>

# Definitie van Deurgebruik

Algemene Instructies

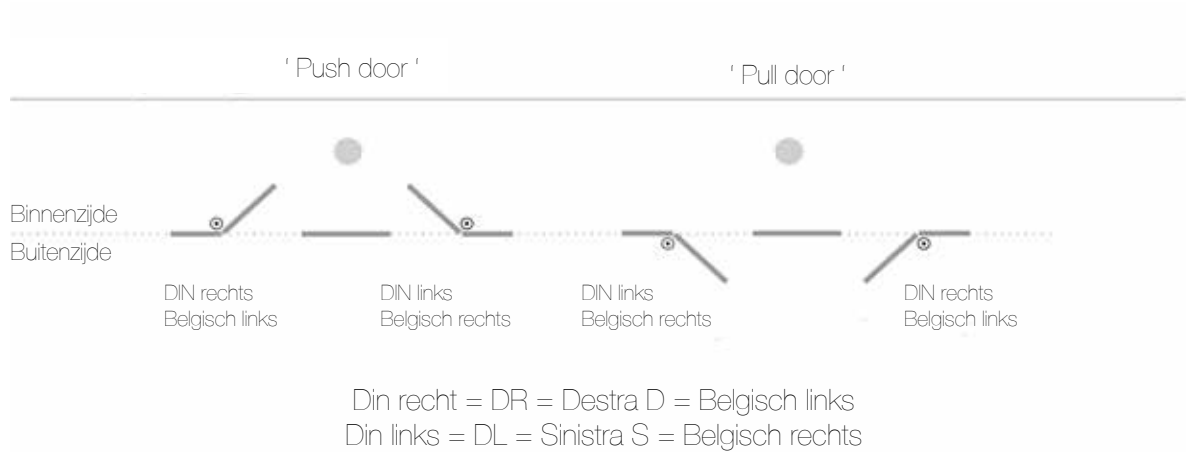

## Algemene instructies

Om de cilinder in te oliën, gebruikt u enkel een goede slotspray



Zorg er voor dat vijlsel van boringen of vullingen niet in het slot terechtkomen

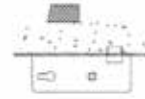

Schilder nooit over de sluitplaat, dit kan schade aanbrengen aan nacht- en dagschoot



Schroeven mogen niet leiden tot schade aan het product

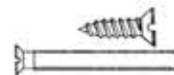

Volg zorgvuldig de handleiding bij het installeren of roep de hulp in van vakmensen

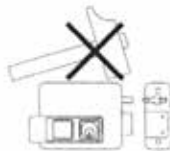

Gelieve bij het installeren van het slot enkel gebruik te maken van de aanbevolen transformators in de handleiding



your world safely locked //®

# Iseo Cilinders & hangsloten



your world safely locked //®

Versie v1.1.2



# Cilinder overzicht



F3 F5 F6 R6 F9 F9000 R9plus R50

5 stiften								
6 stiften								
Extra stiften								
actieve en passieve stift								
Dubbele cilinder								
Gevarenfunctie (DUO/GF)								
vrijloop ( VRIJ)								
knopcilinder (KN)								
halve met verstelbare meenemer								
schroefcilinder								
schroefcilinder elektrisch contact								
oplegcilinder								
nummering op de sleutel								
Getand								
Keersleutel								
eigen profiel mogelijk								
gelijksluitend (KA)								
sluitplannen (MK)								
Merk patent								
eigendomskaart								
Modulaire								
Boorbeveiliging: Body								
Rotor								
Breekbeveiliging								



**Werfcilinders**  
 Cilinders zonder patent  
**Standaardcilinders**  
 Cilinders zonder patent

**Zekerheidscilinders**  
 cilinder zonder patent

**Veiligheidscilinder**  
 Gepatenteerde Cilinder

**Hangsloten**  
 Hangsloten

**Elektronische Cilinder**

**Onderdelen**

**Sluitplannen**

11

21

39

61

67

73

112

- 11. Iseo F3  
Werfcilinder - Tandgesneden
- 13. Iseo F5  
Budgetcilinder - Tandgesneden
- 20. Iseo F5  
Oplegcilinder - Tandgesneden
- 22. Iseo F6  
Zekerheidscilinder - Tandgesneden
- 31. Iseo R6  
Zekerheidscilinder Puntgeboord
- 38. Iseo R6  
Oplegcilinder Puntgeboord
- 39. Iseo F9  
Patentcilinder tandgesneden
- 46. Iseo F9  
Oplegcilinder tandgesneden
- 47. Iseo R9 Plus  
Veiligheidscilinder Puntgeboord
- 52. Iseo R9 Plus  
Oplegcilinder Puntgeboord
- 53. Iseo R50  
patentcilinder Puntgeboord

- 61. Iseo Hangslot  
Normale beugel
- 62. Iseo Hangslot  
Verlengde beugel
- 63. Iseo Marine hangslot  
weersbestendige uitvoering
- 64. Iseo Boxer - Universal  
Veiligheidshangslot
- 65. Iseo Cavers  
Hangslot met code
- 68. Iseo Libra Smart  
Elektronische knopcilinder
- 71. Iseo F9000  
Elektromechanische cilinder
- 73. Iseo bestiftingsonderdelen  
Stiften, tangen, montage apparaat, ...
- 106. LE60  
Modulaire onderdelen
- 112. Sluitplannen



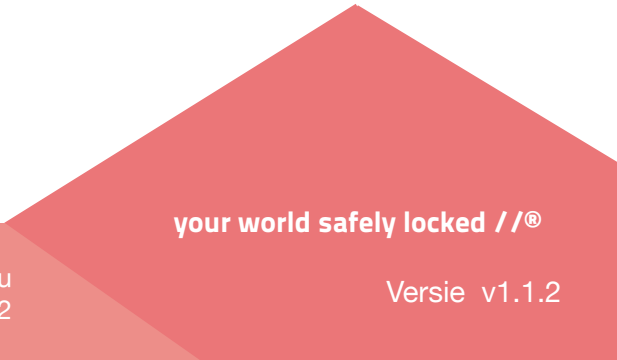

your world safely locked //®



**Dombrecht**  
DISTRIBUTION

Info@dombrecht.eu www.dombrecht.eu  
Tel: 052/44 74 84 Fax: 052/44 90 52

Versie v1.1.2

# Iseo F3

Werfcilinder

## Sleutel

- Tandgesneden
- Messing vernikkeld

## Cilinder

- 5 codestiften
- Messing stiften
- Geen mogelijkheid tot KA
- Geen nabestelling op code

Ideale cilinder voor tijdelijke toepassingen of depannage



**F3 Euro profiel cilinder**

- 5 messingstiften
- 30° DIN cam
- 3 sleutels
- M5 bevestigingsschroef



30	10	F20930103N
----	----	------------

30	F20930303N
----	------------

35	F20930353N
----	------------

40	F20930403N
----	------------

45	F20930453N
----	------------

50	F20930503N
----	------------

60	F20930603N
----	------------

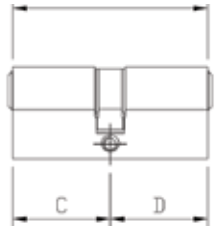

35	10	F20935103N
----	----	------------

35	F20935353N
----	------------

40	F20935403N
----	------------

45	F20935453N
----	------------

40	40	F20940403N
----	----	------------

45	F20940453N
----	------------

50	F20940503N
----	------------

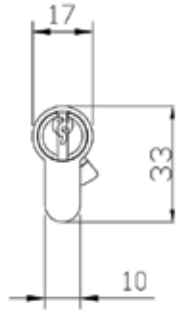

# Iseo F5

Standaardcilinder

## Sleutel

- Tandgesneden
- Vernikkelde sleutel
- Genummerd
- 3 sleutels per cilinder

## Cilinder

- 5 codestiften
- Kernstiften in messing
- 4 Messing tegenstiften (Anti-picking)

## Mogelijkheden

- Verschillend sluitende cilinders (KD)
- Gelijksluitende cilinders (KA)
- Gevarenfunctie (GF)
- Sluitplannen (MK)
- Knopcilinder (KN)
- Oplegcilinder
- Halve cilinder met verstelbare meenemer
- Italiaanse meenemer
- Vrijloopcilinder (VRIJ)
- Tandwielcilinder: 10, 13 of 14 tanden
- 21-21 = 3 stiften
- 25-25 & 25-30 = 4 stiften
- 25-10 : geen verstelbare meenemer
- Gelijksluitend ( KA) kan ook affabriek besteld worden. Goedkoper, maar langere levertermijn.

## Pluspunten

- Prijs/Kwaliteit
- Licht vooruitstaande rotor voor een betere sleutelgeleiding





**F5 Euro profiel cilinder**  
 5 messingstiften met 4 tegenstiften (Anti-picking)  
 30° DIN cam  
 3 genummerde sleutels  
 M5 bevestigingsschroef

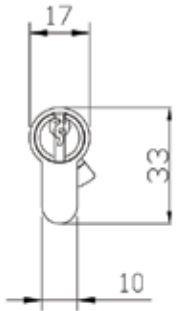
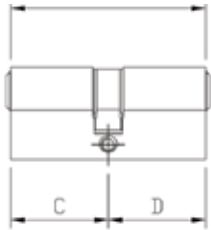

25	25I 820925259	40	10I 820940109
	30I 820925309		40I 820940409
28	28I 820928289		45I 820940459
	33I 820928339		50I 820940509
30	10I 820930109		55I 820940559
	30I 820930309		60I 820940609
	35I 820930359		70I 820940709
	40I 820930409	45	10I 820945109
	45I 820930459		45I 820945459
	50I 820930509		50I 820945509
	55I 820930559		55I 820945559
	60I 820930609		60I 820945609
	65I 820930659	50	10I 820950109
	70I 820930709		50I 820950509
	75I 820930759		55I 820950559
	80I 820930809		60I 820950609
	90I 820930909	55	10I 820955109
35	10I 820935109	60	10I 820960109
	35I 820935359	65	10I 820965109
	40I 820935409	70	10I 820970109
	45I 820935459	80	10I 820980109
	50I 820935509	90	10I 820990109
	55I 820935559	95	10I 820995109
	60I 820935609		
	65I 820935659		
	70I 820935709		
	75I 820935759		
	80I 820935809		
	85I 820935859		

**F5 Euro profiel Knopcilinder (KN)**  
 5 messingstiften met 4 tegenstiften (Anti-picking)  
 30° DIN cam  
 3 genummerde sleutels  
 M5 bevestigingsschroef



28	28I 825928289	45	10I 825945109
30	10I 825930109		30I 825945309
	30I 825930309		35I 825945359
	35I 825930359		40I 825945409
	40I 825930409		45I 825945459
	45I 825930459		50I 825945509
	50I 825930509		55I 825945559
	55I 825930559	60I 825945609	
	60I 825930609	50	10I 825950109
	65I 825930659		30I 825950309
	70I 825930709		35I 825950359
	80I 825930809		40I 825950409
35	10I 825935109		45I 825950459
	30I 825935309		50I 825950509
	35I 825935359		55I 825950559
	40I 825935409		60I 825950609
	45I 825935459	55	10I 825955109
	50I 825935509		30I 825955309
	55I 825935559		35I 825955359
	60I 825935609		40I 825955409
	65I 825935659		45I 825955459
	75I 825935759	60	10I 825960109
40	10I 825940109		30I 825960309
	30I 825940309		35I 825960359
	35I 825940359		40I 825960409
	40I 825940409		45I 825960459
	45I 825940459	65	10I 825965109
	50I 825940509		30I 825965309
	55I 825940559		35I 825965359
	60I 825940609	70	10I 825970109
			30I 825970309
			35I 825970359
		80	30I 825980309





## F5 Euro profiel cilinder met gevarenfunctie (GF)

5 messingstiften met 4 tegenstiften (Anti-picking)

30° DIN cam

3 genummerde sleutels

M5 bevestigingsschroef



30 30I 829930309

35I 829930359

40I 829930409

45I 829930459

50I 829930509

55I 829930559

60I 829930609

65I 829930659

70I 829930709

75I 829930759

80I 829930809

35 35I 829935359

40I 829935409

45I 829935459

50I 829935509

55I 829935559

60I 829935609

65I 829935659

70I 829935709

75I 829935759

80I 829935809

40 40I 829940409

45I 829940459

50I 829940509

55I 829940559

60I 829940609

45 45I 829945459

50I 829945509

55I 829945559

60I 829945609

50 50I 829950509

60I 829950609

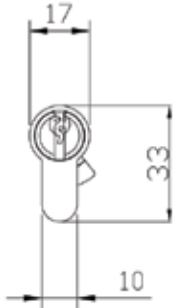
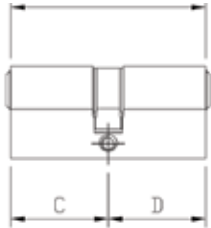

**F5 Euro profiel cilinder Gelijksluitend (KA)**  
 5 messingstiften met 4 tegenstiften (Anti-picking)  
 30° DIN cam  
 3 genummerde sleutels  
 M5 bevestigingsschroef

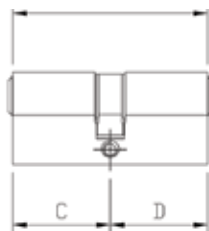

25	25  820925259.4DD	40	10  820940109.5DD
25	30  820925309.4DD		40  820940409.5DD
28	28  820928289.5DD		45  820940459.5DD
	33  820928339.5DD		50  820940509.5DD
30	10  820930109.5DD		55  820940559.5DD
	30  820930309.5DD		60  820940609.5DD
	35  820930359.5DD		70  820940709.5DD
	40  820930409.5DD	45	10  820945109.5DD
	45  820930459.5DD		45  820945459.5DD
	50  820930509.5DD		50  820945509.5DD
	55  820930559.5DD		55  820945559.5DD
	60  820930609.5DD		60  820945609.5DD
	65  820930659.5DD	50	10  820950109.5DD
	70  820930709.5DD		50  820950509.5DD
	75  820930759.5DD		55  820950559.5DD
	80  820930809.5DD		60  820950609.5DD
	90  820930909.5DD	55	10  820955109.5DD
35	10  820935109.5DD		30  825955309.5DD
	35  820935359.5DD	60	10  820960109.5DD
	40  820935409.5DD	65	10  820965109.5DD
	45  820935459.5DD	70	10  820970109.5DD
	50  820935509.5DD	80	10  820980109.5DD
	55  820935559.5DD	90	10  820990109.5DD
	60  820935609.5DD	95	10  820995109.5DD
	65  820935659.5DD		
	70  820935709.5DD		
	75  820935759.5DD		
	80  820935809.5DD		
	85  820935859.5DD		



## F5 Euro profiel knopcilinder (KN) gelijksluitend (KA)

5 messingstiften met 4 tegenstiften (Anti-picking)

30° DIN cam

3 genummerde sleutels

M5 bevestigingsschroef

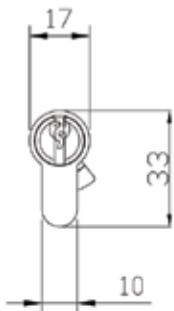
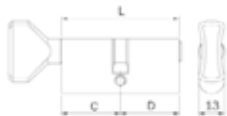

28	28I 825928289.5DD	45	30I 825945309.5DD
30	30I 825930309.5DD		35I 825945359.5DD
	35I 825930359.5DD		40I 825945409.5DD
	40I 825930409.5DD		45I 825945459.5DD
	45I 825930459.5DD		50I 825945509.5DD
	50I 825930509.5DD		55I 825945559.5DD
	55I 825930559.5DD		60I 825945609.5DD
	60I 825930609.5DD	50	30I 825950309.5DD
	65I 825930659.5DD		35I 825950359.5DD
	70I 825930709.5DD		40I 825950409.5DD
	75I 825930759.5DD		45I 825950459.5DD
	80I 825930809.5DD		50I 825950509.5DD
35	30I 825935309.5DD		55I 825950559.5DD
	35I 825935359.5DD		60I 825950609.5DD
	40I 825935409.5DD	55	35I 825955359.5DD
	45I 825935459.5DD	60	30I 825960309.5DD
	50I 825935509.5DD		35I 825960359.5DD
	55I 825935559.5DD		45I 825960459.5DD
	60I 825935609.5DD		50I 825960509.5DD
	65I 825935659.5DD	65	30I 825965309.5DD
	75I 825935759.5DD		35I 825965359.5DD
40	30I 825940309.5DD	70	30I 825970309.5DD
	35I 825940359.5DD		35I 825970359.5DD
	40I 825940409.5DD	80	30I 825980309.5DD
	45I 825940459.5DD		
	50I 825940509.5DD		
	55I 825940559.5DD		
	60I 825940609.5DD		

**F5 Euro profiel cilinder gelijksluitend (KA) met gevarenfunctie (GF)**

5 messingstiften met 4 tegenstiften (Anti-picking)

30° DIN cam

3 genummerde sleutels

M5 bevestigingsschroef

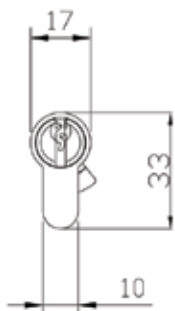
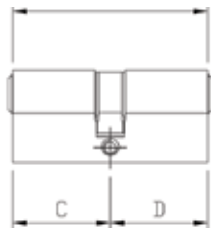

30	30I 829930309.5DD
	35I 829930359.5DD
	40I 829930409.5DD
	45I 829930459.5DD
	50I 829930509.5DD
	55I 829930559.5DD
	60I 829930609.5DD
	65I 829930659.5DD
	70I 829930709.5DD
	75I 829930759.5DD
	80I 829930809.5DD
35	35I 829935359.5DD
	40I 829935409.5DD
	45I 829935459.5DD
	50I 829935509.5DD
	55I 829935559.5DD
	60I 829935609.5DD
	65I 829935659.5DD
	70I 829935709.5DD
	75I 829935759.5DD
40	40I 829940409.5DD
	45I 829940459.5DD
	50I 829940509.5DD
	55I 829940559.5DD
	60I 829940609.5DD
45	45I 829945459.5DD
	50I 829945509.5DD
	55I 829945559.5DD
	60I 829945609.5DD
50	50I 829950509.5DD
	60I 829950609.5DD

**F5 Oplegcilinder**

5 messingstiften

3 genummerde sleutels

Voor een maximale deurdikte van 85mm



I 850007 F5 OPLEGCILINDER KOPER

I 850035009 F5 OPLEGCILINDER MAT



# Iseo F6

Standaardcilinder

## Sleutel

- Tandgesneden
- Messing vernikkeld
- Genummerd
- 3 sleutels per cilinder

## Cilinder

- 6 codestiften in inox
- 4 messing tegenstiften (Anti-picking)
- Hardstaal stiften
- Antiboor stift in de body

## Mogelijkheden

- Verschillend sluitende cilinders (KD)
- Gelijksluitende cilinders (KA)
- Gevarenfunctie (GF)
- Sluitplannen (MK)
- Knopcilinder (KN)
- Oplegcilinder
- Halve cilinder met verstelbare meenemer
- Italiaanse meenemer
- Vrijloopcilinder (VRIJ)
- Tandwielcilinder: 10, 13 of 14 tanden

## Pluspunten

- Prijs/Kwaliteit/Veiligheid





**F6 Euro profiel cilinder**  
 6 Hardstaalstiften met 4 tegenstiften (Anti-picking)  
 30° DIN cam  
 3 genummerde sleutels  
 M5 bevestigingsschroef  
 Boorbescherming in de body

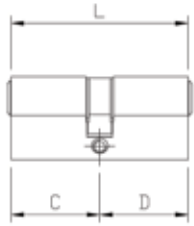

28	28I 810928289	40	10I 810940109
	33I 810928339		40I 810940409
30	10I 810930109		45I 810940459
	30I 810930309		50I 810940509
	35I 810930359		55I 810940559
	40I 810930409		60I 810940609
	45I 810930459		65I 810940659
	50I 810930509		70I 810940709
	55I 810930559		75I 810940759
	60I 810930609		80I 810940809
	65I 810930659		85I 810940859
	70I 810930709		90I 810940909
	75I 810930759	45	10I 810945109
	80I 810930809		45I 810945459
	85I 810930859		50I 810945509
	90I 810930909		55I 810945559
35	10I 810935109		60I 810945609
	35I 810935359		65I 810945659
	40I 810935409		70I 810945709
	45I 810935459		75I 810945759
	50I 810935509		80I 810945809
	55I 810935559		85I 810945859
	60I 810935609	50	10I 810950109
	65I 810935659		50I 810950509
	70I 810935709		55I 810950559
	75I 810935759		60I 810950609
	80I 810935809		65I 810950659
	85I 810935859		70I 810950709
	90I 810935909		75I 810950759
			80I 810950809

**F6 Euro profiel cilinder**

6 Hardstaalfstiften met 4 tegenstiften (Anti-picking)

30° DIN cam

3 genummerde sleutels

M5 bevestigingsschroef

Boorbescherming in de body

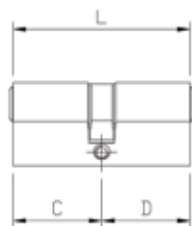

55 10I 810955109

55I 810955559

60I 810955609

65I 810955659

70I 810955709

75I 810955759

60 10I 810960109

60I 810960609

65I 810960659

70I 810960709

65 10I 810965109

70 10I 810970109

75 10I 810975109

80 10I 810980109

85 10I 810985109

90 10I 810990109



## F6 Euro profiel Knopcilinder (KN)

6 Hardstaalfstiften met 4 tegenstiften (Anti-picking)  
 30° DIN cam  
 3 genummerde sleutels  
 M5 bevestigingsschroef  
 Boorbescherming in de body



30	30I 818930309	45	45I 818945459
	35I 818930359		50I 818945509
	40I 818930409		55I 818945559
	45I 818930459		60I 818945609
	50I 818930509		65I 818945659
	55I 818930559		70I 818945709
	60I 818930609	50	50I 818950509
	65I 818930659		60I 818950609
35	35I 818935359		65I 818950659
	40I 818935409	55	55I 818955559
	45I 818935459		60I 818955609
	50I 818935509	60	60I 818960609
	55I 818935559		65I 818960659
	60I 818935609		
	65I 818935659		
40	40I 818940409		
	45I 818940459		
	50I 818940509		
	55I 818940559		
	60I 818940609		
	65I 818940659		

**F6 Euro profiel cilinder met gevarenfunctie (GF)**

6 Hardstaalstiften met 4 tegenstiften (Anti-picking)

30° DIN cam

3 genummerde sleutels

M5 bevestigingsschroef

Boorbescherming in de body

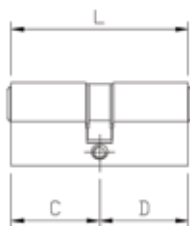

30	30   819930309	65   819940659
	35   819930359	70   819940709
	40   819930409	75   819940759
	45   819930459	80   819940809
	50   819930509	85   819940859
	55   819930559	90   819940909
	60   819930609	45   45   819945459
	65   819930659	50   819945509
	70   819930709	55   819945559
	75   819930759	60   819945609
	80   819930809	65   819945659
	85   819930859	70   819945709
	90   819930909	75   819945759
35	35   819935359	80   819945809
	40   819935409	85   819945859
	45   819935459	50   50   819950509
	50   819935509	55   819950559
	55   819935559	60   819950609
	60   819935609	65   819950659
	65   819935659	70   819950709
	70   819935709	75   819950759
	75   819935759	80   819950809
	80   819935809	55   55   819955559
	85   819935859	60   819955609
	90   819935909	65   819955659
40	40   819940409	70   819955709
	45   819940459	75   819955759
	50   819940509	60   60   819960609
	55   819940559	65   819960659
	60   819940609	70   819960709



**F6 Euro profiel cilinder gelijksluitend (KA)**  
 6 Hardstaalstiften met 4 tegenstiften (Anti-picking)  
 30° DIN cam  
 3 genummerde sleutels  
 M5 bevestigingsschroef  
 Boorbescherming in de body

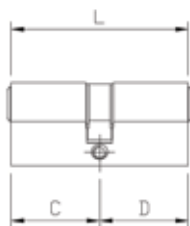

28	28I 810928289.5DD	40I 810940409.5DD	
	33I 810928339.5DD	45I 810940459.5DD	
30	10I 810930109.5DD	50I 810940509.5DD	
	30I 810930309.5DD	55I 810940559.5DD	
	35I 810930359.5DD	60I 810940609.5DD	
	40I 810930409.5DD	65I 810940659.5DD	
	45I 810930459.5DD	70I 810940709.5DD	
	50I 810930509.5DD	75I 810940759.5DD	
	55I 810930559.5DD	80I 810940809.5DD	
	60I 810930609.5DD	85I 810940859.5DD	
	65I 810930659.5DD	90I 810940909.5DD	
	70I 810930709.5DD	45	10I 810945109.5DD
	75I 810930759.5DD		45I 810945459.5DD
	80I 810930809.5DD		50I 810945509.5DD
	85I 810930859.5DD		55I 810945559.5DD
	90I 810930909.5DD		60I 810945609.5DD
35	10I 810935109.5DD		65I 810945659.5DD
	35I 810935359.5DD		70I 810945709.5DD
	40I 810935409.5DD		75I 810945759.5DD
	45I 810935459.5DD		80I 810945809.5DD
	50I 810935509.5DD		85I 810945859.5DD
	55I 810935559.5DD	50	10I 810950109.5DD
	60I 810935609.5DD		50I 810950509.5DD
	65I 810935659.5DD		55I 810950559.5DD
	70I 810935709.5DD		60I 810950609.5DD
	75I 810935759.5DD		65I 810950659.5DD
	80I 810935809.5DD		70I 810950709.5DD
	85I 810935859.5DD		75I 810950759.5DD
	90I 810935909.5DD		80I 810950809.5DD
40	10I 810940109.5DD		

**F6 Euro profiel cilinder gelijksluitend (KA)**

6 Hardstaaltiften met 4 tegenstiften (Anti-picking)

30° DIN cam

3 genummerde sleutels

M5 bevestigingsschroef

Boorbescherming in de body

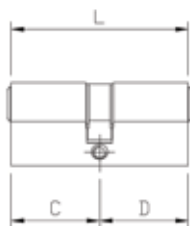

55	10I 810955109.5DD
	55I 810955559.5DD
	60I 810955609.5DD
	65I 810955659.5DD
	70I 810955709.5DD
	75I 810955759.5DD
60	10I 810960109.5DD
	60I 810960609.5DD
	65I 810960659.5DD
	70I 810960709.5DD
65	10I 810965109.5DD
	70I 810970109.5DD
	75I 810975109.5DD
	80I 810980109.5DD
	85I 810985109.5DD
	90I 810990109.5DD

## F6 Euro profiel knopcilinder (KN) gelijksluitend (KA)

6 Hardstaalfstiften met 4 tegenstiften (Anti-picking)

30° DIN cam

3 genummerde sleutels

M5 bevestigingsschroef

Boorbescherming in de body



30 30I 818930309.5DD

35I 818930359.5DD

40I 818930409.5DD

45I 818930459.5DD

50I 818930509.5DD

55I 818930559.5DD

60I 818930609.5DD

65I 818930659.5DD

35 35I 818935359.5DD

40I 818935409.5DD

45I 818935459.5DD

50I 818935509.5DD

55I 818935559.5DD

60I 818935609.5DD

65I 818935659.5DD

40 40I 818940409.5DD

45I 818940459.5DD

50I 818940509.5DD

55I 818940559.5DD

60I 818940609.5DD

65I 818940659.5DD

45 45I 818945459.5DD

50I 818945509.5DD

55I 818945559.5DD

60I 818945609.5DD

65I 818945659.5DD

70I 818945709.5DD

50 50I 818950509.5DD

60I 818950609.5DD

65I 818950659.5DD

55 55I 818955559.5DD

60I 818955609.5DD

60 60I 818960609.5DD

65I 818960659.5DD

**F6 Euro profiel cilinder gelijksluitend (KA) met gevarenfunctie (GF)**

6 Hardstaalfstiften met 4 tegenstiften (Anti-picking)

30° DIN cam

3 genummerde sleutels

M5 bevestigingsschroef

Boorbescherming in de body

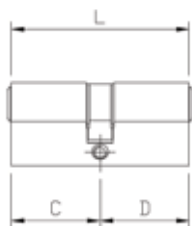

30	30I 819930309.5DD	65I 819940659.5DD
	35I 819930359.5DD	70I 819940709.5DD
	40I 819930409.5DD	75I 819940759.5DD
	45I 819930459.5DD	80I 819940809.5DD
	50I 819930509.5DD	85I 819940859.5DD
	55I 819930559.5DD	90I 819940909.5DD
	60I 819930609.5DD	45
	65I 819930659.5DD	45I 819945459.5DD
	70I 819930709.5DD	50I 819945509.5DD
	75I 819930759.5DD	55I 819945559.5DD
	80I 819930809.5DD	60I 819945609.5DD
	85I 819930859.5DD	65I 819945659.5DD
	90I 819930909.5DD	70I 819945709.5DD
35	35I 819935359.5DD	75I 819945759.5DD
	40I 819935409.5DD	80I 819945809.5DD
	45I 819935459.5DD	85I 819945859.5DD
	50I 819935509.5DD	50
	55I 819935559.5DD	50I 819950509.5DD
	60I 819935609.5DD	55I 819950559.5DD
	65I 819935659.5DD	60I 819950609.5DD
	70I 819935709.5DD	65I 819950659.5DD
	75I 819935759.5DD	70I 819950709.5DD
	80I 819935809.5DD	75I 819950759.5DD
	85I 819935859.5DD	80I 819950809.5DD
	90I 819935909.5DD	55
40	40I 819940409.5DD	55I 819955559.5DD
	45I 819940459.5DD	60I 819955609.5DD
	50I 819940509.5DD	65I 819955659.5DD
	55I 819940559.5DD	70I 819955709.5DD
	60I 819940609.5DD	75I 819955759.5DD
		60
		60I 819960609.5DD
		65I 819960659.5DD
		70I 819960709.5DD





your world safely locked //®



**Dombrecht**  
DISTRIBUTION

Info@dombrecht.eu www.dombrecht.eu  
Tel: 052/44 74 84 Fax: 052/44 90 52

Versie v1.1.2

# Iseo R6

Zekerheids Cilinder

## Sleutel

- Keersleutel
- Messing vernikkeld
- Genummerd
- 3mm dikke sleutel

## Cilinder

- 6 codestiften in inox
- 4 messing tegenstiften ( Anti-picking)
- Anti-picking met actieve stiften
- Afbreekbescherming in U-vorm
- Boorbescherming in body en rotor
- Niet gepatenteerde sleutel

## Mogelijkheden

- Verschillend sluitende cilinders (KD)
- Gelijksluitende cilinders ( KA)
- Gevarenfunctie ( GF)
- Sluitplannen (MK)
- Knopcilinder (KN)
- Oplegcilinder
- Italiaanse meenemer
- Vrijloopcilinder (VRIJ)
- Tandwielcilinder: 10, 13 of 14 tanden

## Pluspunten

- Prijs/Kwaliteit
- Lange sleutelhals
- SKG\*\* 
- Uittrekbeveiliging tot 7N



your world safely locked //®



## R6 Euro profiel cilinder

6 messingstiften  
 Anti-picking met actieve stiften  
 30° DIN cam  
 3 genummerde sleutels  
 M5 bevestigingsschroef  
 Afbreekbescherming in U-vorm  
 Boorbescherming in de body  
 SKG\*\* 

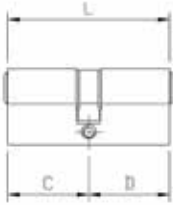

30	10I 8B0930109	45	10I 8B0945109
	30I 8B0930309		45I 8B0945459
	35I 8B0930359		50I 8B0945509
	40I 8B0930409		55I 8B0945559
	45I 8B0930459		60I 8B0945609
	50I 8B0930509	50	10I 8B0950109
	55I 8B0930559		50I 8B0950509
	60I 8B0930609		55I 8B0950559
	65I 8B0930659		60I 8B0950609
	70I 8B0930709	55	10I 8B0955109
	75I 8B0930759	60	10I 8B0960109
	80I 8B0930809	65	10I 8B0965109
35	10I 8B0935109	70	10I 8B0970109
	35I 8B0935359	80	10I 8B0980109
	40I 8B0935409	90	10I 8B0990109
	45I 8B0935459		
	50I 8B0935509		
	55I 8B0935559		
	60I 8B0935609		
	65I 8B0935659		
40	10I 8B0940109		
	40I 8B0940409		
	45I 8B0940459		
	50I 8B0940509		
	55I 8B0940559		
	60I 8B0940609		
	65I 8B0940659		
	70I 8B0940709		



### R6 Euro profiel Knopcilinder (KN)

- 6 messingstiften
- Anti-picking met actieve stiften
- 30° DIN cam
- 3 genummerde sleutels
- M5 bevestigingsschroef
- Afbreekbescherming in U-vorm
- Boorbescherming in de body
- SKG\*\*



30	10I 8B5930109	45	10I 8B5945109
	30I 8B5930309		30I 8B5945309
	35I 8B5930359		35I 8B5945359
	40I 8B5930409		40I 8B5945409
	45I 8B5930459		45I 8B5945459
	50I 8B5930509		55I 8B5945559
	55I 8B5930559		50I 8B5945509
	60I 8B5930609		60I 8B5945609
	65I 8B5930659	50	10I 8B5950109
	70I 8B5930709		30I 8B5950309
35	10I 8B5935109		35I 8B5950359
	30I 8B5935309		40I 8B5950409
	35I 8B5935359		45I 8B5950459
	40I 8B5935409		50I 8B5950509
	45I 8B5935459		55I 8B5950559
	50I 8B5935509		35I 8B5955359
	55I 8B5935559		45I 8B5955459
	60I 8B5935609	60	30I 8B5960309
	65I 8B5935659		40I 8B5960409
40	10I 8B5940109	65	30I 8B5965309
	30I 8B5940309	70	10I 8B5970109
	35I 8B5940359		30I 8B5970309
	40I 8B5940409	80	10I 8B5980109
	45I 8B5940459		
	50I 8B5940509		
	55I 8B5940559		
	60I 8B5940609		



## R6 Euro profiel cilinder met gevarenfunctie (GF)

- 6 messingstiften
- Anti-picking met actieve stiften
- 30° DIN cam
- 3 genummerde sleutels
- M5 bevestigingsschroef
- Afbreekbescherming in U-vorm
- Boorbescherming in de body
- SKG\*\* 

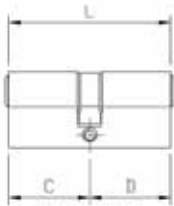

30	30I 8B9930309
	35I 8B9930359
	40I 8B9930409
	45I 8B9930459
	50I 8B9930509
	55I 8B9930559
	60I 8B9930609
	65I 8B9930659
	70I 8B9930709
	75I 8B9930759
35	35I 8B9935359
	40I 8B9935409
	45I 8B9935459
	50I 8B9935509
	55I 8B9935559
	60I 8B9935609
	65I 8B9935659
40	40I 8B9940409
	45I 8B9940459
	50I 8B9940509
	55I 8B9940559
	60I 8B9940609
	65I 8B9940659
45	45I 8B9945459
	50I 8B9945509
	55I 8B9945559
	60I 8B9945609
50	50I 8B9950509
	55I 8B9950559



**R6 Euro profiel cilinder gelijksluitend (KA)**

- 6 messingstiften
- Anti-picking met actieve stiften
- 30° DIN cam
- 3 genummerde sleutels
- M5 bevestigingsschroef
- Afbreekbescherming in U-vorm
- Boorbescherming in de body
- SKG\*\*

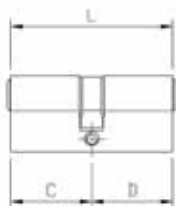

28	28I 885928289	45	10I 8B0945109.8DD
30	10I 8B0930109.8DD		35I 8B5945359.8DD
	30I 885930309		40I 8B5945409.8DD
	35I 8B0930359.8DD		45I 8B0945459.8DD
	40I 8B0930409.8DD		50I 8B0945509.8DD
	45I 8B0930459.8DD		55I 8B0945559.8DD
	50I 8B0930509.8DD		60I 8B0945609.8DD
	55I 8B0930559.8DD	50	10I 8B0950109.8DD
	60I 8B0930609.8DD		40I 8B5950409.8DD
	65I 8B0930659.8DD		45I 8B5950459.8DD
	70I 8B0930709.8DD		50I 8B0950509.8DD
	75I 8B0930759.8DD		55I 8B0950559.8DD
	80I 8B0930809.8DD		60I 8B0950609.8DD
35	10I 8B0935109.8DD	55	10I 8B0955109.8DD
	35I 8B0935359.8DD		30I 8B5955309.8DD
	40I 8B0935409.8DD	60	10I 8B0960109.8DD
	45I 8B0935459.8DD		30I 8B5960309.8DD
	50I 8B0935509.8DD		35I 8B5960359.8DD
	55I 8B0935559.8DD	65	30I 8B5965309.8DD
	60I 8B0935609.8DD	70	10I 8B0970109.8DD
	65I 8B0935659.8DD		30I 8B5970309.8DD
	75I 888935759.8	80	10I 8B0980109.8DD
40	10I 8B0940109.8DD	90	10I 8B0990109.8DD
	40I 8B0940409.8DD		
	45I 8B0940459.8DD		
	50I 8B0940509.8DD		
	55I 8B0940559.8DD		
	60I 8B0940609.8DD		
	65I 8B0940659.8DD		
	70I 8B0940709.8DD		



## R6 Euro profiel knopcilinder (KN) gelijksluitend (KA)

6 messingstiften  
 Anti-picking met actieve stiften  
 30° DIN cam  
 3 genummerde sleutels  
 M5 bevestigingsschroef  
 Afbreekbescherming in U-vorm  
 Boorbescherming in de body  
 SKG\*\* 

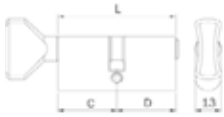

30	30I 8B5930309.8DD	45	30I 8B5945309.8DD
	35I 8B5930359.8DD		45I 8B5945459.8DD
	40I 8B5930409.8DD		50I 8B5945509.8DD
	45I 8B5930459.8DD		55I 8B5945559.8DD
	50I 8B5930509.8DD		60I 8B5945609.8DD
	55I 8B5930559.8DD		65I 8B5945659.8DD
	60I 8B5930609.8DD	50	30I 8B5950309.8DD
	65I 8B5930659.8DD		50I 8B5950509.8DD
	70I 8B5930709.8DD		55I 8B5950559.8DD
	75I 8B5930759.8DD	55	35I 8B5955359.8DD
35	30I 8B5935309.8DD		45I 8B5955459.8DD
	35I 8B5935359.8DD		50I 8B5955509.8DD
	40I 8B5935409.8DD	60	45I 8B5960459.8DD
	45I 8B5935459.8DD	70	35I 8B5970359.8DD
	50I 8B5935509.8DD		
	55I 8B5935559.8DD		
	60I 8B5935609.8DD		
	65I 8B5935659.8DD		
40	30I 8B5940309.8DD		
	35I 8B5940359.8DD		
	40I 8B5940409.8DD		
	45I 8B5940459.8DD		
	50I 8B5940509.8DD		
	55I 8B5940559.8DD		
	60I 8B5940609.8DD		
	70I 8B5940709.8DD		



**R6 Euro profiel cilinder gelijksluitend (KA) met gevarenfunctie (GF)**

- 6 messingstiften
- Anti-picking met actieve stiften
- 30° DIN cam
- 3 genummerde sleutels
- M5 bevestigingsschroef
- Afbreekbescherming in U-vorm
- Boorbescherming in de body
- SKG\*\*

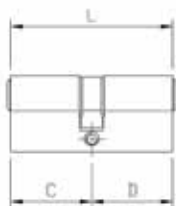

30	30I 8B9930309.8DD	40	40I 8B9940409.8DD
	35I 8B9930359.8DD		45I 8B9940459.8DD
	40I 8B9930409.8DD		50I 8B9940509.8DD
	45I 8B9930459.8DD		55I 8B9940559.8DD
	50I 8B9930509.8DD		60I 8B9940609.8DD
	55I 8B9930559.8DD	45	45I 8B9945459.8DD
	60I 8B9930609.8DD		50I 8B9945509.8DD
	65I 8B9930659.8DD		55I 8B9945559.8DD
	70I 8B9930709.8DD		60I 8B9945609.8DD
	75I 8B9930759.8DD	50	50I 8B9950509.8DD
	80I 8B9930809.8DD		60I 8B9950609.8DD
35	35I 8B9935359.8DD		
	40I 8B9935409.8DD		
	45I 8B9935459.8DD		
	50I 8B9935509.8DD		
	55I 8B9935559.8DD		
	60I 8B9935609.8DD		
	65I 8B9935659.8DD		

**R6 Oplegcilinder**

6 messingstiften

3 genummerde sleutels

Voor een maximale deurdikte van 85mm



---

I 860000857 R6 OPLEGCILINDER KOPER

---

I 860000859 R6 OPLEGCILINDER VERGULD MESSING

# Iseo F9

Veiligheidscilinder

## Sleutel

- Tandgesneden sleutel
- Nikkelsilver sleutel
- Genummerd

## Cilinder

- 6 codestiften in inox
- 4 messing tegenstiften (anti-picking)
- Afbreekbescherming in U-vorm (niet icm MKSYS)
- Boorbescherming in body

## Mogelijkheden

- Verschillend sluitende cilinders (KD)
- Gelijksluitende cilinders (KA)
- Gevarenfunctie (GF)
- Sluitplannen (MK)
- Knopcilinder (KN)
- Oplegcilinder
- Halve cilinder met verstelbare meenemer
- Italiaanse meenemer
- Vrijloopcilinder (VRIJ)
- Tandwielcilinder: 10, 13 of 14 tanden
- Modulaire 'LE60'
- Eigen profiel

## Pluspunten

- Lange sleutelhals
- Merkpatent
- Te combineren met F9000



## F9 Euro profiel cilinder

- 6 messingstiften
- Anti-picking met actieve stiften
- 30° DIN cam
- 3 genummerde sleutels
- M5 bevestigingsschroef
- Afbreekbescherming in U-vorm
- Boorbescherming in de body
- Eigendomscertificaat

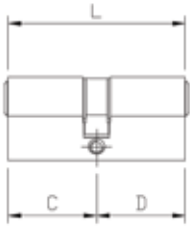

28	28I 82FA028289DD	40	10I 82FA040109DD
	33I 82FA028339DD		40I 82FA040409DD
30	10I 82FA030109DD		45I 82FA040459DD
	30I 82FA030309DD		50I 82FA040509DD
	35I 82FA030359DD		55I 82FA040559DD
	40I 82FA030409DD		60I 82FA040609DD
	45I 82FA030459DD		80I 82FA040809DD
	50I 82FA030509DD	45	10I 82FA045109DD
	55I 82FA030559DD		45I 82FA045459DD
	65I 82FA030659DD		50I 82FA045509DD
	70I 82FA030709DD		55I 82FA045559DD
	75I 82FA030759DD		60I 82FA045609DD
	80I 82FA030809DD	50	10I 82FA050109DD
	85I 82FA030859DD		50I 82FA050509DD
	90I 82FA030909DD		65I 82FA050659DD
35	10I 82FA035109DD	55	65I 82FA055659DD
	35I 82FA035359DD	60	60I 82FA060609DD
	40I 82FA035409DD	70	10I 82FA070109DD
	45I 82FA035459DD	75	10I 82FA075109DD
	50I 82FA035509DD	90	10I 82FA090109DD
	55I 82FA035559DD		
	60I 82FA035609DD		
	65I 82FA035659DD		
	70I 82FA035709DD		
	75I 82FA035759DD		
	85I 82FA035859DD		

**F9 Euro profiel Knopcilinder (KN)**

- 6 messingstiften
- Anti-picking met actieve stiften
- 30° DIN cam
- 3 genummerde sleutels
- M5 bevestigingsschroef
- Afbreekbescherming in U-vorm
- Boorbescherming in de body
- Eigendomscertificaat



<p>30</p> <hr/> <p>30I 82FA830309DD</p> <hr/> <p>35I 82FA830359DD</p> <hr/> <p>40I 82FA830409DD</p> <hr/> <p>45I 82FA830459DD</p> <hr/> <p>50I 82FA830509DD</p> <hr/> <p>55I 82FA830559DD</p> <hr/> <p>60I 82FA830609DD</p> <hr/> <p>70I 82FA830709DD</p> <hr/> <p>35</p> <hr/> <p>30I 82FA835309DD</p> <hr/> <p>35I 82FA835359DD</p> <hr/> <p>40I 82FA835409DD</p> <hr/> <p>45I 82FA835459DD</p> <hr/> <p>50I 82FA835509DD</p> <hr/> <p>60I 82FA835609DD</p> <hr/> <p>40</p> <hr/> <p>30I 82FA840309DD</p> <hr/> <p>35I 82FA840359DD</p> <hr/> <p>40I 82FA840409DD</p> <hr/> <p>45I 82FA840459DD</p> <hr/> <p>50I 82FA840509DD</p> <hr/>	<p>45</p> <hr/> <p>35I 82FA845359DD</p> <hr/> <p>45I 82FA845459DD</p> <hr/> <p>50I 82FA845509DD</p> <hr/> <p>55I 82FA845559DD</p> <hr/> <p>50</p> <hr/> <p>30I 82FA850309DD</p> <hr/> <p>35I 82FA850359DD</p> <hr/> <p>45I 82FA850459DD</p> <hr/> <p>50I 82FA850509DD</p> <hr/> <p>70</p> <hr/> <p>10I 82FA870109DD</p> <hr/> <p>80</p> <hr/> <p>30I 82FA880309DD</p> <hr/>
---	---

## F9 Euro profiel cilinder met gevarenfunctie (GF)

- 6 messingstiften
- Anti-picking met actieve stiften
- 30° DIN cam
- 3 genummerde sleutels
- M5 bevestigingsschroef
- Afbreekbescherming in U-vorm
- Boorbescherming in de body
- Eigendomscertificaat

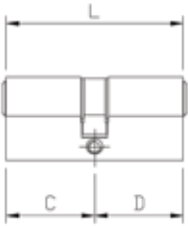

30	30I 82FA930309DD	40	40I 82FA940409DD
	35I 82FA930359DD		45I 82FA940459DD
	40I 82FA930409DD		50I 82FA940509DD
	45I 82FA930459DD		55I 82FA940559DD
	50I 82FA930509DD	45	45I 82FA945459DD
	60I 82FA930609DD		50I 82FA945509DD
	65I 82FA930659DD	50	50I 82FA950509DD
	70I 82FA930709DD	55	60I 82FA955609DD
35	35I 82FA935359DD		
	40I 82FA935409DD		
	45I 82FA935459DD		
	50I 82FA935509DD		
	55I 82FA935559DD		
	60I 82FA935609DD		
	65I 82FA935659DD		
	70I 82FA935709DD		
	75I 82FA935759DD		
	85I 82FA935859DD		

### F9 Euro profiel cilinder gelijksluitend (KA)

- 6 messingstiften
- Anti-picking met actieve stiften
- 30° DIN cam
- 3 genummerde sleutels
- M5 bevestigingsschroef
- Afbreekbescherming in U-vorm
- Boorbescherming in de body
- Eigendomscertificaat

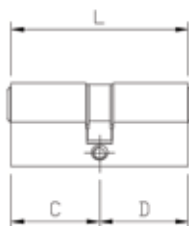

28	28I 82FA028289.8DD	40	10I 82FA040109.8DD
	33I 82FA028339.8DD		40I 82FA040409.8DD
30	10I 82FA030109.8DD		50I 82FA040509.8DD
	30I 82FA030309.8DD		55I 82FA040559.8DD
	35I 82FA030359.8DD		60I 82FA040609.8DD
	45I 82FA030459.8DD		65I 82FA040659.8DD
	50I 82FA030509.8DD		70I 82FA040709.8DD
	55I 82FA030559.8DD		80I 82FA040809.8DD
	60I 82FA030609.8DD	45	10I 82FA045109.8DD
	75I 82FA030759.8DD		45I 82FA045459.8DD
	80I 82FA030809.8DD		50I 82FA045509.8DD
	85I 82FA030859.8DD		55I 82FA045559.8DD
	90I 82FA030909.8DD		60I 82FA045609.8DD
35	10I 82FA035109.8DD	50	10I 82FA050109.8DD
	35I 82FA035359.8DD		50I 82FA050509.8DD
	40I 82FA035409.8DD		60I 82FA050609.8DD
	45I 82FA035459.8DD		65I 82FA050659.8DD
	50I 82FA035509.8DD	60	60I 82FA060609.8DD
	55I 82FA035559.8DD	70	10I 82FA070109.8DD
	60I 82FA035609.8DD	75	10I 82FA075109.8DD
	65I 82FA035659.8DD	80	10I 82FA080109.8DD
	75I 82FA035759.8DD		
	80I 82FA035809.8DD		

## F9 Euro profiel knopcilinder (KN) gelijksluitend (KA)

6 messingstiften  
 Anti-picking met actieve stiften  
 30° DIN cam  
 3 genummerde sleutels  
 M5 bevestigingsschroef  
 Afbreekbescherming in U-vorm  
 Boorbescherming in de body  
 Eigendomscertificaat

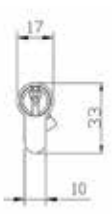
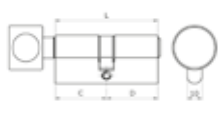

28	28I 82FA828289.8DD	45	35I 82FA845359.8DD
30	30I 82FA830309.8DD	40I 82FA845409.8DD	
	40I 82FA830409.8DD	45I 82FA845459.8DD	
	50I 82FA830509.8DD	50I 82FA845509.8DD	
	55I 82FA830559.8DD	55I 82FA855459.8DD	
	60I 82FA830609.8DD	60I 82FA845609.8DD	
	65I 82FA830659.8DD	50	40I 82FA850409.8DD
	70I 82FA830709.8DD	60I 82FA850609.8DD	
	75I 82FA830759.8DD	65I 82FA850659.8DD	
35	35I 82FA835309.8DD	55	30I 82FA855309.8DD
	40I 82FA835409.8DD	70	30I 82FA870309.8DD
	45I 82FA835459.8DD		
	50I 82FA835509.8DD		
	55I 82FA835559.8DD		
	60I 82FA835609.8DD		
	70I 82FA835709.8DD		
40	30I 82FA840309.8DD		
	35I 82FA840359.8DD		
	40I 82FA840409.8DD		
	45I 82FA840459.8DD		
	50I 82FA840509.8DD		
	55I 82FA840559.8DD		
	60I 82FA840609.8DD		
	65I 82FA840659.8DD		

**F9 Euro profiel cilinder gelijksluitend (KA) met gevarenfunctie (GF)**



- 6 messingstiften
- Anti-picking met actieve stiften
- 30° DIN cam
- 3 genummerde sleutels
- M5 bevestigingsschroef
- Afbreekbescherming in U-vorm
- Boorbescherming in de body
- Eigendomscertificaat



- |       |                    |
|-------|--------------------|
| 30    | 30I 82FA930309.8DD |
| <hr/> |                    |
|       | 35I 82FA930359.8DD |
| <hr/> |                    |
|       | 40I 82FA930409.8DD |
| <hr/> |                    |
|       | 50I 82FA930509.8DD |
| <hr/> |                    |
|       | 55I 82FA930559.8DD |
| <hr/> |                    |
|       | 60I 82FA930609.8DD |
| <hr/> |                    |
|       | 65I 82FA930659.8DD |
| <hr/> |                    |
|       | 70I 82FA930709.8DD |
| <hr/> |                    |
|       | 75I 82FA930759.8DD |
| <hr/> |                    |
|       | 85I 82FA930859.8DD |

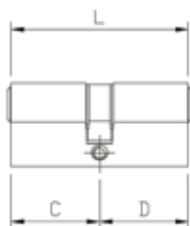

- |       |                    |
|-------|--------------------|
| 35    | 35I 82FA935359.8DD |
| <hr/> |                    |
|       | 40I 82FA935409.8DD |
| <hr/> |                    |
|       | 45I 82FA935459.8DD |
| <hr/> |                    |
|       | 50I 82FA935509.8DD |
| <hr/> |                    |
|       | 55I 82FA935559.8DD |
| <hr/> |                    |
|       | 60I 82FA935609.8DD |
| <hr/> |                    |
|       | 65I 82FA935659.8DD |



- |       |                    |
|-------|--------------------|
| 40    | 40I 82FA940409.8DD |
| <hr/> |                    |
|       | 45I 82FA940459.8DD |
| <hr/> |                    |
|       | 50I 82FA940509.8DD |
| <hr/> |                    |
|       | 55I 82FA940559.8DD |
| <hr/> |                    |
|       | 60I 82FA940609.8DD |
| <hr/> |                    |
| 45    | 45I 82FA945459.8DD |
| <hr/> |                    |
|       | 50I 82FA945509.8DD |
| <hr/> |                    |
|       | 60I 82FA945609.8DD |

**F9 Cam cilinder**

6 messingstiften  
 Anti-picking met actieve stiften  
 3 genummerde sleutels  
 Eigendomscertificaat



I 87FA23F259DD	F9 CAM
I 87FA23F259.8DD	F9 CAM KA 3 SLEUTELS
I 87FA040859DD	F9 STAARTCILINDER

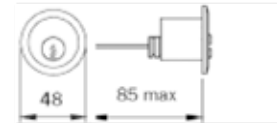
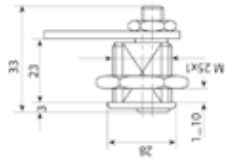

# Iseo R9Plus

Veiligheidscilinder

47

## Sleutel

- Keersleutel
- Nikkelzilver
- Genummerd
- 3mm dikke sleutel

## Cilinder

- 6 codestiften in inox
- Anti-picking met actieve stiften
- 3-lijns codering
- Afbreekbescherming in U-vorm
- Boorbescherming in body en rotor
- Merkpatent
- Gevarenfunctie ( GF)

## Mogelijkheden

- Verschillend sluitende cilinders
- Gelijksluitende cilinders ( KA)
- Gevarenfunctie ( GF)
- Sluitplannen (MK)
- Knopcilinder (KN)
- Oplegcilinder
- Schroefcilinder
- Halve cilinder met verstelbare meenemer
- Italiaanse meenemer
- Vrijloopcilinder (VRIJ)
- Tandwielcilinder: 10, 13 of 14 tanden
- Modulaire 'LE60'
- Eigen profiel

## Pluspunten

- Lange sleutelhals
- Merkpatent



your world safely locked //®

## R9Plus Euro profiel cilinder met gevarenfunctie (GF)



3-lijns hardstaal code stiften  
 Anti-picking door actieve stiften  
 Boorbescherming in rotor en body  
 Afbreekbescherming in U-vorm  
 30° DIN cam  
 3 genummerde sleutels  
 Eigendomscertificaat

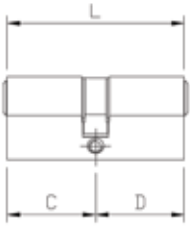

30	10I 82RP030109DD	40	10I 82RP040109DD	
	30I 82RP930309DD		40I 82RP940409DD	
	35I 82RP930359DD		45I 82RP940459DD	
	40I 82RP930409DD		50I 82RP940509DD	
	45I 82RP930459DD		55I 82RP940559DD	
	50I 82RP930509DD		60I 82RP940609DD	
	55I 82RP930559DD	45	10I 82RP045109DD	
	60I 82RP930609DD		45I 82RP945459DD	
	65I 82RP930659DD		50I 82RP945509DD	
	70I 82RP930709DD		55I 82RP945559DD	
	75I 82RP930759DD		60I 82RP945609DD	
	80I 82RP930809DD		65I 82RP945659DD	
35	10I 82RP035109DD	50	50I 82RP950509DD	
	35I 82RP935359DD		55I 82RP950559DD	
	40I 82RP935409DD	55	10I 82RP055109DD	
	45I 82RP935459DD		60	10I 82RP060109DD
	50I 82RP935509DD		65	10I 82RP065109DD
	55I 82RP935559DD		70	10I 82RP070109DD
	60I 82RP935609DD		80	10I 82RP080109DD
	65I 82RP935659DD		90	10I 82RP090109DD
	70I 82RP935709DD			
	75I 82RP935759DD			
	80I 82RP935809DD			
	85I 82RP935859DD			

### R9Plus Euro profiel knopcilinder (KN)

- 3-lijns hardstaal code stiften
- Anti-picking door actieve stiften
- Boorbescherming in rotor en body
- Afbreekbescherming in U-vorm
- 30° DIN cam
- 3 genummerde sleutels
- Eigendomscertificaat



30	30I 82RP830309DD	45	10I 82RP845109DD
<hr/>			
	35I 82RP830359DD		30I 82RP845309DD
<hr/>			
	40I 82RP830409DD		35I 82RP845359DD
<hr/>			
	45I 82RP830459DD		40I 82RP845409DD
<hr/>			
	50I 82RP830509DD		45I 82RP845459DD
<hr/>			
	55I 82RP830559DD		50I 82RP845509DD
<hr/>			
	60I 82RP830609DD		60I 82RP845609DD
<hr/>			
	65I 82RP830659DD	50	30I 82RP850309DD
<hr/>			
	70I 82RP830709DD		35I 82RP850359DD
<hr/>			
	75I 82RP830759DD		45I 82RP850459DD
<hr/>			
	80I 82RP830809DD		55I 82RP850559DD
<hr/>			
35	35I 82RP835359DD		60I 82RP850609DD
<hr/>			
	40I 82RP835409DD	55	35I 82RP855359DD
<hr/>			
	45I 82RP835459DD	60	35I 82RP860359DD
<hr/>			
	50I 82RP835509DD		40I 82RP860409DD
<hr/>			
	55I 82RP835559DD	65	40I 82RP865409DD
<hr/>			
	60I 82RP835609DD		
<hr/>			
	65I 82RP835659DD		
<hr/>			
	70I 82RP835709DD		
<hr/>			
40	30I 82RP840309DD		
<hr/>			
	35I 82RP840359DD		
<hr/>			
	40I 82RP840409DD		
<hr/>			
	45I 82RP840459DD		
<hr/>			
	60I 82RP840609DD		
<hr/>			
	65I 82RP840659.8DD		
<hr/>			





## R9Plus Euro profiel knopcilinder (KN) gelijksluitend (KA)

- 3-lijns hardstaal code stiften
- Anti-picking door actieve stiften
- Boorbescherming in rotor en body
- Afbreekbescherming in U-vorm
- 30° DIN cam
- 3 genummerde sleutels
- Eigendomscertificaat



<p>30</p> <hr/> <p>35I 82RP830359.8DD</p> <hr/> <p>40I 82RP830409.8DD</p> <hr/> <p>45I 82RP830459.8DD</p> <hr/> <p>50I 82RP830509.8DD</p> <hr/> <p>55I 82RP830559.8DD</p> <hr/> <p>65I 82RP830659.8DD</p> <hr/> <p>70I 82RP830709.8DD</p> <hr/> <p>80I 82RP830809.8DD</p> <hr/> <p>35</p> <hr/> <p>35I 82RP835309.8DD</p> <hr/> <p>35I 82RP835359.8DD</p> <hr/> <p>40I 82RP835409.8DD</p> <hr/> <p>45I 82RP835459.8DD</p> <hr/> <p>50I 82RP835509.8DD</p> <hr/> <p>55I 82RP835559.8DD</p> <hr/> <p>60I 82RP835609.8DD</p> <hr/> <p>65I 82RP835659.8DD</p> <hr/> <p>70I 82RP835709.8DD</p> <hr/> <p>40</p> <hr/> <p>30I 82RP840309.8DD</p> <hr/> <p>35I 82RP840359.8DD</p> <hr/> <p>40I 82RP840409.8DD</p> <hr/> <p>45I 82RP840459.8DD</p> <hr/> <p>50I 82RP840509.8DD</p> <hr/> <p>55I 82RP840559.8DD</p> <hr/> <p>60I 82RP840609.8DD</p> <hr/> <p>70I 82RP840709.8DD</p> <hr/>	<p>45</p> <hr/> <p>10I 82RP845109.8DD</p> <hr/> <p>30I 82RP845309.8DD</p> <hr/> <p>35I 82RP845359.8DD</p> <hr/> <p>45I 82RP845459.8DD</p> <hr/> <p>50I 82RP845509.8DD</p> <hr/> <p>55I 82RP845559.8DD</p> <hr/> <p>60I 82RP845609.8DD</p> <hr/> <p>50</p> <hr/> <p>30I 82RP850309.8DD</p> <hr/> <p>35I 82RP850359.8DD</p> <hr/> <p>50I 82RP850509.8DD</p> <hr/> <p>60</p> <hr/> <p>30I 82RP860309.8DD</p> <hr/> <p>35I 82RP860359.8DD</p> <hr/>
---	---

**R9Plus Euro profiel cilinder gelijksluitend (KA) met gevarenfunctie (GF)**



- 3-lijns hardstaal code stiften
- Anti-picking door actieve stiften
- Boorbescherming in rotor en body
- Afbreekbescherming in U-vorm
- 30° DIN cam
- 3 genummerde sleutels
- Eigendomscertificaat

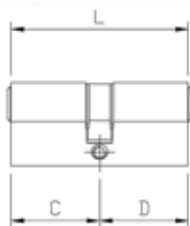

30	10I 82RP030109.8DD	40	10I 82RP040109.8DD
	30I 82RP930309.8DD		40I 82RP940409.8DD
	35I 82RP930359.8DD		45I 82RP940459.8DD
	40I 82RP930409.8DD		50I 82RP940509.8DD
	45I 82RP930459.8DD		55I 82RP940559.8DD
	50I 82RP930509.8DD		60I 82RP940609.8DD
	55I 82RP930559.8DD	45	10I 82RP045109.8DD
	60I 82RP930609.8DD		45I 82RP945459.8DD
	65I 82RP930659.8DD		50I 82RP945509.8DD
	70I 82RP930709.8DD		55I 82RP945559.8DD
	75I 82RP930759.8DD		60I 82RP945609.8DD
	80I 82RP930809.8DD		65I 82RP945659.8DD
35	10I 82RP035109.8DD	50	10I 82RP050109.8DD
	35I 82RP935359.8DD		50I 82RP950509.8DD
	40I 82RP935409.8DD		55I 82RP950559.8DD
	45I 82RP935459.8DD	55	10I 82RP055109.8DD
	50I 82RP935509.8DD		55I 82RP955559.8DD
	60I 82RP935609.8DD		60I 82RP955609.8DD
	65I 82RP935659.8DD	65	10I 82RP065109.8DD
	70I 82RP935709.8DD	80	10I 82RP080109.8DD
	75I 82RP935759.8DD	90	10I 82RP090109.8DD
	80I 82RP935809.8DD		

**R9Plus oplegcilinder**

3-lijns hardstaal code stiften  
 Anti-picking door actieve stiften  
 3 genummerde sleutels  
 Eigendomscertificaat



---

I 87RP040859 R9+ OPLEGCILINDER NIKKEL

---

I 87RP040857 R9+ OPLEGCILINDER KOPER

---

I 87RP23F259 R9+ SCHROEFCILINDER

---

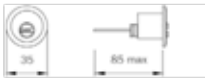
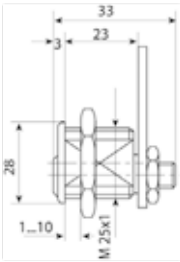

# Iseo R50

Veiligheidscilinder

## Sleutel

- Keersleutel
- Nikkelzilver
- Genummerde sleutels
- 3mm dikke sleutel met actieve stift

## Cilinder

- 11 harstale stiften
- Anti-picking met actieve stiften
- Boorbescherming in body en rotor
- Technische patent

## Mogelijkheden

- Verschillend sluitende cilinders (KD)
- Gelijksluitende cilinders (KA)
- Gevarenfunctie (GF)
- Sluitplannen (MK)
- Knopcilinder (KN)
- Halve cilinder met verstelbare meenemer
- Italiaanse meenemer
- Vrijloopcilinder (VRIJ)
- Tandwielcilinder: 10, 13 of 14 tanden
- Modulaire 'LE60'
- Eigen profiel

## Pluspunten

- Lange sleutelhals
- Merkpatent
- Uittrekbeveiliging tot 7N



your world safely locked //®



## R50 Euro profiel cilinder

11 hardstaal code stiften  
 Max 5 zijdelingse stiften  
 Boorbescherming in rotor en body  
 30° DIN cam  
 3 genummerde sleutels  
 Eigendomscertificaat

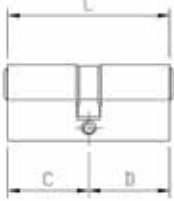

28	28I 8A0928289.13.4	45	10I 8A0945109.13.4
	33I 8A0928339.13.4		45I 8A0945459.13.4
30	10I 8A0930109.13.4		50I 8A0945509.13.4
	30I 8A0930309.13.4		55I 8A0945559.13.4
	35I 8A0930359.13.4		60I 8A0945609.13.4
	40I 8A0930409.13.4		65I 8A0945659.13.4
	45I 8A0930459.13.4		70I 8A0945709.13.4
	50I 8A0930509.13.4	50	10I 8A0950109.13.4
	55I 8A0930559.13.4		50I 8A0950509.13.4
	60I 8A0930609.13.4		55I 8A0950559.13.4
	65I 8A0930659.13.4		60I 8A0950609.13.4
	70I 8A0930709.13.4		65I 8A0950659.13.4
	75I 8A0930759.13.4	55	10I 8A0955109.13.4
	80I 8A0930809.13.4	60	10I 8A0960109.13.4
	90I 8A0930909.13.4	65	10I 8A0965109.13.4
35	10I 8A0935109.13.4		55I 8A0965559.13.4
	35I 8A0935359.13.4	70	10I 8A0970109.13.4
	40I 8A0935409.13.4	80	10I 8A0980109.13.4
	45I 8A0935459.13.4	90	10I 8A0990109.13.4
	50I 8A0935509.13.4		
	55I 8A0935559.13.4		
	60I 8A0935609.13.4		
	65I 8A0935659.13.4		
	70I 8A0935709.13.4		
	75I 8A0935759.13.4		
40	10I 8A0940109.13.4		
	40I 8A0940409.13.4		
	45I 8A0940459.13.4		
	50I 8A0940509.13.4		
	55I 8A0940559.13.4		
	60I 8A0940609.13.4		

### R50 Euro profiel knopcilinder (KN)

11 hardstaal code stiften  
 Max 5 zijdelingse stiften  
 Boorbescherming in rotor en body  
 30° DIN cam  
 3 genummerde sleutels  
 Eigendomscertificaat

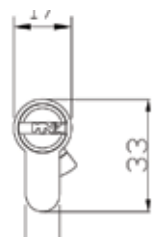
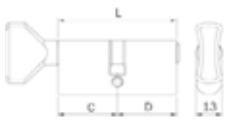

28	28I 8A5928289.13.4	45	10I 8A5945109.13.4
30	10I 8A5930109.13.4		30I 8A5945309.13.4
	30I 8A5930309.13.4		35I 8A5945359.13.4
	35I 8A5930359.13.4		40I 8A5945409.13.4
	40I 8A5930409.13.4		45I 8A5945459.13.4
	45I 8A5930459.13.4	50	30I 8A5950309.13.4
	50I 8A5930509.13.4		35I 8A5950359.13.4
	55I 8A5930559.13.4		40I 8A5950409.13.4
	60I 8A5930609.13.4		45I 8A5950459.13.4
	65I 8A5930659.13.4		50I 8A5950509.13.4
	70I 8A5930709.13.4		60I 8A5950609.13.4
35	10I 8A5935109.13.4	60	40I 8A5960409.13.4
	30I 8A5935309.13.4		50I 8A5960509.13.4
	35I 8A5935359.13.4		
	40I 8A5935409.13.4		
	45I 8A5935459.13.4		
	50I 8A5935509.13.4		
	55I 8A5935559.13.4		
40	10I 8A594010.13.4		
	30I 8A5940309.13.4		
	35I 8A5940359.13.4		
	40I 8A5940409.13.4		
	45I 8A5940459.13.4		
	50I 8A5940509.13.4		
	55I 8A5940559.13.4		
	60I 8A5940609.13.4		



## R50 Euro profiel cilinder met gevarenfunctie (GF)

11 hardstaal code stiften  
 Max 5 zijdelingse stiften  
 Boorbescherming in rotor en body  
 30° DIN cam  
 3 genummerde sleutels  
 Eigendomscertificaat

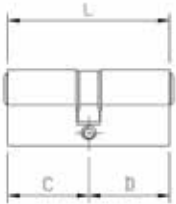

30	30I 8A9930309.13.4	40	40I 8A9940409.13.4
	35I 8A9930359.13.4		45I 8A9940459.13.4
	40I 8A9930409.13.4		50I 8A9940509.13.4
	45I 8A9930459.13.4		55I 8A9940559.13.4
	50I 8A9930509.13.4		60I 8A9940609.13.4
	55I 8A9930559.13.4	45	45I 8A9945459.13.4
	60I 8A9930609.13.4		50I 8A9945509.13.4
	65I 8A9930659.13.4		55I 8A9945559.13.4
	70I 8A9930709.13.4		60I 8A9945609.13.4
35	35I 8A9935359.13.4	50	50I 8A9950509.13.4
	40I 8A9935409.13.4		60I 8A9950609.13.4
	45I 8A9935459.13.4		
	50I 8A9935509.13.4		
	55I 8A9935559.13.4		
	60I 8A9935609.13.4		
	65I 8A9935659.13.4		

**R50 Euro profiel cilinder gelijksluitend (KA)**

11 hardstaal code stiften  
 Max 5 zijdelingse stiften  
 Boorbescherming in rotor en body  
 30° DIN cam  
 3 genummerde sleutels  
 Eigendomscertificaat

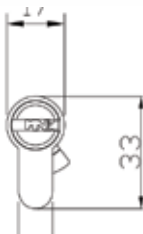
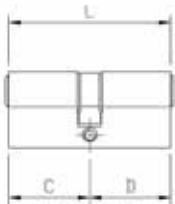

28	28I 8A0928289.13.4.8DD	45	10I 8A0945109.13.4.8DD
	33I 8A0928339.13.4.8DD		45I 8A0945459.13.4.8DD
30	10I 8A0930109.13.4.8DD		50I 8A0945509.13.4.8DD
	30I 8A0930309.13.4.8DD		55I 8A0945559.13.4.8DD
	35I 8A0930359.13.4.8DD		60I 8A0945609.13.4.8DD
	40I 8A0930409.13.4.8DD	50	10I 8A0950109.13.4.8DD
	45I 8A0930459.13.4.8DD		50I 8A0950509.13.4.8DD
	50I 8A0930509.13.4.8DD		55I 8A0950559.13.4.8DD
	55I 8A0930559.13.4.8DD		60I 8A0950609.13.4.8DD
	60I 8A0930609.13.4.8DD	55	10I 8A0955109.13.4.8DD
	65I 8A0930659.13.4.8DD		55I 8A0955559.13.4.8DD
	70I 8A0930709.13.4.8DD	60	10I 8A0960109.13.4.8DD
	75I 8A0930759.13.4.8DD		65I 10I 8A0965109.13.4.8DD
	80I 8A0930809.13.4.8DD		70I 10I 8A0970109.13.4.8DD
	90I 8A0930909.13.4.8DD		80I 10I 8A0980109.13.4.8DD
35	10I 8A0935109.13.4.8DD		90I 10I 8A0990109.13.4.8DD
	35I 8A0935359.13.4.8DD		
	40I 8A0935409.13.4.8DD		
	45I 8A0935459.13.4.8DD		
	50I 8A0935509.13.4.8DD		
	55I 8A0935559.13.4.8DD		
	60I 8A0935609.13.4.8DD		
	65I 8A0935659.13.4.8DD		
	70I 8A0935709.13.4.8DD		
40	10I 8A0940109.13.4.8DD		
	40I 8A0940409.13.4.8DD		
	45I 8A0940459.13.4.8DD		
	50I 8A0940509.13.4.8DD		
	55I 8A0940559.13.4.8DD		
	60I 8A0940609.13.4.8DD		



## R50 Euro profiel knopcilinder (KN) gelijksluitend (KA)

- 11 hardstaal code stiften
- Max 5 zijdelingse stiften
- Boorbescherming in rotor en body
- 30° DIN cam
- 3 genummerde sleutels
- Eigendomscertificaat

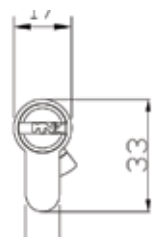
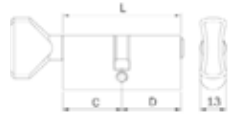

30	30I 8A5930309.13.4.8DD	45	30I 8A5945309.13.4.8DD	
	35I 8A5930359.13.4.8DD		35I 8A5945359.13.4.8DD	
	40I 8A5930409.13.4.8DD		40I 8A5945409.13.4.8DD	
	45I 8A5930459.13.4.8DD		45I 8A5945459.13.4.8DD	
	50I 8A5930509.13.4.8DD		50I 8A5945509.13.4.8DD	
	55I 8A5930559.13.4.8DD		55I 8A5955459.13.4.8DD	
	60I 8A5930609.13.4.8DD	50	30I 8A5950309.13.4.8DD	
	65I 8A5930659.13.4.8DD		35I 8A5950359.13.4.8DD	
	70I 8A5930709.13.4.8DD		40I 8A5950409.13.4.8DD	
	75I 8A5930759.13.4.8DD		45I 8A5950459.13.4.8DD	
	90I 8A5930909.13.4.8DD		50I 8A5950509.13.4.8DD	
35	35I 8A5935359.13.4.8DD		55I 8A5950559.13.4.8DD	
	40I 8A5935409.13.4.8DD	60	30I 8A5960309.13.4.8DD	
	45I 8A5935459.13.4.8DD		80	30I 8A5980309.13.4.8DD
	50I 8A5935509.13.4.8DD			
	55I 8A5935559.13.4.8DD			
	60I 8A5935609.13.4.8DD			
	65I 8A5935659.13.4.8DD			
	70I 8A5935709.13.4.8DD			
40	30I 8A5940309.13.4.8DD			
	35I 8A5940359.13.4.8DD			
	40I 8A5940409.13.4.8DD			
	45I 8A5940459.13.4.8DD			
	50I 8A5940509.13.4.8DD			
	55I 8A5940559.13.4.8DD			
	60I 8A5940609.13.4.8DD			

**R50 Euro profiel cilinder gelijksluitend (KA) met gevarenfunctie (GF)**

11 hardstaal code stiften  
 Max 5 zijdelingse stiften  
 Boorbescherming in rotor en body  
 30° DIN cam  
 3 genummerde sleutels  
 Eigendomscertificaat

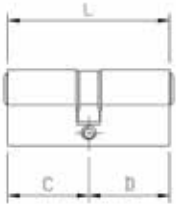

30	30I 8A9930309.13.4.8DD
	35I 8A9930359.13.4.8DD
	40I 8A9930409.13.4.8DD
	45I 8A9930459.13.4.8DD
	50I 8A9930509.13.4.8DD
	55I 8A9930559.13.4.8DD
	60I 8A9930609.13.4.8DD
	65I 8A9930659.13.4.8DD
	70I 8A9930709.13.4.8DD
	80I 8A9930809.13.4.8DD
35	35I 8A9935359.13.4.8DD
	40I 8A9935409.13.4.8DD
	45I 8A9935459.13.4.8DD
	50I 8A9935509.13.4.8DD
	55I 8A9935559.13.4.8DD
	60I 8A9935609.13.4.8DD
	65I 8A9935659.13.4.8DD
	70I 8A9935709.13.4.8DD
40	40I 8A9940409.13.4.8DD
	45I 8A9940459.13.4.8DD
	50I 8A9940509.13.4.8DD
	55I 8A9940559.13.4.8DD
	60I 8A9940609.13.4.8DD
	65I 8A9940659.13.4.8DD
45	45I 8A9945459.13.4.8DD
	50I 8A9945509.13.4.8DD
50	45I 8A9950459.13.4.8DD
	55I 8A9950559.13.4.8DD
	60I 8A9950609.13.4.8DD



your world safely locked //®



**Dombrecht**  
DISTRIBUTION

Info@dombrecht.eu www.dombrecht.eu  
Tel: 052/44 74 84 Fax: 052/44 90 52

Versie v1.1.2

# Iseo Hangsloten

Normale beugel

Praktische, gebruiksvriendelijke en lichte oplossingen voor zowel binnen- als buitengebruik.

Deze hangsloten bieden effectieve beveiliging voor fietsen, poorten, kluisjes etc.

Comfortabel in gebruik en uiterst eenvoudig in gebruik.

Beschikbaar in verschillende configuraties: KD en KA.

- 5 Messing stiften
- Geharde beugel
- Dubbelzijdige sluiting
- 3 sleutels



20mm	P70020127	Hangslot normale beugel
25mm	P70025157	Hangslot normale beugel
30mm	P70030167	Hangslot normale beugel
40mm	P70040217	Hangslot normale beugel
50mm	P70050277	Hangslot normale beugel
60mm	P70060377	Hangslot normale beugel
70mm	P70070427	Hangslot normale beugel

COD.	A	B	C	ØD	E	F	G
P70020127	20	20	10	3.5	13	10	17
P70025157	25	24.5	12	4.2	15	13.5	21.9
P70030167	30	29.5	13	5.1	16	16	26.2
P70040217	40	37	14	6.3	23	22	34.6
P70050277	50	40.5	17	8	29.5	27.5	43.5
P70060377	60	42.5	18.5	9.5	37.5	31.5	50.5
P70070427	70	48	20	11	41	40	62

# Iseo Hangsloten

Verlengde beugel

Hangsloten met lange beugels zijn de ideale oplossing voor het beveiligen van kluisjes, poorten, fietsen en gereedschapskisten en voor andere soortgelijke toepassingen.

Praktisch en gemakkelijk te hanteren, deze hangsloten zijn geschikt voor zowel binnen- als buitengebruik.

Met een messing behuizing zijn lange beugelsloten beschikbaar in de volgende configuraties: KD en KA.

- 5 Messing stiften
- Geharde beugel
- Dubbelzijdige sluiting
- 3 sleutels
- Eenvoudige sluitmechanische

25mm	P70025257	Hangslot verlengde beugel
30mm	P70030467	Hangslot verlengde beugel
40mm	P70040477	Hangslot verlengde beugel
40mm	P0040707	Hangslot extra verlengde beugel
50mm	P70050507	Hangslot extra verlengde beugel



ØD	G	COD.	A	B	C	ØD	E	F	G
		P70025257	25	24,5	12	4,2	25	13,5	21,9
		P70030467	30	29,5	13	5,1	46	16	26,2
		P70040477	40	37	14	6,3	47	22	34,6
		P70040707	40	37	14	6,3	70	22	34,6
		P70050507	50	40,5	17	8	50	27,5	43,5

# Iseo Hangsloten

Marine uitvoering

Marine hangsloten zijn ontworpen en vervaardigd door ISEO om corrosie- en weersbestendigheid te bieden.

Deze zijn met name geschikt voor buitengebruik in natte of regenachtige omstandigheden.

Deze hangsloten zijn vervaardigd van vernikkeld, geborsteld messing en hebben beschermende O-ringen en een conventionele gebogen beugel.

5 Messing stiften  
 Geharde beugel  
 Dubbelzijdige sluiting  
 3 sleutels  
 Eenvoudige sluitmechanische

30mm | 02063007 | Hangslot Marine

40mm | 02064007 | Hangslot Marine

50mm | 02065007 | Hangslot Marine

60mm | 02066007 | Hangslot Marine



ØD	G	COD.	A	B	C	ØD	E	F	G
		02063007	30	29,5	13	5,1	16	16	26,2
		02064007	40	37	14	6,3	23	22	34,6
		02065007	50	40,5	17	8	29,5	27,5	43,5
		02066007	60	42,5	18,5	9,5	37,5	31,5	50,5

# Iseo Veiligheidshangslot

Hangslot voor half profielcilinder

BOXER- en UNIVERSELE hangsloten zijn ontworpen om te worden uitgerust met een enkele profielcilinder, die zelfs bijvoorbeeld dezelfde kan zijn als de cilinder die in de voordeur van de woning is geïnstalleerd. Hiermee kunt u dezelfde sleutel gebruiken om de voordeur van uw huis en de houten schuur in uw tuin te vergrendelen en ontgrendelen. Een keuze uit twee modellen - BOXER en UNIVERSAL - laat u de perfecte oplossing kiezen voor de specifieke toepassing en montage-eisen.

- I 809909                    LUSTUS BOXER CIL 30-10

---

- I 809909I                  LUSTUS BOXER Z/CI

- I 40006000000030    Hangslot 30mm leeg

---

- I 40006000000050    Hangslot 50mm leeg

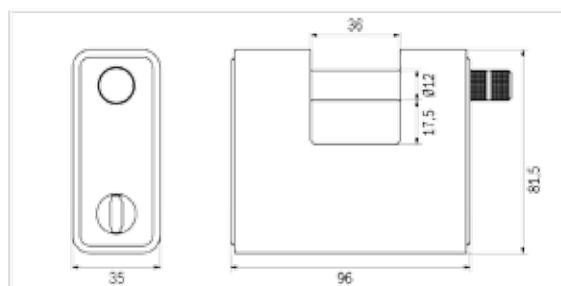
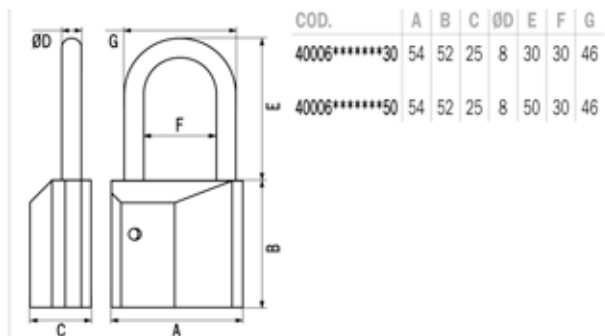

# Iseo Cijferhangslot

Hangslot met cijfer code

## Combinatie hangsloten

De meest praktische oplossing voor het beveiligen van kluisjes, gereedschapskisten enz. Praktisch, omdat ze kunnen worden gebruikt zonder dat u een sleutel bij u hoeft te hebben. Beschikbaar met 3 of 4 cijferige combinatiemechanismen. Monobloklichaam in geanodiseerd aluminium, beugel in gehard verchroomd staal.

Enkel Per 5 te bestellen

C 80444000SC	Hangslot 4 cijfers
C 87322601SC	Hangslot 3 cijfers

I P0153027B	HANGSLOT BLAUW
I P0153027G	HANGSLOT GRIJS
I P0153027R	HANGSLOT ROOD
I P0153027Y	HANGSLOT VIOLET

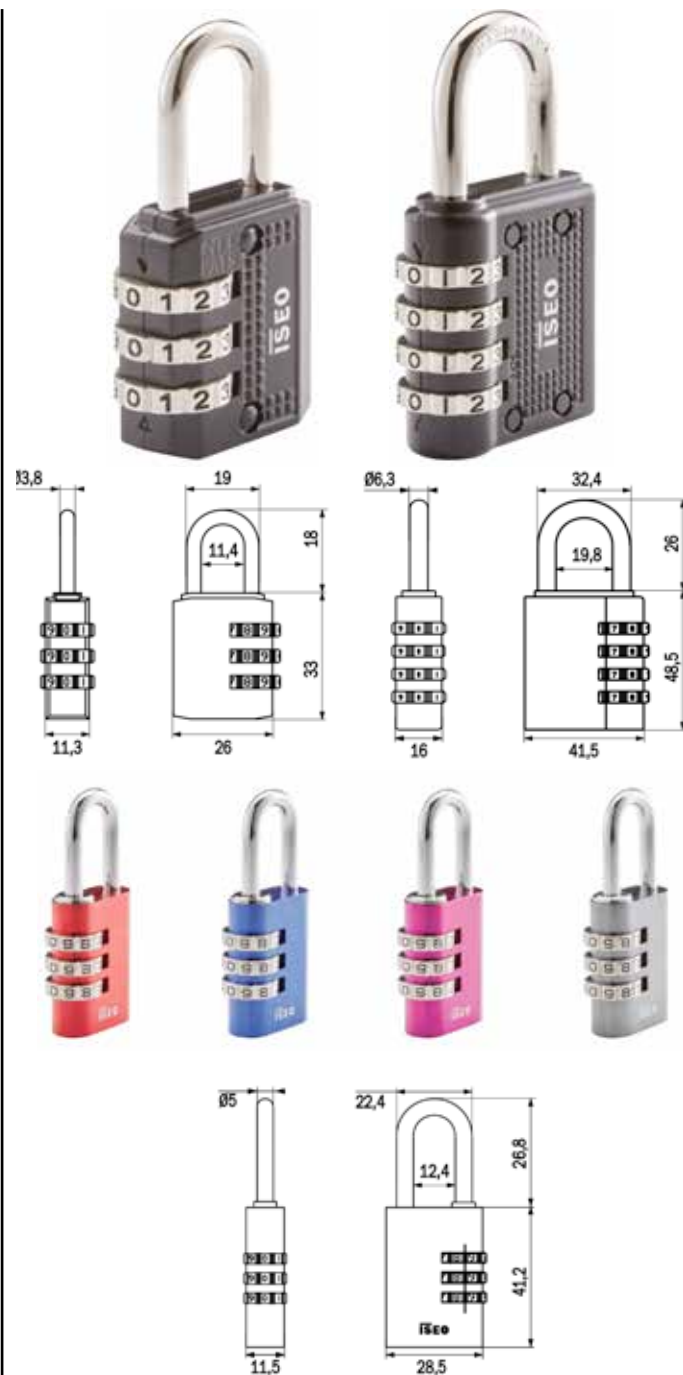



your world safely locked //®



**Dombrecht**  
DISTRIBUTION

Info@dombrecht.eu www.dombrecht.eu  
Tel: 052/44 74 84 Fax: 052/44 90 52

Versie v1.1.2

# Iseo Libra Smart

Elektronische knopcilinder

67

**De libra Smart elektronische cilinder kan eenvoudig worden geïnstalleerd op zowel nieuwe als bestaande deuren.**

Het kan worden gebruikt met elk type mechanisch slot dat compatibel is met de Europese cilinder en vereist geen bedrading, dus het is een vereenvoudiging om de mechanische cilinder om te wisselen naar een elektronische cilinder.

De Libra Smart is ook verkrijgbaar in een HeavyDuty-versie, geschikt voor gebruik onder alle omgevingsomstandigheden en met een beschermd boorsysteem ( op het cilinderhuis) en een breekbeveiliging in U-vorm. Het is de enige cilinder ter wereld met een beschermingsklasse van IP66, IP67(Optie) en IP69(Optie) .

## Mogelijkheden

- Beheer van gebruikers
- Tijdschema's opstellen (2 per gebruiker)
- Tot 300 gebruikers
- Opvragen historiek ( 1000 laatste handelingen)
- Gratis software- upgrades
- Dubbel cilinder
- Halve cilinder
- Dubbel elektronische knop
- Werkt zowel met IOS als Android
- Aanmaken van uitnodigingen
- Modulaire 'LE60'
- Sleuteloverdracht op afstand (optie)
- Dubbel elektronisch op aanvraag

## Pluspunten

- Zeer makkelijk in gebruik
- Eenvoudig te installeren

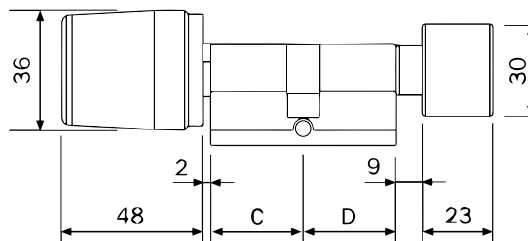



## Libra Smart elektronische knopcilinder IP54

Inox-black  
 1-zijdige bediening  
 30° DIN cam  
 Boorbescherming in rotor  
 Afbreekbescherming in U-vorm  
 Elektronische knop is wisselbaar met binnenzijde

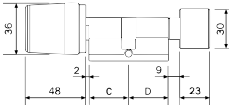

30	10F 82K2030102525	40	75F 82K2840752525
	30F 82K2830302525		80F 82K2840802525
	35F 82K2830352525	45	10F 82K2045102525
	40F 82K2830402525		30F 82K2845302525
	45F 82K2830452525		35F 82K2845352525
	50F 82K2830502525		45F 82K2845452525
	55F 82K2830552525		50F 82K2845502525
	60F 82K2830602525		55F 82K2845552525
	65F 82K2830652525		60F 82K2845602525
	70F 82K2830702525		65F 82K2845652525
	75F 82K2830752525		70F 82K2845702525
	80F 82K2830802525		75F 82K2845752525
	85F 82K2830852525	50	10F 82K2050102525
	90F 82K2830902525		35F 82K2850352525
35	10F 82K2035102525		50F 82K2850502525
	30F 82K2835302525		55F 82K2850552525
	35F 82K2835352525		60F 82K2850602525
	40F 82K2835402525		65F 82K2850652525
	45F 82K2835452525		70F 82K2850702525
	50F 82K2835502525	55	10F 82K2055102525
	55F 82K2835552525		55F 82K2855552525
	60F 82K2835602525		60F 82K2855602525
	65F 82K2835652525		65F 82K2855652525
	70F 82K2835702525	60	10F 82K2060102525
	75F 82K2835752525		60F 82K2860602525
	80F 82K2835802525	65	10F 82K2065102525
	85F 82K2835852525	70	10F 82K2070102525
40	10F 82K2040102525	75	10F 82K2075102525
	40F 82K2840402525	80	10F 82K2080102525
	45F 82K2840452525	85	10F 82K2085102525
	50F 82K2840502525	90	10F 82K2090102525
	55F 82K2840552525		
	60F 82K2840602525		
	65F 82K2840652525		
	70F 82K2840702525		



**Libra Smart elektronische knopcilinder IP66**

Inox-black  
 1-zijdige bediening  
 30° DIN cam  
 Boorbescherming in rotor  
 Afbreekbescherming in U-vorm  
 Elektronische knop is wisselbaar met binnenzijde

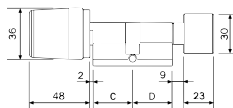

30	10F 82K1030102525	60F 82K1840602525
	30F 82K1830302525	65F 82K1840652525
	35F 82K1830352525	70F 82K1840702525
	40F 82K1830402525	75F 82K1840752525
	45F 82K1830452525	80F 82K1840802525
	50F 82K1830502525	45 10F 82K1045102525
	55F 82K1830552525	40F 82K1845402525
	60F 82K1830602525	45F 82K1845452525
	65F 82K1830652525	50F 82K1845502525
	70F 82K1830702525	55F 82K1845552525
	75F 82K1830752525	60F 82K1845602525
	80F 82K1830802525	65F 82K1845652525
	85F 82K1830852525	70F 82K1845702525
	90F 82K1830902525	75F 82K1845752525
35	10F 82K1035102525	50 10F 82K1050102525
	30F 82K1835302525	30F 82K1850302525
	35F 82K1835352525	45F 82K1850452525
	40F 82K1835402525	50F 82K1850502525
	45F 82K1835452525	55F 82K1850552525
	50F 82K1835502525	60F 82K1850602525
	55F 82K1835552525	65F 82K1850652525
	60F 82K1835602525	70F 82K1850702525
	65F 82K1835652525	55 10F 82K1055102525
	70F 82K1835702525	30F 82K1855302525
	75F 82K1835752525	35F 82K1855352525
	80F 82K1835802525	55F 82K1855552525
	85F 82K1835852525	60F 82K1855602525
40	10F 82K1040102525	65F 82K1855652525
	30F 82K1840302525	60 10F 82K1060102525
	40F 82K1840402525	60 60F 82K1860602525
	45F 82K1840452525	65 10F 82K1065102525
	50F 82K1840502525	70 10F 82K1070102525
	55F 82K1840552525	75 10F 82K1075102525
		80 10F 82K1080102525
		85 10F 82K1085102525
		90 10F 82K1090102525



## Libra Smart Onderdelen



F 5E402001.A      GEBRUIKERSKAARTEN ARGO



F KEYFOB1356MF1      TAG KEY RING MIFARE 1K ISEO LIBRA



F 5E405309.3      MASTER CARD SET(3 ST) ARGO



F 003092      COVER ASSEMBLY-DISASSEMBLY TOOLING KIT



F 003091      LITHIUM BATTERY FOR LIBRA CYLINDER 2/3AA 3,6VCC



F 0444025      COVER KNOP ZWART IP66/IP54 LIBRA



F FXKLIBRAK5SA      LIBRA SMART DISPLAY - ARGO SOFTWARE



F 003044      LIBRA SMART DEMO KIT CASE - ARGO SOFTWARE



F 003316      VERVANGINGSKIT RUBBEREN RING IP66

Aanbevolen gebruik bij vervanging ip66 batterij



F 0000IS00300K1      IC-K4P KEYCOVER FOR ISEO CSF MIFARE 1K

F 0000IS00302K1      IC-K4P KEYCOVER FOR ISEO CSR MIFARE 1K

F 0000IS00300K3      IC-K4P KEYCOVER FOR ISEO CSF DESFIRE EV2 8K

F 0000IS00302K3      IC-K4P KEYCOVER FOR ISEO CSR DESFIRE EV2 8K





your world safely locked //®



**Dombrecht**  
DISTRIBUTION

Info@dombrecht.eu www.dombrecht.eu  
Tel: 052/44 74 84 Fax: 052/44 90 52

Versie v1.1.2

# Iseo Onderdelen

Benodigde onderdelen cilinder

73

## Samenvatting van welke onderdelen

- Montage onderdelen (LE60)
- Bestittingsonderdelen
- Tangen
- Clipsen
- Rotor
- Knoppen
- Meenemers
- Koppelingen
- Sleutels
- Koffers
- Demo standen





your world safely locked //®



**Dombrecht**  
DISTRIBUTION

Info@dombrecht.eu www.dombrecht.eu  
Tel: 052/44 74 84 Fax: 052/44 90 52

Versie v1.1.2

# Iseo F5

Standaardcilinder

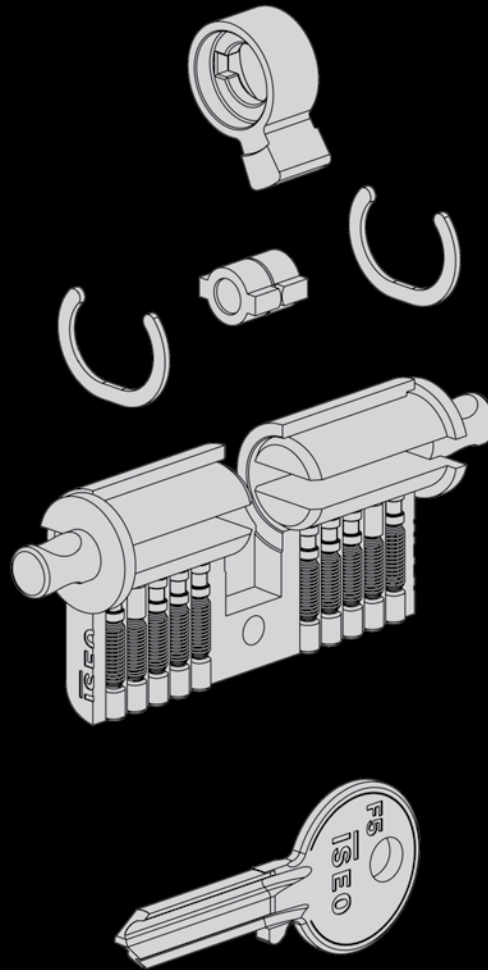

your world safely locked //®

Versie v1.1.2

Info@dombrecht.eu www.dombrecht.eu  
Tel: 052/44 74 84 Fax: 052/44 90 52



**Dombrecht**  
DISTRIBUTION

**F5 Onderdelen**

- Bestifting
- Hulpstukken

76



I 003000 F5 PINNING KIT

---



I 003108 F5 MONTAGE-APPARAAT

---



I 003111 DUWPLAATJE VOOR VEREN/STIFTEN

---



I 003105 SLUITTANG VOOR CILINDER

---



I 003106 PINCET VOOR STIFTEN

---



I 003007 HULPSTUK VOOR CILINDERMONTAGE

---



I 003107 CONTROLEKAART SLEUTELINSNIJDING

---



I 003104 OPENINGSTANG VOOR CILINDER

---



### F5 Onderdelen

- Rotors
- Sleutelverlenging
- Knop kit



I 0045259	F5 ROTOR 30MM	10 stuks
I 0045309	F5 ROTOR 35MM	10 stuks
I 0045359	F5 ROTOR 40MM	10 stuks
I 0045409	F5 ROTOR 45MM	10 stuks
I 0045459	F5 ROTOR 50MM	10 stuks
I 0045509	F5 ROTOR 55MM	10 stuks
I 0045559	F5 ROTOR 60MM	10 stuks
I 0045609	F5 ROTOR 65MM	10 stuks
I 0045659	F5 ROTOR 70MM	10 stuks
I 0045709	F5 ROTOR 75MM	10 stuks
I 0045759	F5 ROTOR 80MM	10 stuks
I 0045859	F5 ROTOR 90MM	10 stuks
I 0045909	F5 ROTOR 95MM	10 stuks

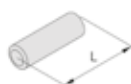

I 003211	KIT EXTENSION ROTOR 5MM	10 stuks
I 003212	KIT EXTENSION ROTOR 10MM	10 stuks
I 003213	KIT EXTENSION ROTOR 15MM	10 stuks
I 003214	KIT EXTENSION ROTOR 20MM	10 stuks
I 003215	KIT EXTENSION ROTOR 25MM	10 stuks
I 003216	KIT EXTENSION ROTOR 30MM	10 stuks
I 003217	KIT EXTENSION ROTOR 35MM	10 stuks
I 003218	KIT EXTENSION ROTOR 40MM	10 stuks



I 003191	KIT ROTOR KN SIDE 30MM	10 stuks
I 003192	KIT ROTOR KN SIDE 35MM	10 stuks
I 003193	KIT ROTOR KN SIDE 40MM	10 stuks
I 003194	KIT ROTOR KN SIDE 45MM	10 stuks
I 003195	KIT ROTOR KN SIDE 50MM	10 stuks

## F5 Onderdelen

- Meenemers
- Clipsen



I 003250	F5 KIT MEENEMER 30/30	10 stuks
----------	-----------------------	----------



I 0033210	KIT GEVARENF F5 30/30	10 stuks
-----------	-----------------------	----------

I 0033211	KIT GEVARENF F5 30/35	10 stuks
-----------	-----------------------	----------

I 0033212	KIT GEVARENF F5 35/35	10 stuks
-----------	-----------------------	----------



I 003196	KIT CLUTCH KN KEY SIDE 30MM	10 stuks
----------	-----------------------------	----------

I 003197	KIT CLUTCH KN KEY SIDE 35MM	10 stuks
----------	-----------------------------	----------

I 003198	KIT CLUTCH KN KEY SIDE 40MM	10 stuks
----------	-----------------------------	----------

I 003199	KIT CLUTCH KN KEY SIDE 45MM	10 stuks
----------	-----------------------------	----------

I 003200	KIT CLUTCH KN KEY SIDE 50MM	10 stuks
----------	-----------------------------	----------

I 003201	KIT CLUTCH KN KEY SIDE 55MM	10 stuks
----------	-----------------------------	----------

I 003202	KIT CLUTCH KN KEY SIDE 60MM	10 stuks
----------	-----------------------------	----------

I 003255	KIT CLUTCH KN KEY SIDE 65MM	10 stuks
----------	-----------------------------	----------

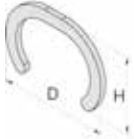

I 0037001	TUSSENRING	250 stuks
-----------	------------	-----------

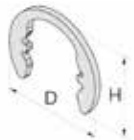

I 0037011	F5 PLUG CLIP	250 stuks
-----------	--------------	-----------



I 0037121	PLUG CLIP KN	250 stuks
-----------	--------------	-----------

**F5 Onderdelen**

- Bestifting



I 0032050	F5/LUSTUS KIT STIFTEN 2.8X5.0MM STEP 0	1000 stuks
I 0032054	F5/LUSTUS KIT STIFTEN 2.8X5.4MM STEP 1	1000 stuks
I 0032058	F5/LUSTUS KIT STIFTEN 2.8X5.8MM STEP 2	1000 stuks
I 0032062	F5/LUSTUS KIT STIFTEN 2.8X6.2MM STEP 3	1000 stuks
I 0032066	F5/LUSTUS KIT STIFTEN 2.8X6.6MM STEP 4	1000 stuks
I 0032070	F5/LUSTUS KIT STIFTEN 2.8X7.0MM STEP 5	1000 stuks
I 0032074	F5/LUSTUS KIT STIFTEN 2.8X7.4MM STEP 6	1000 stuks
I 0032078	F5/LUSTUS KIT STIFTEN 2.8X7.8MM STEP 7	1000 stuks
I 0032082	F5/LUSTUS KIT STIFTEN 2.8X8.2MM STEP 8	1000 stuks

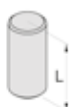

I 0033030	F5 KIT VOLLE STIFT 2.8X3MM	1000 stuks
I 0033050	F5 KIT VOLLE STIFT 2.8X5MM	1000 stuks



I 0034030	F5 KIT VOLLE STIFT 2.8X3MM	1000 stuks
I 0034050	F5 KIT VOLLE STIFT 2.8X5MM	1000 stuks



I 0039008	F5 KIT STIFTEN 2.8X0.8MM STEP 2	1000 stuks
I 0039012	F5 KIT STIFTEN 2.8X1.2MM STEP 3	1000 stuks
I 0039016	F5 KIT STIFTEN 2.8X1.6MM STEP 4	1000 stuks
I 0039020	F5 KIT STIFTEN 2.8X2.0MM STEP 5	1000 stuks
I 0039024	F5 KIT STIFTEN 2.8X2.4MM STEP 6	1000 stuks
I 0039028	F5 KIT STIFTEN 2.8X2.8MM STEP 7	1000 stuks
I 0039032	F5 KIT STIFTEN 2.8X3.2MM STEP 8	1000 stuks



I 0035038	F5 KIT PLUG 3.1X3.2MM	1000 stuks
I 0035049	F5 KIT PLUG 3.1X4.5MM	1000 stuks



I 0038073	F5 KIT VEERTJE D2.8X7.3MM	1000 stuks
I 0038130	F5 KIT VEERTJE D2.8X13MM	1000 stuks

Voor sluitplannen

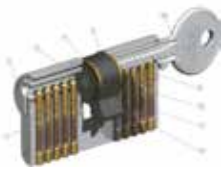
**F5 Onderdelen**  
 - Meenemers

I 003132	KIT DIN CAM MEENEMER	10 stuks
----------	----------------------	----------



I 003151	F5/F6 KIT CAM ITALIAANSE MEENEMER	100 stuks
----------	-----------------------------------	-----------



I 003184	F5 KIT 30°DIN CAM MEENEMER	100 stuks
----------	----------------------------	-----------



I 003153	F5 KIT 30°DIN CAM MEENEMER	100 stuks
----------	----------------------------	-----------



I 003164	F5 KIT CAM MEENEMER HALF CILINDER	100 stuks
----------	-----------------------------------	-----------



I 003155	R6/R7 KIT 30°DIN CAM MEENEMER	100 stuks
----------	-------------------------------	-----------



I 003157	R6/R7 KIT 30°DIN CAM MEENEMER	100 stuks
----------	-------------------------------	-----------



I 003225	R6/R7 KIT 30°DIN CAM MEENEMER	100 stuks
----------	-------------------------------	-----------

### F5 Onderdelen

- Knoppen



I 044179	RONDE KNOP 30MM NIKKEL MET VINGERINLEG	1 stuk
I 044177	RONDE KNOP 30MM KOPER	1 stuk

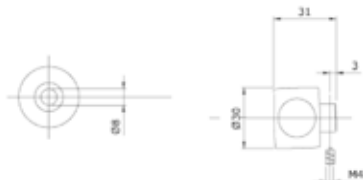

I 044169	PLATTE KNOP 35MM VLEUGEL NIKKEL	1 stuk
I 044167	PLATTE KNOP 35MM VLEUGEL KOPER	1 stuk

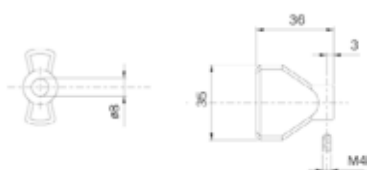

I 044149	DRIEHOEKIGE KNOP 40MM NIKKEL	1 stuk
I 044147	DRIEHOEKIGE KNOP 40MM KOPER	1 stuk



I 044119	RONDE KNOP 30MM NIKKEL	1 stuk
I 044117	RONDE KNOP 30MM KOPER	1 stuk



**F5 Onderdelen**

- Sleutels

82



I 020149	F5 KEY BLANK 30MM Voor hangslot 30mm
----------	--------------------------------------

I 020149-IS	F5 CUTTED KEY 30MM Voor hangslot 30mm
-------------	---------------------------------------

I 020159	F5 KEY BLANK 40MM voor hangslot 40mm
----------	--------------------------------------

I 020159-IS	F5 CUTTED KEY 40MM voor hangslot 40mm
-------------	---------------------------------------

I 020159-ISN	F5 CUTTED KEY 40MM voor hangslot 40mm
--------------	---------------------------------------

I 020239	F5 KEY BLANK 21/21
----------	--------------------

I 020239-IS	F5 CUTTED KEY 21/21
-------------	---------------------

I 020249	F5 KEY BLANK 25/25
----------	--------------------

I 020259.U	F5 KEY BLANK STANDARD
------------	-----------------------

I 020259.U-IS	F5 CUTTED KEY ( Bij cilinder)
---------------	-------------------------------

I 020259.U-ISN	F5 CUTTED KEY LCE ( Nabestelling)
----------------	-----------------------------------

# Iseo F6

Zekerheids Cilinder

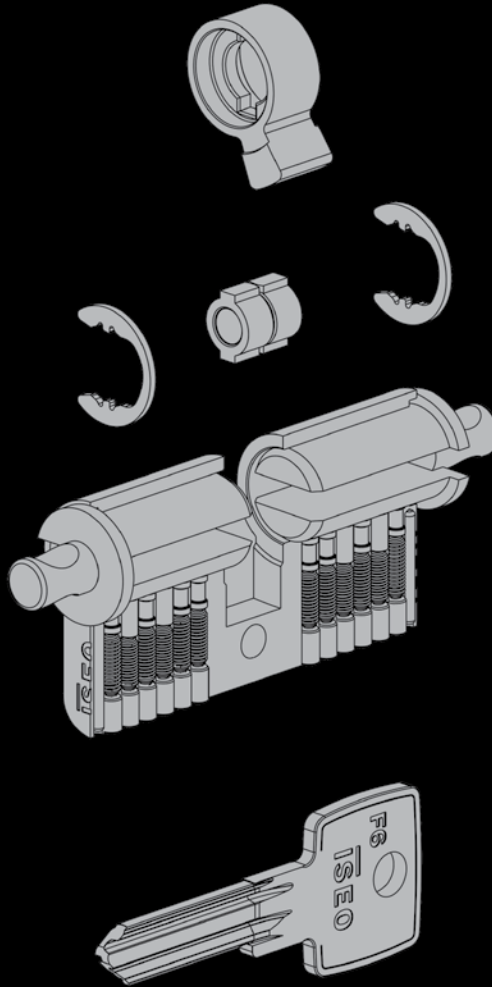

your world safely locked //®

Versie v1.1.2

Info@dombrecht.eu www.dombrecht.eu  
Tel: 052/44 74 84 Fax: 052/44 90 52



**Dombrecht**  
DISTRIBUTION

**F6 Onderdelen**

---

- Bestifting
- Benodigdheden
- Gereedschappen



I 003031 F6 KIT MONTAGE

---



I 003109 F6 MONTAGE-APPARAAT

---



I 003111 DUWPLAATJE VOOR VEREN/STIFTEN

---



I 003104 OPENINGSTANG VOOR CILINDER

---



I 003105 SLUITTANG VOOR CILINDER

---



I 003106 PINCET VOOR STIFTEN

---



I 003007 HULPSTUK VOOR CILINDERMONTAGE

---



### F6 Onderdelen

- Rotors
- Sleutelverlenging
- Knop kit



I 003211	KIT EXTENSION ROTOR 5MM	10 stuks
I 003212	KIT EXTENSION ROTOR 10MM	10 stuks
I 003213	KIT EXTENSION ROTOR 15MM	10 stuks
I 003214	KIT EXTENSION ROTOR 20MM	10 stuks
I 003215	KIT EXTENSION ROTOR 25MM	10 stuks
I 003216	KIT EXTENSION ROTOR 30MM	10 stuks
I 003217	KIT EXTENSION ROTOR 35MM	10 stuks
I 003218	KIT EXTENSION ROTOR 40MM	10 stuks



I 003191	KIT ROTOR KN SIDE 30MM	10 stuks
I 003192	KIT ROTOR KN SIDE 35MM	10 stuks
I 003193	KIT ROTOR KN SIDE 40MM	10 stuks
I 003194	KIT ROTOR KN SIDE 45MM	10 stuks
I 003195	KIT ROTOR KN SIDE 50MM	10 stuks
I 003262	KIT ROTOR KN SIDE 55MM	10 stuks
I 003203	KIT ROTOR KN SIDE 60MM	10 stuks



I 003250	F6 KIT MEENEMER 30/30	10 stuks
----------	-----------------------	----------



I 0033210	KIT GEVARENF F6 30/30	10 stuks
I 0033211	KIT GEVARENF F6 30/35	10 stuks
I 0033212	KIT GEVARENF F6 35/35	10 stuks



I 003267	KOPPELING VR KNOPCIL F/R SERIE SL. ZIJDE 30 MM	10 stuks
I 003269	KOPPELING VR KNOPCIL F/R SERIE SL. ZIJDE 35 MM	10 stuks



I 0037001	TUSSENRING	250 stuks
-----------	------------	-----------

**F6 Onderdelen**

- Meenemers
- Clipsen

I 0037011	F6 PLUG CLIP	250 stuks
I 0037121	PLUG CLIP KN	250 stuks
I 0032146	KIT CODESTIFTEN 2.5X4.6MM F6 STEP 0	1000 stuks
I 0032151	KIT CODESTIFTEN 2.5X5.1MM F6 STEP 1	1000 stuks
I 0032156	KIT CODESTIFTEN 2.5X5.6MM F6 STEP 2	1000 stuks
I 0032161	KIT CODESTIFTEN 2.5X6.1MM F6 STEP 3	1000 stuks
I 0032166	KIT CODESTIFTEN 2.5X6.6MM F6 STEP 4	1000 stuks
I 0032171	KIT CODESTIFTEN 2.5X7.1MM F6 STEP 5	1000 stuks
I 0032176	KIT CODESTIFTEN 2.5X7.6MM F6 STEP 6	1000 stuks
I 0032181	KIT CODESTIFTEN 2.5X8,1MM STEP 7	1000 stuks
I 0032186	KIT CODESTIFTEN 2.5X8,6MM STEP 8	1000 stuks
I 0033150	F6 KIT VOLLE TEGENSTIFT 2.5X5.6MM	1000 stuks
I 0033160	F6 KIT VOLLE TEGENSTIFT 2.5X3.5MM	1000 stuks
I 0034150	F6 KIT PADDESTOELSTIFT 2.5X5.0MM	1000 stuks
I 0034160	F6 KIT PADDESTOELSTIFT 2.5X3.5MM	1000 stuks
I 0039110	F6 KIT STIFTEN 2.5X1.0MM STEP 2	1000 stuks
I 0039115	F6 KIT STIFTEN 2.5X1.5MM STEP 3	1000 stuks
I 0039120	F6 KIT STIFTEN 2.5X2.0MM STEP 4	1000 stuks
I 0039125	F6 KIT STIFTEN 2.5X2.5MM STEP 5	1000 stuks
I 0039130	F6 KIT STIFTEN 2.5X3.0MM STEP 6	1000 stuks
I 0039135	F6 KIT STIFTEN 2.5X3.5MM STEP 7	1000 stuks
I 0039140	F6 KIT STIFTEN 2.5X4.0MM STEP 8	1000 stuks
I 0035136	PLUG CONE-SHAPED 2,8X3,6MM	1000 stuks
I 0038135	KIT VEERTJE D2.5X13.5MM	1000 stuks
I 0038084	F6 KIT VEERTJE D2.5X8.3MM	1000 stuks

### F6 Onderdelen

- Bestifting



I 044179	RONDE KNOP 30MM NIKKEL MET VINGERINLEG	1 stuk
I 044177	RONDE KNOP 30MM KOPER	1 stuk

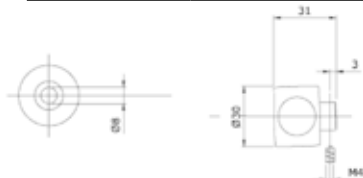

I 044167	PLATTE KNOP 35MM VLEUGEL KOPER	1 stuk
I 044169	PLATTE KNOP 35MM VLEUGEL NIKKEL	1 stuk

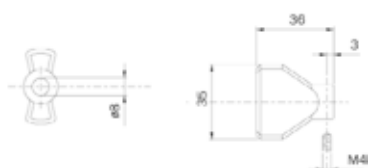

I 044149	DRIEHOEKIGE KNOP 40MM NIKKEL	1 stuk
I 044147	DRIEHOEKIGE KNOP 40MM KOPER	1 stuk



I 044119	RONDE KNOP 30MM NIKKEL	1 stuk
I 044117	RONDE KNOP 30MM KOPER	1 stuk



I 0206098	SET MOEDERSLEUTELS F6	1 stuk
-----------	-----------------------	--------



I 020609.U	F6 KEY ONE SIZE NEUTRAL
I 020609.U-IS	F6 CUTTED ONE SIZE NEUTRAL VBE ( bij cilinder)
I 020609.U-ISN	F6 CUTTED ONE SIZE NEUTRAL VBE ( nabestelling)

**F6 Onderdelen**

- Salto 0
- Volledige cilinder, bestift op 0 stiften
- Ideaal voor cilinders KA te maken

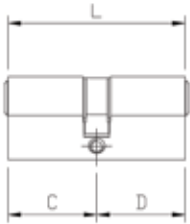

---

 30 10I 810930109.5SALTO0
 

---

 30I 810930309.5SALTO0
 

---

 35I 810930359.5SALTO0
 

---

 40I 810930409.5SALTO0
 

---

 45I 810930459.5SALTO0
 

---

 50I 810930509.5SALTO0
 

---

 60I 810930609.5SALTO0
 

---

 35 35I 810935359.5SALTO0
 

---

 40I 810935409.5SALTO0
 

---

 45I 810935459.5SALTO0
 

---

 50I 810935509.5SALTO0
 

---

 55I 810935559.5SALTO0
 

---

 40 40I 810940409.5SALTO0
 

---

 45I 810940459.5SALTO0
 

---

 45 45I 810945459.5SALTO0
 

---

 50I 810945509.5SALTO0
 

---

 55I 810945559.5SALTO0
 

---

 60I 810945609.5SALTO0
 

---

 50 50I 810950509.5SALTO0
 

---

# Iseo R6

Zekerheids Cilinder

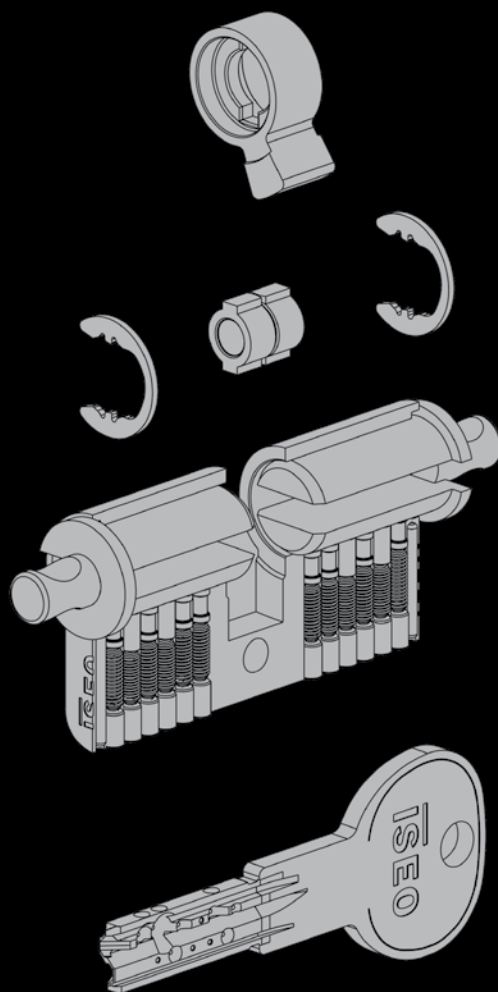

your world safely locked //®

Versie v1.1.2

Info@dombrecht.eu www.dombrecht.eu  
Tel: 052/44 74 84 Fax: 052/44 90 52



**Dombrecht**  
DISTRIBUTION

**R6 Onderdelen**

- Bestifting
- Benodigheden
- Gereedschappen



I 003031 R6 KIT MONTAGE



I 003109 R6 MONTAGE-APPARAAT



I 003111 DUWPLAATJE VOOR VEREN/STIFTEN



I 003104 OPENINGSTANG VOOR CILINDER



I 003105 SLUITTANG VOOR CILINDER



I 003106 PINCET VOOR STIFTEN



I 003007 HULPSTUK VOOR CILINDERMONTAGE



I 003113 HULPSTUK AFLEZEN SLEUTELDIEPTE

### R6 Onderdelen

- Rotors
- Sleutelverlengingen



I 0046259.SK	R6 ROTOR 30MM SKG	10 stuks
I 0046309.SK	R6 ROTOR 35MM SKG	10 stuks
I 0046359.SK	R6 ROTOR 40MM SKG	10 stuks
I 0046409.SK	R6 ROTOR 45MM SKG	10 stuks
I 0046459.SK	R6 ROTOR 50MM SKG	10 stuks
I 0046509.SK	R6 ROTOR 55MM SKG	10 stuks
I 0046559.SK	R6 ROTOR 60MM SKG	10 stuks
I 0046609.SK	R6 ROTOR 65MM SKG	10 stuks
I 0046659.SK	R6 ROTOR 70MM SKG	10 stuks
I 0046709.SK	R6 ROTOR 75MM SKG	10 stuks
I 0046759.SK	R6 ROTOR 80MM SKG	10 stuks
I 0046859.SK	R6 ROTOR 90MM SKG	10 stuks



I 003211	KIT EXTENSION ROTOR 5MM	10 stuks
I 003212	KIT EXTENSION ROTOR 10MM	10 stuks
I 003213	KIT EXTENSION ROTOR 15MM	10 stuks
I 003214	KIT EXTENSION ROTOR 20MM	10 stuks
I 003215	KIT EXTENSION ROTOR 25MM	10 stuks
I 003216	KIT EXTENSION ROTOR 30MM	10 stuks
I 003217	KIT EXTENSION ROTOR 35MM	10 stuks
I 003218	KIT EXTENSION ROTOR 40MM	10 stuks



I 003191	KIT ROTOR KN SIDE 30MM	10 stuks
I 003192	KIT ROTOR KN SIDE 35MM	10 stuks
I 003193	KIT ROTOR KN SIDE 40MM	10 stuks
I 003194	KIT ROTOR KN SIDE 45MM	10 stuks
I 003195	KIT ROTOR KN SIDE 50MM	10 stuks
I 003262	KIT ROTOR KN SIDE 55MM	10 stuks
I 003203	KIT ROTOR KN SIDE 60MM	10 stuks
I 003204	KIT ROTOR KN SIDE 65MM	10 stuks
I 003205	KIT ROTOR KN SIDE 80MM	10 stuks



## R6 Onderdelen

- Rotors
- Meenemers
- Clipsen



I 0033220	KIT CLUTCH GF 30-30	10 stuks
I 0033221	KIT CLUTCH GF 30-35	10 stuks
I 0033222	KIT CLUTCH GF 35-35	10 stuks



I 003187	KIT CLUTCH KN KEY SIDE 30MM	10 stuks
I 003188	KIT CLUTCH KN KEY SIDE 35MM	10 stuks



I 0037001	TUSSENRING	250 stuks
-----------	------------	-----------



I 0037011	R6 PLUG CLIP	250 stuks
-----------	--------------	-----------

I 0037021	STAAL CLIPS VOOR R6	250 stuks
-----------	---------------------	-----------



I 0037121	PLUG CLIP KN	250 stuks
-----------	--------------	-----------



I 0032151	KIT CODESTIFTEN 2.5X5.1MM R6 STEP 0	1000 stuks
I 0032156	KIT CODESTIFTEN 2.5X5.6MM R6 STEP 1	1000 stuks
I 0032161	KIT CODESTIFTEN 2.5X6.1MM R6 STEP 2	1000 stuks
I 0032166	KIT CODESTIFTEN 2.5X6.6MM R6 STEP 3	1000 stuks
I 0032171	KIT CODESTIFTEN 2.5X7.1MM R6 STEP 4	1000 stuks
I 0032176	KIT CODESTIFTEN 2.5X7.6MM R6 STEP 5	1000 stuks



I 0033150	R6 KIT VOLLE TEGENSTIFT 2.5X5.6MM	1000 stuks
I 0033160	R6 KIT VOLLE TEGENSTIFT 2.5X3.5MM	1000 stuks



I 0034150	R6 KIT PADDESTOELSTIFT 2.5X5.0MM	1000 stuks
I 0034160	R6 KIT PADDESTOELSTIFT 2.5X3.5MM	1000 stuks

**R6 Onderdelen**

- Bestifting



I 0039110	R6 KIT STIFTEN 2.5X1.0MM STEP 2	1000 stuks
I 0039115	R6 KIT STIFTEN 2.5X1.5MM STEP 3	1000 stuks
I 0039120	R6 KIT STIFTEN 2.5X2.0MM STEP 4	1000 stuks
I 0039125	R6 KIT STIFTEN 2.5X2.5MM STEP 5	1000 stuks
I 0039130	R6 KIT STIFTEN 2.5X3.0MM STEP 6	1000 stuks
I 0039135	R6 KIT STIFTEN 2.5X3.5MM STEP 7	1000 stuks
I 0039140	R6 KIT STIFTEN 2.5X4.0MM STEP 8	1000 stuks



I 0035136	PLUG CONE-SHAPED 2,8X3,6MM	1000 stuks
-----------	----------------------------	------------



I 0038135	KIT VEERTJE D2.5X13.5MM	1000 stuks
I 0038084	R6 KIT VEERTJE D2.5X8.3MM	1000 stuks

I 044179	RONDE KNOP 30MM NIKKEL MET VINGERINLEG	1 stuks
I 044177	RONDE KNOP 30MM KOPER	1 stuks

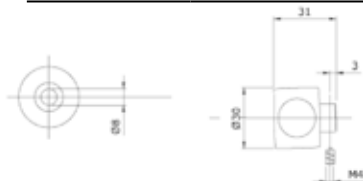

I 044169	PLATTE KNOP 35MM VLEUGEL NIKKEL	1 stuks
I 044167	PLATTE KNOP 35MM VLEUGEL KOPER	1 stuks



I 044149	DRIEHOEKIGE KNOP 40MM NIKKEL	1 stuks
I 044147	DRIEHOEKIGE KNOP 40MM KOPER	1 stuks



I 044119	RONDE KNOP 30MM NIKKEL	1 stuks
I 044117	RONDE KNOP 30MM KOPER	1 stuks



your world safely locked //®

**R6 Onderdelen**

- Knoppen
- Sleutels



I 020870 R6 KEY SET MOEDERSLEUTELS

---



I 020839.U R6 KEY BLANK ABF/AGL

---

I 020819 R6 KEY PLUS AMB

---

I 020819-ISN R6 CUTTED KEY PLUS AMB (Nabestelling)

---

I 020839.U-IS R6 CUTTED KEY (Bij cilinder)

---

I 020839.U-ISN R6 CUTTED KEY ABF/AGL ( Nabestelling)

---

# Iseo F9

Veiligheidscilinder

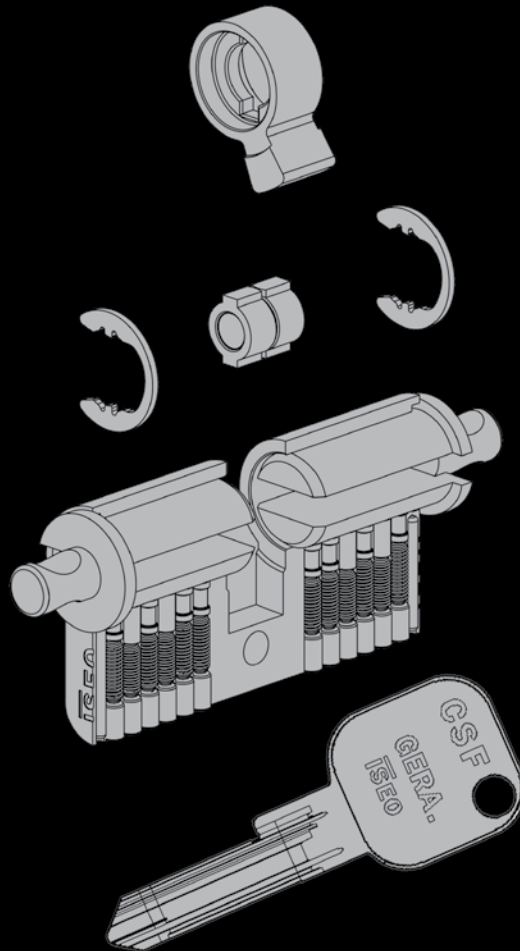

your world safely locked //®

Versie v1.1.2

Info@dombrecht.eu www.dombrecht.eu  
Tel: 052/44 74 84 Fax: 052/44 90 52



**Dombrecht**  
DISTRIBUTION



## F9 Onderdelen

- Bestifting
- Benodigdheden
- Gereedschappen



I 003045 BESTIFTINGSVALIES CSR-CSF



I 003109 CSF/CSR MONTAGE-APPARAAT



I 003111 DUWPLAATJE VOOR VEREN/STIFTEN



I 003104 OPENINGSTANG VOOR CILINDER



I 003105 SLUITTANG VOOR CILINDER



I 003106 PINCET VOOR STIFTEN



I 003007 HULPSTUK VOOR CILINDERMONTAGE

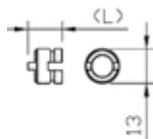

I 003280 KERNVERLENGING 5 MM 10 stuks

I 003281 KERNVERLENGING 10 MM 10 stuks

I 003282 KERNVERLENGING 15MM 10 stuks

I 003283 KERNVERLENGING 20MM 10 stuks

I 003284 KERNVERLENGING 25MM 10 stuks

I 003285 KERNVERLENGING 30MM 10 stuks

### F9 Onderdelen

- Sleutelverlenging
- Meenemers
- Knop kit



I 003211	KIT EXTENSION ROTOR 5MM	10 stuks
I 003212	KIT EXTENSION ROTOR 10MM	10 stuks
I 003213	KIT EXTENSION ROTOR 15MM	10 stuks
I 003214	KIT EXTENSION ROTOR 20MM	10 stuks
I 003215	KIT EXTENSION ROTOR 25MM	10 stuks
I 003216	KIT EXTENSION ROTOR 30MM	10 stuks
I 003217	KIT EXTENSION ROTOR 35MM	10 stuks
I 003218	KIT EXTENSION ROTOR 40MM	10 stuks



I 003250	KIT MEENEMER CSF 30/30	10 stuks
I 003251	KIT MEENEMER CSF VOOR 28MM	10 stuks
I 003252	KIT MEENEMER CSF VOOR 28-33MM	10 stuks



I 0033210	KIT GEVARENF 30/30	10 stuks
I 0033211	KIT GEVARENF 30/35	10 stuks
I 0033212	KIT GEVARENF 35/35	10 stuks



I 003261	KIT ROTOR KN SIDE 28MM	10 stuks
I 003191	KIT ROTOR KN SIDE 30MM	10 stuks
I 003192	KIT ROTOR KN SIDE 35MM	10 stuks
I 003193	KIT ROTOR KN SIDE 40MM	10 stuks
I 003194	KIT ROTOR KN SIDE 45MM	10 stuks
I 003195	KIT ROTOR KN SIDE 50MM	10 stuks
I 003262	KIT ROTOR KN SIDE 55MM	10 stuks
I 003203	KIT ROTOR KN SIDE 60MM	10 stuks
I 003204	KIT ROTOR KN SIDE 65MM	10 stuks
I 003263	KIT ROTOR KN SIDE 70MM	10 stuks
I 003205	KIT ROTOR KN SIDE 80MM	10 stuks

**F9 Onderdelen**

- Knop koppeling
- Clipsen
- Bestifting



I 003253	CSF KIT CLUTCH KEY SIDE 28MM	10 stuks
I 003254	CSF KIT CLUTCH KEY SIDE 33MM	10 stuks
I 003196	KIT CLUTCH KN KEY SIDE 30MM	10 stuks
I 003197	KIT CLUTCH KN KEY SIDE 35MM	10 stuks
I 003198	KIT CLUTCH KN KEY SIDE 40MM	10 stuks
I 003199	KIT CLUTCH KN KEY SIDE 45MM	10 stuks
I 003200	KIT CLUTCH KN KEY SIDE 50MM	10 stuks
I 003201	KIT CLUTCH KN KEY SIDE 55MM	10 stuks
I 003202	KIT CLUTCH KN KEY SIDE 60MM	10 stuks



I 0037001	TUSSENRING	250 stuks
-----------	------------	-----------



I 0037011	PLUG CLIP	250 stuks
-----------	-----------	-----------



I 0037121	PLUG CLIP KN	250 stuks
-----------	--------------	-----------



I 0032146	CSF PIN KIT D2.5X4.6MM STEP 0	1000 stuks
I 0032151	CSF PIN KIT D2.5X5.1MM STEP 1	1000 stuks
I 0032156	CSF PIN KIT D2.5X5.6MM STEP 2	1000 stuks
I 0032161	CSF PIN KIT D2.5X6,1MM STEP 3	1000 stuks
I 0032166	CSF PIN KIT D2.5X6,6MM STEP 4	1000 stuks
I 0032171	CSF PIN KIT D2.5X7,1MM STEP 5	1000 stuks
I 0332176	CSF PIN KIT D2.5X7,6MM STEP 6	1000 stuks
I 0032181	CSF PIN KIT D2.5X8,1MM STEP 7	1000 stuks
I 0032186	CSF PIN KIT D2.5X8,6MM STEP 8	1000 stuks



I 90045050VE	CSF ANTI-PICK PIN KIT 2.5X5.0MM	1000 stuks
--------------	---------------------------------	------------



I 90045056VE	CSF ANTI-PICK PIN KIT 2.5X5.0MM	1000 stuks
--------------	---------------------------------	------------

### F9 Onderdelen

- Bestifting
- Knoppen



I 0035136	PLUG CONE-SHAPED 2,8X3,6MM	1000 stuks
-----------	----------------------------	------------

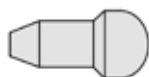

I 90046047VE CSF F90/F99/F900 CODING PIN LATERAL		1000 stuks
--	--	------------



I 0038135	KIT VEERTJE D2.5X13.5MM	1000 stuks
-----------	-------------------------	------------

I 044177	RONDE KNOP 30MM KOPER	1 stuk
----------	-----------------------	--------

I 044179	RONDE KNOP 30MM NIKKEL MET VINGERINLEG	1 stuk
----------	--	--------

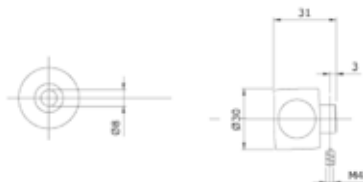

I 044167	PLATTE KNOP 35MM VLEUGEL KOPER	1 stuk
----------	--------------------------------	--------

I 044169	PLATTE KNOP 35MM VLEUGEL NIKKEL	1 stuk
----------	---------------------------------	--------

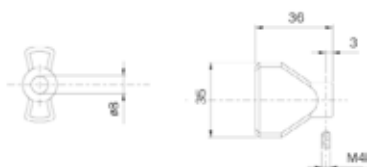

I 044149	DRIEHOEKIGE KNOP 40MM NIKKEL	1 stuk
----------	------------------------------	--------

I 044147	DRIEHOEKIGE KNOP 40MM KOPER	1 stuk
----------	-----------------------------	--------



I 044119	RONDE KNOP 30MM NIKKEL	1 stuk
----------	------------------------	--------

I 044117	RONDE KNOP 30MM KOPER	1 stuk
----------	-----------------------	--------



your world safely locked //®



**Dombrecht**  
DISTRIBUTION

Info@dombrecht.eu www.dombrecht.eu  
Tel: 052/44 74 84 Fax: 052/44 90 52

Versie v1.1.2

# Iseo R9Plus

Veiligheidscilinder

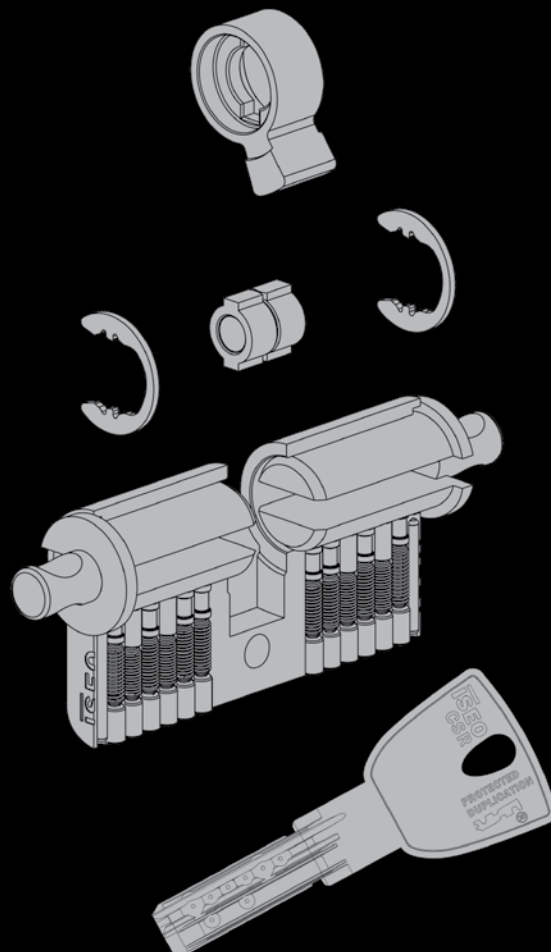

your world safely locked //®

Versie v1.1.2

Info@dombrecht.eu www.dombrecht.eu  
Tel: 052/44 74 84 Fax: 052/44 90 52



**Dombrecht**  
DISTRIBUTION

## R9 Onderdelen

- Bestifting
- Benodigdheden
- Gereedschappen

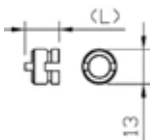

I 003045	BESTIFTINGSVALIES CSR-CSF	
I 003109	CSF/CSR MONTAGE-APPARAAT	
I 003111	DUWPLAATJE VOOR VEREN/STIFTEN	
I 003104	OPENINGSTANG VOOR CILINDER	
I 003105	SLUITTANG VOOR CILINDER	
I 003106	PINCET VOOR STIFTEN	
I 003007	HULPSTUK VOOR CILINDERMONTAGE	
I 003113	HULPSTUK AFLEZEN SLEUTELDIEPTE	
I 003281	KERNVERLENGING 10 MM	10 stuks
I 003282	KERNVERLENGING 15MM	10 stuks
I 003283	KERNVERLENGING 20MM	10 stuks
I 003284	KERNVERLENGING 25MM	10 stuks
I 003285	KERNVERLENGING 30MM	10 stuks
I 003211	KIT EXTENSION ROTOR 5MM	10 stuks
I 003212	KIT EXTENSION ROTOR 10MM	10 stuks
I 003213	KIT EXTENSION ROTOR 15MM	10 stuks
I 003214	KIT EXTENSION ROTOR 20MM	10 stuks
I 003215	KIT EXTENSION ROTOR 25MM	10 stuks
I 003216	KIT EXTENSION ROTOR 30MM	10 stuks
I 003217	KIT EXTENSION ROTOR 35MM	10 stuks
I 003218	KIT EXTENSION ROTOR 40MM	10 stuks

**R9 Onderdelen**

- Kernverlenging
- Sleutelverlenging
- Kit knop
- Meenemers



I 003191	KIT ROTOR KN SIDE 30MM	10 stuks
I 003192	KIT ROTOR KN SIDE 35MM	10 stuks
I 003193	KIT ROTOR KN SIDE 40MM	10 stuks
I 003194	KIT ROTOR KN SIDE 45MM	10 stuks
I 003195	KIT ROTOR KN SIDE 50MM	10 stuks
I 003262	KIT ROTOR KN SIDE 55MM	10 stuks
I 003203	KIT ROTOR KN SIDE 60MM	10 stuks
I 003204	KIT ROTOR KN SIDE 65MM	10 stuks
I 003205	KIT ROTOR KN SIDE 80MM	10 stuks



I 003258	KIT MEENEMER R9 CSR 28MM	10 stuks
I 003260	KIT MEENEMER R9 CSR 30MM	10 stuks



I 0033220	KIT CLUTCH GF 30-30	10 stuks
I 0033221	KIT CLUTCH GF 30-35	10 stuks
I 0033222	KIT CLUTCH GF 35-35	10 stuks



I 003187	KIT CLUTCH KN KEY SIDE 30MM	10 stuks
I 003188	KIT CLUTCH KN KEY SIDE 35MM	10 stuks



I 0032151	KIT CODESTIFTEN 2.5X5.1MM R9 STEP 0	1000 stuks
I 0032156	KIT CODESTIFTEN 2.5X5.6MM R9 STEP 1	1000 stuks
I 0032161	KIT CODESTIFTEN 2.5X6.1MM R9 STEP 2	1000 stuks
I 0032166	KIT CODESTIFTEN 2.5X6.6MM R9 STEP 3	1000 stuks
I 0032171	KIT CODESTIFTEN 2.5X7.1MM R9 STEP 4	1000 stuks
I 0032176	KIT CODESTIFTEN 2.5X7.6MM R9 STEP 5	1000 stuks

I 0034180	STIFTEN 2.5*5.6MM	
-----------	-------------------	--



I 0033160	R9 KIT VOLLE TEGENSTIFT 2.5X3.5MM	1000 stuks
-----------	-----------------------------------	------------



I 0034170	PADDESTOELSTIFT 2.5*5.0 R9 PL	1000 stuks
I 0034160	R9 KIT PADDESTOELSTIFT 2.5X3.5MM	1000 stuks

## R9 Onderdelen

- Bestifting

104



I 0039110	R9 KIT STIFTEN 2.5X1.0MM STEP 2	1000 stuks
I 0039115	R9 KIT STIFTEN 2.5X1.5MM STEP 3	1000 stuks
I 0039120	R9 KIT STIFTEN 2.5X2.0MM STEP 4	1000 stuks
I 0039125	R9 KIT STIFTEN 2.5X2.5MM STEP 5	1000 stuks



I 0035136	PLUG CONE-SHAPED 2,8X3,6MM	1000 stuks
-----------	----------------------------	------------



I 0038084	R9 KIT VEERTJE D2.5X8.3MM	1000 stuks
-----------	---------------------------	------------

I 0038200	R9 PLUS/R7 BAL D.2MM	1000 stuks
-----------	----------------------	------------



I 0039130	R9 KIT STIFTEN 2.5X3.0MM STEP 6	1000 stuks
-----------	---------------------------------	------------

I 0032158	R9 PLUS STIFT PASSIEF	1000 stuks
-----------	-----------------------	------------



I 0037001	TUSSENRING	250 stuks
-----------	------------	-----------



I 0037011	PLUG CLIP	250 stuks
-----------	-----------	-----------



I 0037021	STAAL CLIPS VOOR R5	250 stuks
-----------	---------------------	-----------

I 003132	KIT DIN CAM MEENEMER HALFCILINDER	10 stuks
----------	-----------------------------------	----------



I 003150	R9 KIT DIN CAM ITALIAANSE MEENEMER	100 stuks
----------	------------------------------------	-----------

I 0032134	SLUITSTIFT LATERAAL R9 1-2-4-6	1000 stuks
-----------	--------------------------------	------------

I 0032142	STIFTEN LATERAAL R9 PLUS 3-5	1000 stuks
-----------	------------------------------	------------

**R9 Onderdelen**

- Bestifting



I 044177	RONDE KNOP 30MM KOPER	1 stuk
I 044179	RONDE KNOP 30MM NIKKEL MET VINGERINLEG	1 stuk

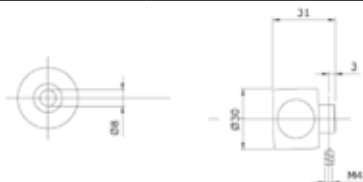

I 044167	PLATTE KNOP 35MM VLEUGEL KOPER	1 stuk
I 044169	PLATTE KNOP 35MM VLEUGEL NIKKEL	1 stuk

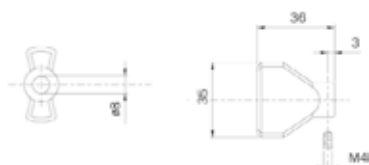

I 044149	DRIEHOEKIGE KNOP 40MM NIKKEL	1 stuk
I 044147	DRIEHOEKIGE KNOP 40MM KOPER	1 stuk



I 044119	RONDE KNOP 30MM NIKKEL	1 stuk
I 044117	RONDE KNOP 30MM KOPER	1 stuk



# Iseo LE60

Modulair Systeem

LE60-configuratie van CSR- en CSF-systemen maakt een snelle installatie mogelijk, onafhankelijk van de deurdikte en slotpositie. Modulair systeem maakt installatie ter plaatse veilig, zonder voorafgaande inspectie. U hoeft de vereiste cilinderafmetingen niet van tevoren te gaan opmeten.

LE60 maakt meer zakelijke kansen mogelijk zonder voorraadverhoging, vermindert het risico van langzaam bewegende dimensies en verbetert de klantenservice. Voorraadbeheer is eenvoudig dankzij de gemeenschappelijke componenten voor zowel mechanische als mechanische cilinders.

ISEO heeft een specifieke montagekoffer ontworpen met modulaire componenten en verbindingstaven in de meest gebruikte afmetingen. De montagekoffer kan naar keuze van de installateur worden aangevuld met componenten. Er is ook ruimte voor gereedschap om cilinders ter plaatse te monteren.



**LE60 Onderdelen**
**Modulaire cilinder**
**CSF F9**
**CSR R9+**

8MFA0K0029DD MODULE PAAR VOOR DUBBELCIL. F9 KD PROF. DD

8MFA0K0029.8DD MODULE PAAR VOOR DUBBELCIL. F9 KA PROF. DD

8MFA0K0029.8DDC MODULE PAAR VOOR DUBBELCIL. F9 KA MONTAGE DD OP CODE



8MRP0K0029DD MODULE PAAR VOOR DUBBELCIL. R9PLUS KD PROF. DD

8MRP0K0029.8DD MODULE PAAR VOOR DUBBELCIL. R9PLUS KA PROF. DD

8MRP0K0029.8DDC MODULE PAAR VOOR DUBBELCIL. R9PLUS KA MONTAGE DD OP CODE



8MFA0K0019DD MODULE VOOR ENKELE CIL. F9 KD PROF DD

8MFA0K0019.8DD MODULE VOOR ENKELE CIL. F9 KA PROFIEL DD

8MFA0K0019.8DDC MODULE VOOR ENKELE CIL. F9 KA MONTAGE DD OP CODE



8MRP0K0019DD MODULE VOOR ENKELE CIL. R9PLUS PROF. DD

8MRP0K0019.8DD MODULE VOOR ENKELE CIL. R9PLUS KA PROF. DD

8MRP0K0019.8DDC MODULE VOOR ENKELE CIL. R9PLUS KA MONTAGE DD OP CODE

8MFR000019S.W MODULE SS VERSIE

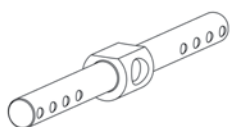

I 0033230 CONNECTIEBALK VR DUBBELCIL. 3030/3035/3535 5 stuks

I 0033240 CONNECTIEBALK VR DUBBELCIL. 3040/3045/3540/3545 5 stuks

I 0033250 CONNECTIEBALK VR DUBBELCIL. 4040/4045/4545 5 stuks

I 0033260 CONNECTIEBALK VR DUBBELCIL. 3050/3055/3550/3555 5 stuks

I 0033270 CONNECTIEBALK VR DUBBELCIL. 3060/3065/3560/3565 5 stuks

I 0033280 CONNECTIEBALK VR DUBBELCIL. 4050/4055/4550/4555 5 stuks

I 0033290 CONNECTIEBALK VR DUBBELCIL. 5050/5055/5555 5 stuks

I 0033300 CONNECTIEBALK VR DUBBELCIL. 3070/3075/3570/3575 5 stuks

I 0033310 CONNECTIEBALK VR DUBBELCIL. 4060/4065/4560/4565 5 stuks

I 0033320 CONNECTIEBALK VR DUBBELCIL. 3080/3085/3580/3585 5 stuks

I 0033330 CONNECTIEBALK VR DUBBELCIL. 4070/4075/4570/4575 5 stuks

I 0033340 CONNECTIEBALK VR DUBBELCIL. 5060/5065/5560/5565 5 stuks

I 0033350 CONNECTIEBALK VR DUBBELCIL. 6060/6065/6565 5 stuks

I 0033360 CONNECTIEBALK VR DUBBELCIL. 3090/3095/3590/3595 5 stuks

I 0033370 CONNECTIEBALK VR DUBBELCIL. 4080/4085/4580/4585 5 stuks

I 0033380 CONNECTIEBALK VR DUBBELCIL. 5070/5075/5570/5575 5 stuks

I 0033390 CONNECTIEBALK VR DUBBELCIL. 4090/4095/4590/4595 5 stuks

I 0033400 CONNECTIEBALK VR DUBBELCIL. 5080/5085/5580/5585 5 stuks

I 0033410 CONNECTIEBALK VR DUBBELCIL. 6070/6075/6570/6575 5 stuks

**LE60 Onderdelen**  
**Modulaire cilinder**  
**CSF F9**  
**CSR R9+**



I 0033450	CONNECTIEBALK VR HALFCIL. 3010/3510	5 stuks
I 0033460	CONNECTIEBALK VR HALFCIL. 4010/4510	5 stuks
I 0033470	CONNECTIEBALK VR HALFCIL. 5010/5510	5 stuks
I 0033480	CONNECTIEBALK VR HALFCIL. 6010/6510	5 stuks
I 0033490	CONNECTIEBALK VR HALFCIL. 7010/7510	5 stuks
I 0033500	CONNECTIEBALK VR HALFCIL. 8010/8510	5 stuks
I 0033510	CONNECTIEBALK VR HALFCIL. 9010/9510	5 stuks



I 0033520	UNIVERSELE CONNECTIEBALK HARDSTAAL 60/90	2 stuks
I 0033552	UNIVERSELE CONNECTIEBALK HARDSTAAL 80/180	2 stuks
I 0033553	UNIVERSELE CONNECTIEBALK HARDSTAAL 130/130	2 stuks

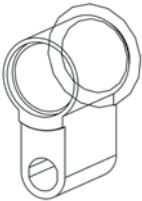

I 0033530	JOLLY CONNECTIEBALK HARDSTAAL 90/10 VR HALFCIL	2 stuks
-----------	--	---------



I 0033570	VERLENGING VR CIL. BODY 5 MM	5 stuks
I 0033580	VERLENGING VR CIL. BODY 10 MM	5 stuks
I 0033590	VERLENGING VR CIL. BODY 15 MM	5 stuks
I 0033600	VERLENGING VR CIL. BODY 20 MM	5 stuks
I 0033610	VERLENGING VR CIL. BODY 40 MM	5 stuks



I 0033620	KIT ROTOR VERLENGING DUBBEL CIL. 35MM ZIJDE	5 stuks
-----------	---	---------



I 0033630	ROTOR VERLENGINGSKIT VR GEVARENFUNCTIE 35 MM	5 stuks
-----------	--	---------



I 0033640	ROTOR VERLENGINGSKIT VR KNOP CIL. 35 MM SL.ZIJDE	5 stuks
-----------	--	---------



I 0033650	ROTOR VERLENGINGSKIT VR KNOP CIL. 35 MM KNOPZIJDE	5 stuks
-----------	---	---------



**LE60 Onderdelen**  
**Modulaire cilinder**  
**CSF F9**  
**CSR R9+**



I 0033660	ROTOR VERLENGINGSKIT VR HALFCIL. 35MM	5 stuks
-----------	---------------------------------------	---------



I 0033670	ROTOR VERLENGING 10 MM	5 stuks
I 0033680	ROTOR VERLENGING 15 MM	5 stuks
I 0033690	ROTOR VERLENGING 20 MM	5 stuks
I 0033700	ROTOR VERLENGING 40MM	5 stuks

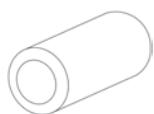

I 003211	SLEUTELVERLENGING 8*5 MM	10 stuks
I 003212	SLEUTELVERLENGING 8*10 MM	10 stuks
I 003213	SLEUTELVERLENGING 8*15 MM	10 stuks
I 003214	SLEUTELVERLENGING 8*20 MM	10 stuks
I 003215	SLEUTELVERLENGING 8*25 MM	10 stuks
I 003216	SLEUTELVERLENGING 8*30 MM	10 stuks
I 003217	SLEUTELVERLENGING 8*35 MM	10 stuks
I 003218	SLEUTELVERLENGING 8*40 MM	10 stuks



I 0033880	KIT 2 ST. MODULE VR KNOPCIL. NIKKEL	
-----------	-------------------------------------	--



I 0033720	SLUITRING	250 stuks
-----------	-----------	-----------



I 0033740	SLUITPINNETJES STAAL	100 stuks
-----------	----------------------	-----------



I 0033750	CONNECTIERING	100 stuks
-----------	---------------	-----------



I 0033920	VERLENGINGSPIN VR HALFCIL. SERIE F EN R L>=40 mm	50 stuks
-----------	--	----------

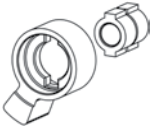

I 003260	KIT MEENEMER R9 CSR 30MM	10 stuks
----------	--------------------------	----------

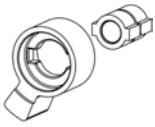

I 003296	KIT MEENEMER VR F SERIE	10 stuks
----------	-------------------------	----------



I 003132	KIT DIN CAM MEENEMER VR HALF CIL.	10 stuks
----------	-----------------------------------	----------



I 003267	KOPPELING VR KNOPCIL F/R SERIE SL. ZIJDE 30 MM	10 stuks
----------	--	----------



I 003269	KOPPELING VR KNOPCIL F/R SERIE SL. ZIJDE 35 MM	10 stuks
----------	--	----------



I 003298	MEENEMER VOOR KNOPCIL. SERIE F	10 stuks
----------	--------------------------------	----------



I 003184	MEENEMER VR. KNOPCIL. F/R SERIE SL. ZIJDE 35 MM	10 stuks
----------	---	----------



**LE60 Onderdelen**  
**Modulaire cilinder**  
**CSF F9**  
**CSR R9+**

	I 0033210	KIT MEENEMER VR CIL. GEVARENFUNCTIE SERIE F 30/30	10 stuks
	I 0033211	KIT MEENEMER VR CIL. GEVARENFUNCTIE SERIE F 30/35	10 stuks
	I 0033212	KIT MEENEMER VR CIL. GEVARENFUNCTIE SERIE F 35/35	10 stuks
	I 0033220	KIT MEENEMER VR CIL. GEVARENFUNCTIE SERIE R 30/30	10 stuks
	I 0033221	KIT MEENEMER VR CIL. GEVARENFUNCTIE SERIE R 30/35	10 stuks
	I 0033222	KIT MEENEMER VR CIL. GEVARENFUNCTIE SERIE R 35/35	10 stuks
	I 0033092	CILINDERHOUDER BLOKJE VOOR MODULAIRE CIL.	
	I 0033094	SLUITTANG VOOR SLUITPINNEN MODULAIRE CIL.	
	I 0033201	MONTAGE VALIES MODULAIRE CIL.	

## Hoofding

datum : de datum van ingave van het plan

projectnaam : naam van de bouw of referentie van het project

cilinderserie : type van cilinder invullen : bv. F9

systeem : type van systeem invullen : bv. MK/CK

## Rijen

positie : opeenvolgende nummering

markering/code : de code die op de sleutels en de cilinders zal gemarkeerd worden ( "change" )

omschrijving deur : beschrijving van de deur of het lokaal waarin de deur zich bevindt

artikelnummer : het correcte Iseo artikelnummer

spec. : specificaties : - indien knopcilinder : KN

- indien cilinder met gevarenfunctie : GF

- indien brievenbuscilinder : BB

lengte : lengte van de cilinder, bestaat uit 2 delen , altijd gemeten van het midden van het vijsgat.

Op het invulblad wordt de eerste maat, zonder spaties, gescheiden met een koppelteken van de tweede maat

Indien knopcilinder wordt de knopkant altijd in de kolom C geplaatst

Cil. : aantal cilinders op de betreffende code ('change')

sl. : aantal sleutels nodig voor die lijn

## Kolommen

Er zijn 2 grote rubrieken :

1) linkerdeel : hoofdsleutelstructuur

2) rechterdeel : structuur voor de centrale deuren

1) hoofdsleutelstructuur

code : dit is de code die op de hoofdsleutel zal gemarkeerd worden

omschrijving : omschrijving van de hoofdsleutel

aantal : aantal hoofdsleutels

U duidt met kruisjes aan, welke cilinders de hoofdsleutels moeten openen

2) structuur voor de centrale deuren

code : dit is de code van de cilinders die als centrale deur worden beschouwd

omschrijving : beschrijving van de centrale deur

U duidt aan welke individuele sleutels welke centrale deuren mogen openen

Sleutels met functie 'I' openen cilinders met functie 'E'

## PROCEDURE

Diegene die het plan opmaakt vult het excel blad volledig in, voor zover het geen eenvoudig plan betreft. De definitieve versie wordt bezorgd aan de sluitplan afdeling van Dombrecht Distribution . De klant krijgt een PDF versie van het sleutelplan uit de lockbase software. Dit plan moet goedgekeurd worden door diegene die het plan bestelt.

Vanaf de goedkeuring begint de leveringstermijn te lopen !

Vanaf de goedkeuring is de lockbase PDF versie van het plan , de enige versie waarmee gecommuniceerd wordt. ( uitbreidingen, herbestellingen )

ONTWERP SLEUTELPLAN PROJET ORGANIGRAMME										HOOFDSLEUTELS / CLEFS PASSE-PARTOUT			CENTRALE DEUREN/PORTES CENTRALES		
Datum / Date: Projectnaam/nom du projet: Cilinderserie / Série de cylindre: Systeem / Système:										Aantal			Description		
Pos.	markering/code marquage/code	Omschrijving deur Description porte	Artikelnummer N° d'article	Spec.	Lengte/Longueur		Aantal/nombre		Code	Omschrijving / Description	Code	Omschrijving / Description			
					C	D	Cil/Cyl	Sil/Cl					Code	Omschrijving / Description	
1	A01	centrale deur app porte centr.	82FA030609M		30-60		2	6		x	x				
2	A01	centrale deur app porte centr.	82FA035459M		35-45		1	0		x	x				
3	A1	app. 1 voordeur/porte entrée	82FA930409M	GF/FD	30-40		1	3		x					
4	A1	app. 1 berging/débarras	82FA830309M	KN/BOUT	30-30		1	0		x					
5	A2	app. 2 voordeur/porte entrée	82FA930409M	GF/FD	30-40		1	3		x					
6	A2	app. 2 berging/débarras	82FA830309M	KN/BOUT	30-30		1	0		x					
7	A3	app. 3 voordeur/porte entrée	82FA930409M	GF/FD	30-40		1	3		x					
8	A3	app. 3 berging/débarras	82FA830309M	KN/BOUT	30-30		1	0		x					
9	A4	app. 4 voordeur/porte entrée	82FA930409M	GF/FD	30-40		1	3		x					
10	A4	app. 4 berging/débarras	82FA830309M	KN/BOUT	30-30		1	0		x					
11	A5	app. 5 voordeur/porte entrée	82FA930409M	GF/FD	30-40		1	3		x					
12	A5	app. 5 berging/débarras	82FA830309M	KN/BOUT	30-30		1	0		x					
13	A6	app. 6 voordeur/porte entrée	82FA930409M	GF/FD	30-40		1	3		x					
14	A6	app. 6 berging/débarras	82FA840309M	KN/BOUT	40-30		1	0		x					
15	B01	deur winkels/porte magasins	82FA030609M		30-60		1	3		x	x	x			
16	B1	winkel 1/magasin 1	82FA035509M		35-50		1	3		x	x				
17	B2	winkel 2/magasin 2	82FA035509M		35-50		1	3		x	x				
18	B3	winkel 3/magasin 3	82FA035509M		35-50		1	3		x	x				
19	B4	winkel 4/magasin 4	82FA035509M		35-50		1	3		x	x				
20	B5	winkel 5/magasin 5	82FA035509M		35-50		1	3		x	x				
21	C01	deur- serviceflats-porte	82FA030609M		30-60		1	3		x	x				
22	C1	flat 1	82FA030309M		30-30		1	3		x					
23	C2	flat 2	82FA030309M		30-30		1	3		x					
24	C3	flat 3	82FA030309M		30-30		1	3		x					
25	C4	flat 4	82FA030309M		30-30		1	3		x					
26	C5	flat 5	82FA030309M		30-30		1	3		x					
Totaal aantal cilinders / eigen sleutels :							18	33							



# Enkelpunt sloten



your world safely locked //®

Versie v1.1.2



**Dombrecht**  
DISTRIBUTION



## Sloten 72mm

# 118

### 118. Dyla 112

Binnendeurslot met baardsleutel

### 119. Dyla 1067

Binnendeurslot met ronde schoten en baardsleutel

### 120. Dyla 114

Insteekcilinderslot

### 121. Dyla 604

Insteekcilinderslot

### 123. BHM B300

Projectslot Klasse 3

### 125. BHM B300

Toiletslot

### 126. BHM B450

Projectslot klasse 4

### 127. Wilka WI5495

Zelfvergrendelend paniekslot

## Sloten 85mm

# 128

### 128. Iseo I 291105402

Insteekcilinder slot

### 129. Iseo Electa

Smaldeurslot met valschoot

### 130. Iseo I 741N203

Smaldeurslot nachtschoot

## Sloten 92mm

# 131

### 131. Iseo Performa

1-punt cilinderslot

### 132. Iseo Blindo

Veiligheidsvalslot

### 133. Wilka WI 1433

Veiligheidssmaldeurslot

### 134. Wilka WI 1438

Veiligheids smalslot

### 134. Wilka WI 1438 - lange voorplaat

Veiligheids smalslot

### 135. BMH B 34PZW

Insteekcilinderslot

### 137. Wilka WI 1435

Veiligheidsvalslot

### 138. Wilka WI 7667

Zelfvergrendelend paniekslot

### 139. Wilka WI 1436

Veiligheidshaakslot

## Sloten 110mm

# 140

### 140. Dyla 100

Insteekslot met baardsleutel

### 141. Dyla 102

Insteekslot

### 142. Dyla 1022

Insteekslot met baardsleutel ronde schoten

### 143. Dyla 1601

Veiligheidscilinderslot

### 144. Dyla 159

Insteekslot lange voorplaat

### 145. Dyla 601

Insteekslot profielcilinder

## Bijzetsloten

# 146

### 146. Fiam 14011050

Penslot

### 147. BMH b 114

Nacht bijzetslot

117

your world safely locked //®



# Dyla 112

Binnendeurslot met baardsleutel

118

## Binnendeurslot met baardsleutel

Asafstand: 72mm  
 Breedte voorplaat: 22mm  
 Type voorplaat: Afgerond/Hoekig  
 Materiaal voorplaat: Gelakt  
 Type Sluitplaat: Dag/Nacht  
 Draairichting: Keerbaar  
 Kruknoot: 8mm  
 Sluiting: 2-toers  
 Sluitlengte: 20mm  
 Type sleutel: Baardsleutel  
 Lengte voorplaat: 235mm

Andere eigenschappen:  
 Geleverd met 1 vernikkelde sleutel  
 Inclusief sluitplaat  
 Messingvoorplaat op bestelling

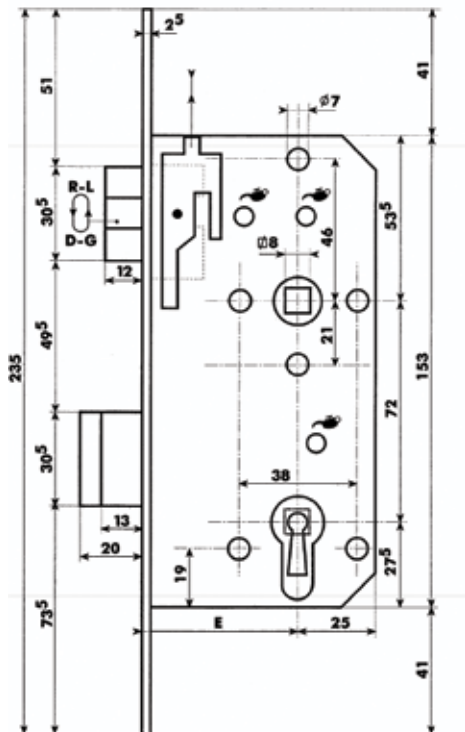

### Rechthoekige voorplaat

50mm	DY 112/H/50
55mm	DY 112/H/55
	DY 112/H/55/OPDEK/L
	DY 112/H/55/OPDEK/R
60mm	DY 112/H/60
	DY 112/H/60/OPDEK/L
	DY 112/H/60/OPDEK/R
65mm	DY 112/H/65
	DY 112/H/65/OPDEK/R

### Afgeronde voorplaat

50mm	DY 112/O/50
55mm	DY 112/O/55
60mm	DY 112/O/60

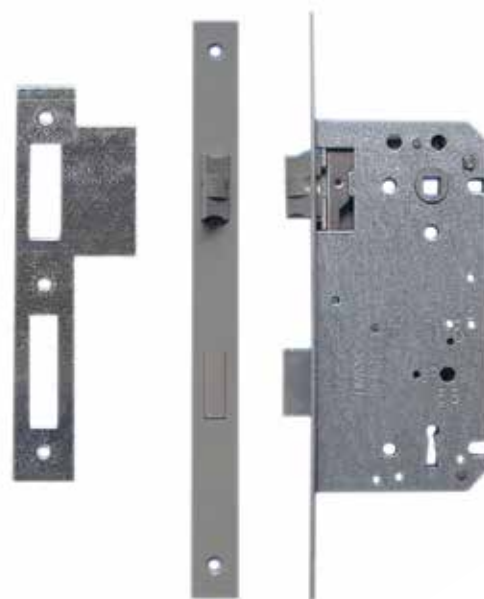

your world safely locked //®

# Dyla 1067

Binnendeurslot met baardsleutel en ronde schoten

## Binnendeurslot met baardsleutel en ronde schoten

Asafstand: 72mm  
 Breedte voorplaat: 22mm  
 Type voorplaat: Afgerond/Hoekig  
 Materiaal voorplaat: Gelakt  
 Type sleutplaat: Dag/Nacht  
 Draairichting: Keerbaar  
 Kruknoot: 8mm  
 Sluiting: 1 toer  
 Sluitlengte: 13mm  
 Type sleutel: Baarsleutel  
 Lengte voorplaat: 235mm

Andere eigenschappen:  
 Met ronde dag/nacht schoten  
 Geleverd met 1 vernikkelde sleutel  
 Inclusief sluitplaat  
 Messingvoorplaat op bestelling

Rechthoekige voorplaat	
50mm	DY 1067/50/H
55mm	DY 1067/55/H
60mm	DY 1067/60/H

Afgeronde voorplaat	
50mm	DY 1067/50/O
55mm	DY 1067/55/O

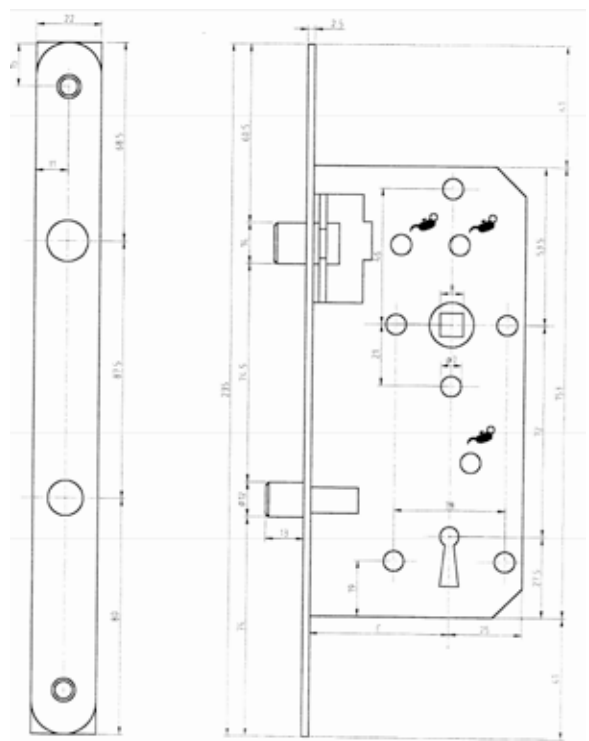

# Dyla 114

Insteekcilinder slot

120

## Insteekcilinder slot

Asafstand: 72mm  
 Breedte voorplaat: 22mm  
 Type voorplaat: Afgerond/Hoekig  
 Materiaal voorplaat: Gelakt  
 Type sluiting: Dag/Nacht  
 Draairichting: Keerbaar  
 Kruknoot: 8mm  
 Sluiting: 2-toers  
 Sluitlengte: 20mm  
 Type sleutel: Cilinderslot  
 Lengte voorplaat: 235mm

Andere eigenschappen:  
 Met patentgaten  
 Inclusief sluitplaat

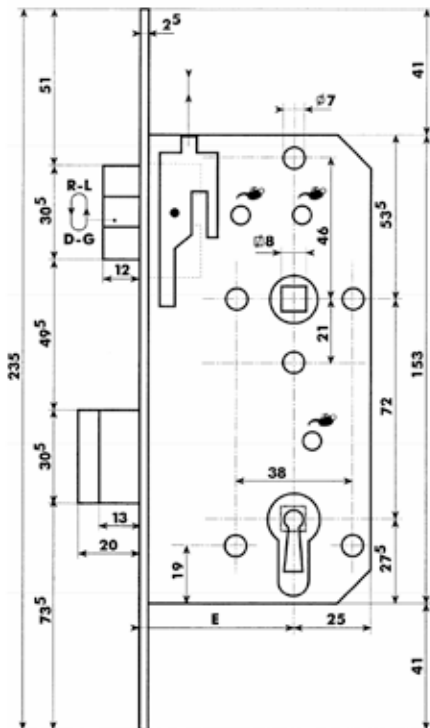

### Rechthoekige voorplaat

50mm	DY 114/H/50
	DY 114/H/50/OPDEK/L
55mm	DY 114/H/55
	DY 114/H/55/OPDEK/L
	DY 114/H/55/OPDEK/R
60mm	DY 114/H/60
	DY 114/H/65

### Afgeronde voorplaat

50mm	DY 114/O/50
55mm	DY 114/O/55
60mm	DY 114/O/60
65mm	DY 114/O/65



# BMH 300BB

Projectslot met Baardsleutel klasse 3

122

## Projectslot Klasse 3

Asafstand: 72mm  
 Breedte voorplaat: 20 en 24mm  
 Type voorplaat: Afgerond/Hoekig  
 Materiaal voorplaat: Inox  
 Type sluiting: Dag/Nacht  
 Draairichting: Niet keerbaar  
 Kruknoot: 8mm  
 Sluiting: 2-toers  
 Sluitlengte: 22mm  
 Type sleutel: Baardsleutel  
 Lengte voorplaat: 235mm

Andere eigenschappen:  
 Din klasse 3  
 Schoten in metaal vernikkeld  
 Kruknoot in metaal met vederklem  
 Gesloten slotkast  
 Geleverd met 1 sleutel

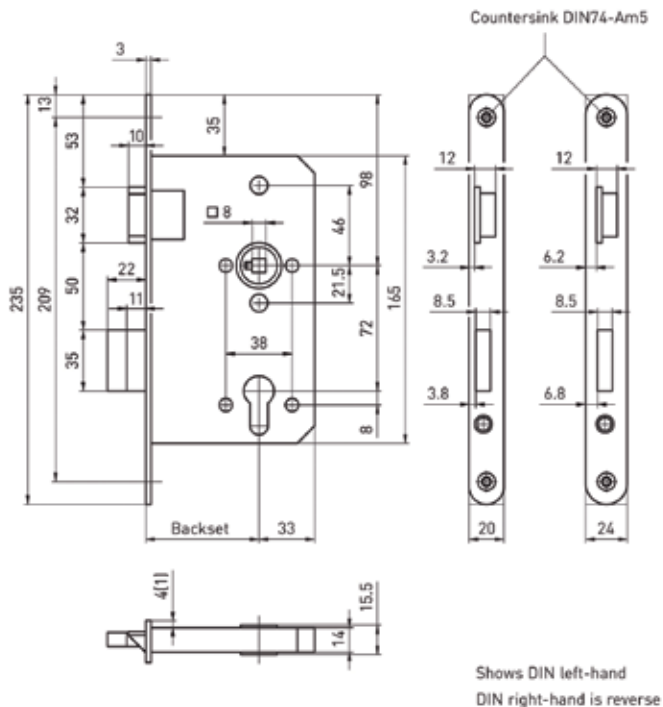

Afgeronde voorplaat 20mm		
55mm	Din L	B 300BB/55/20/ONDL
60mm	Din L	B 300BB/60/20/ONDL
	Din R	B 300BB/60/20/ONDR

Afgeronde voorplaat 24mm		
55mm	Din L	B 300BB/55/24/ONDL
	Din R	B 300BB/55/24/ONDR
60mm	Din L	B 300BB/60/24/ONDL
	Din R	B 300BB/60/24ONDR



# BMH 300

Projectslot klasse 3

## Projectslot Klasse 3

Asafstand: 72mm  
 Breedte voorplaat: 20mm  
 Type voorplaat: Afgerond/Hoekig  
 Materiaal voorplaat: Inox  
 Type sluiting: Dag/Nacht  
 Draairichting: Niet keerbaar  
 Kruknoot: 8mm  
 Sluiting: 2-toers  
 Sluitlengte: 22mm  
 Type sleutel: Cilinderslot  
 Lengte voorplaat: 235mm

Andere eigenschappen:  
 Project cilinderslot  
 Din klasse 3  
 Schoten in metaal vernikkeld  
 Kruknoot in metaal met vederklem  
 Gesloten slotkast

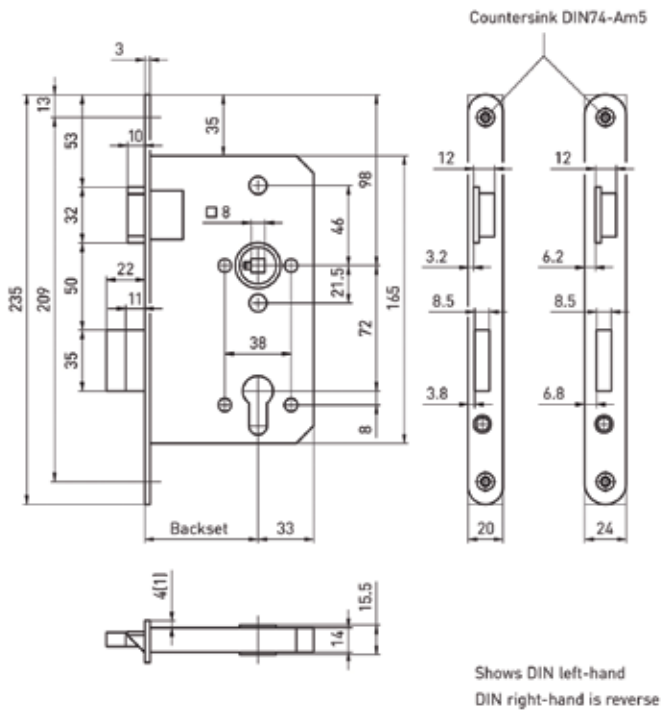

### Rechthoekige voorplaat 20mm

50mm	Din L	B 300PZW/50/20/KNDL
	Din R	B 300PZW/50/20/KNDR
55mm	Din L	B 300PZW/55/20/KNDL
	Din R	B 300PZW/55/20/KNDR
60mm	Din L	B 300PZW/60/20/KNDL
	Din R	B 300PZW/60/20/KNDR

### Afgeronde voorplaat 20mm

50mm	Din R	B 300PZW/50/20/ONDR
55mm	Din L	B 300PZW/55/20/ONDL
	Din R	B 300PZW/55/20/ONDR
60mm	Din L	B 300PZW/60/20/ONDL
	Din R	B 300PZW/60/20/ONDR
80mm	Din L	B 300PZW/80/20/ONDL

# BMH 300

Projectslot klasse 3

124

## Projectslot Klasse 3

Asafstand: 72mm  
 Breedte voorplaat: 24mm  
 Type voorplaat: Afgerond/Hoekig  
 Materiaal voorplaat: Inox  
 Type sluiting: Dag/Nacht  
 Draairichting: Niet keerbaar  
 Kruknoot: 8mm  
 Sluiting: 2-toers  
 Sluitlengte: 22mm  
 Type sleutel: Cilinderslot  
 Lengte voorplaat: 235mm

Andere eigenschappen:  
 Project cilinderslot  
 Din klasse 3  
 Schoten in metaal vernikkeld  
 Kruknoot in metaal met vederklem  
 Gesloten slotkast

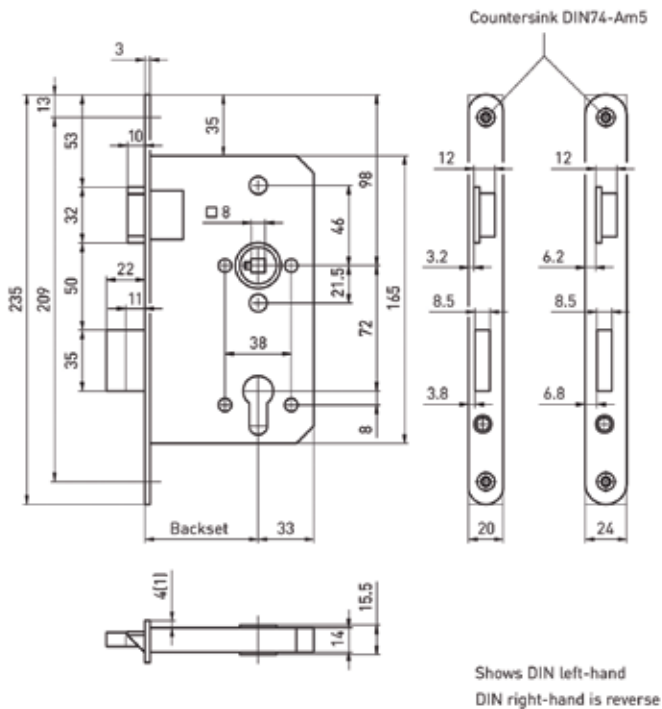

### Rechthoekige voorplaat 24mm

50mm	Din L	B 300PZW/50/24/KNDL
	Din R	B 300PZW/50/24/KNDR
55mm	Din L	B 300PZW/55/24/KNDL
	Din R	B 300PZW/55/24/KNDR
60mm	Din L	B 300PZW/60/24/KNDL
	Din R	B 300PZW/60/24/KNDR
65mm	Din L	B 300PZW/65/24/KNDL
	Din R	B 300PZW/65/24/KNDR
70mm	Din L	B 300PZW/70/24/KNDL
	Din R	B 300PZW/70/24/KNDR
80mm	Din L	B 300PZW/80/24/KNDL
		B 300PZW/80/24/KNDR

### Afgeronde voorplaat 24mm

50mm	Din L	B 300PZW/50/24/ONDL
	Din R	B 300PZW/50/24/ONDR
55mm	Din L	B 300PZW/55/24/ONDL
	Din R	B 300PZW/55/24/ONDR
60mm	Din L	B 300PZW/60/24/ONDL
	Din R	B 300PZW/60/24/ONDR
65mm	Din L	B 300PZW/65/24/ONDL
	Din R	B 300PZW/65/24/ONDR
80mm	Din L	B 300PZW/80/24/ONDL

# BMH 300

Projectslot Toiletslot klasse 3

## Projectslot Klasse 3

Asafstand: 78mm  
 Breedte voorplaat: 20 en 24mm  
 Type voorplaat: Afgerond/Hoekig  
 Materiaal voorplaat: Inox  
 Type sluiting: Dag/Nacht  
 Draairichting: Niet keerbaar  
 Kruknoop: 8mm  
 Sluiting: 2-toers  
 Sluitlengte: 22mm  
 Lengte voorplaat: 235mm

Andere eigenschappen:  
 Project toiletslot  
 Din klasse 3  
 Schoten in metaal vernikkeld  
 Kruknoop in metaal met vederklem  
 Gesloten slotkast

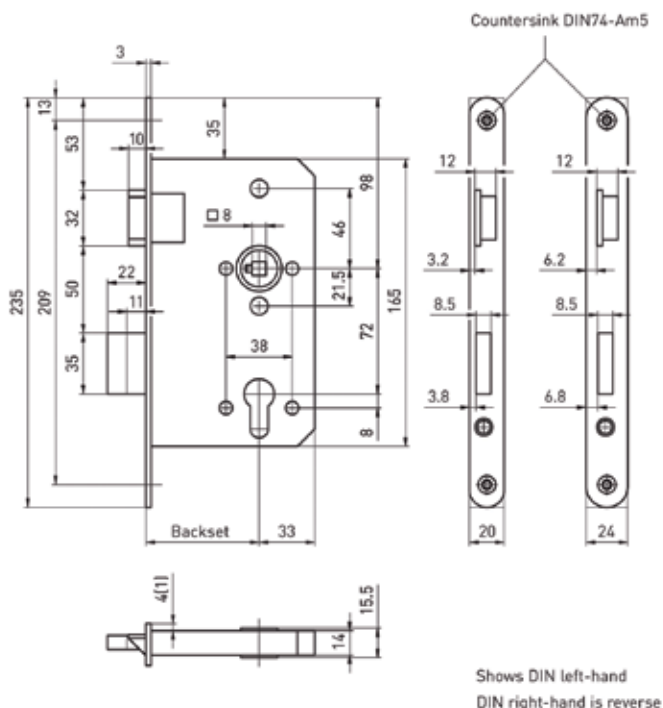

### Hoekige voorplaat 20mm

60mm	Din L	B 300BAD/60/20/KNDL
	Din R	B 300BAD/60/20/KNDR
65mm	Din R	B 300BAD/65/20/KNDR

### Hoekige voorplaat 24mm

55mm	Din L	B 300BAD/55/24/KNDL
	Din R	B 300BAD/55/24/KNDR
60mm	Din L	B 300BAD/60/24/KNDL
	Din R	B 300BAD/60/24/KNDR

### Afgeronde voorplaat 20mm

55mm	Din R	B 300BAD/55/20/ONDR
60mm	Din L	B 300BAD/60/20/ONDL
	Din R	B 300BAD/60/20/ONDR

### Afgeronde voorplaat 24mm

55mm	Din L	B 300BAD/55/24/ONDL
	Din R	B 300BAD/55/24/ONDR
60mm	Din L	B 300BAD/60/24/ONDL
	Din R	B 300BAD/60/24/ONDR



your world safely locked //®

# BMH 450

Projectslot klasse 4

126

## Projectslot Klasse 4

Asafstand: 72mm  
 Breedte voorplaat: 20 en 24mm  
 Type voorplaat: Afgerond/Hoekig  
 Materiaal voorplaat: Inox  
 Type sluiting: Dag/Nacht  
 Draairichting: Niet keerbaar  
 Kruknoot: 8mm  
 Sluiting: 2-toers  
 Sluitlengte: 22mm  
 Type sleutel: Cilinderslot  
 Lengte voorplaat: 235mm

Andere eigenschappen:  
 Project cilinderslot  
 Din klasse 3  
 Schoten in staal vernikkeld  
 Kruknoot in metaal met vederklem  
 Gesloten slotkast

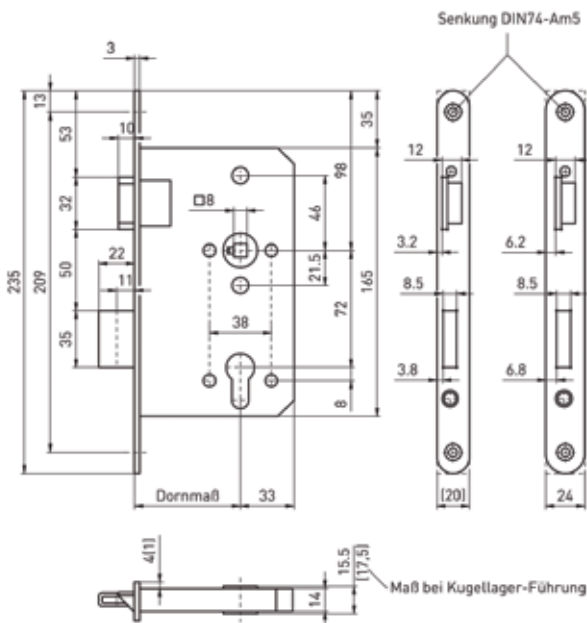

### Rechthoekige voorplaat 20mm

55mm	B 450PZW/55/20/KNDL
	B 450PZW/55/20/KNDR
60mm	B 450PZW/60/20/KNDL
	B 450PZW/60/20/KNDR

### Rechthoekige voorplaat 24mm

55mm	B 450PZW/55/24/KNDL
	B 450PZW/55/24/KNDR
60mm	B 450PZW/60/24/KNDL
	B 450PZW/60/24/KNDR
65mm	B 450PZW/65/24/KNDL
	B 450PZW/65/24/KNDR
70mm	B 450PZW/70/24/KNDL
80mm	B 450PZW/80/24/KNDL
	B 450PZW/80/24/KNDR

### Afgeronde voorplaat

55mm	B 450PZW/55/24/ONDL
	B 450PZW/55/24/ONDR
60mm	B 450PZW/60/24/ONDL
	B 450PZW/60/24/ONDR
90mm	B 450PZW/90/24/ONDL



# Wilka 5495

Zelfvergrendelend paniekslot

## Zelfvergrendeld paniekslot

Asafstand: 72mm  
 Breedte voorplaat: 24mm  
 Type voorplaat: Hoekig  
 Materiaal voorplaat: Inox  
 Type sluiting: Dag/Nacht  
 Draairichting: Niet keerbaar  
 Kruknoot: 8mm in 2 ringen gelagerd  
 Sluiting: 1 toer  
 Sluitlengte: 20mm  
 Type sleutel: Cilinderslot  
 Lengte voorplaat: 245mm

Andere eigenschappen:  
 Zelfvergrendelend  
 Paniekfunctie  
 Schoten vernikkeld gepolierd  
 Kan niet gebruikt worden ism elektrische deurpenner  
 Geschroefde gesloten slotkast  
 Voorzien van patentgaten

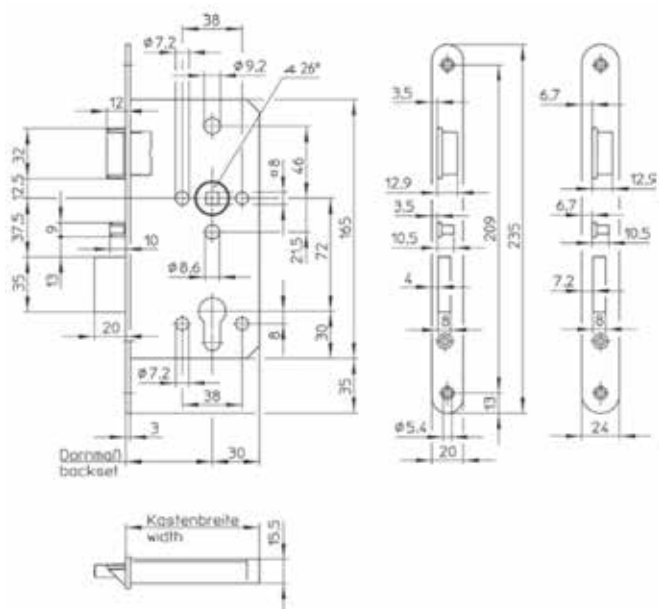

### Rechthoekige voorplaat

55mm	WI 5495/55/K/24/DL
	WI 5495/55/K/24/DR
60mm	WI 5495/60/K/24/DL
	WI 5495/60/K/24/DR
65mm	WI 5495/65/K/24/DL
	WI 5495/65/K/24/DR
80mm	WI 5495/80/K/24/DL
	WI 5495/80/K/24/DR

### Afgeronde voorplaat

55mm	WI 5495/55/O/24/DR
	WI 5495/55/O/24/DL

### Sluitplaat

WI 9171000002	Hoekig Din R
WI 9170000002	Hoekig Din L
WI 9169000002	Afgerond Din R
WI 9166000002	Afgerond Din L

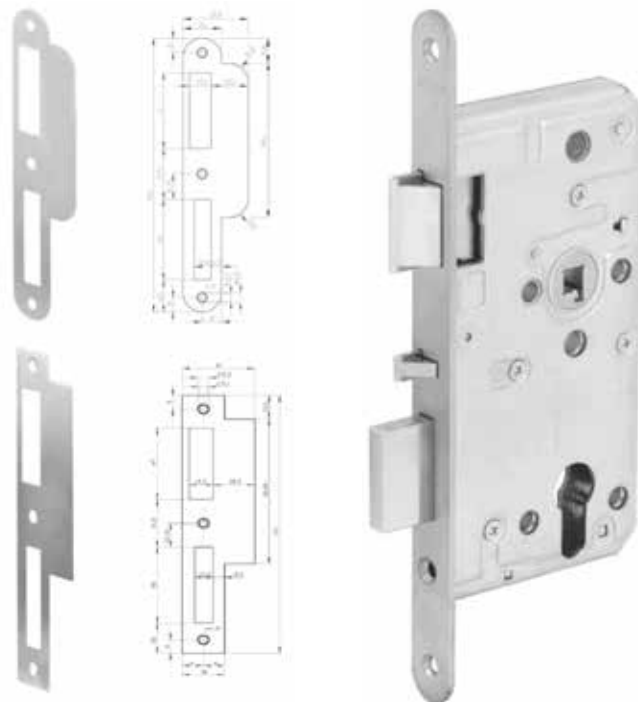

# Iseo 85sloten

Slot op 85mm

128

## Insteekslot op 85mm

Asafstand: 85mm  
 Breedte voorplaat: 22mm  
 Type voorplaat: Hoekig  
 Materiaal voorplaat: Inox  
 Type sluiting: Dag/Nacht  
 Draairichting: Keerbaar  
 Kruknoot: 8mm  
 Sluiting: 2-toers  
 Sluitlengte: 20mm  
 Type sleutel: Cilinderslot  
 Lengte voorplaat: 238mm

Andere eigenschappen:  
 Schoten in inox  
 Inclusief sluitplaat  
 Voorzien van patentgaten

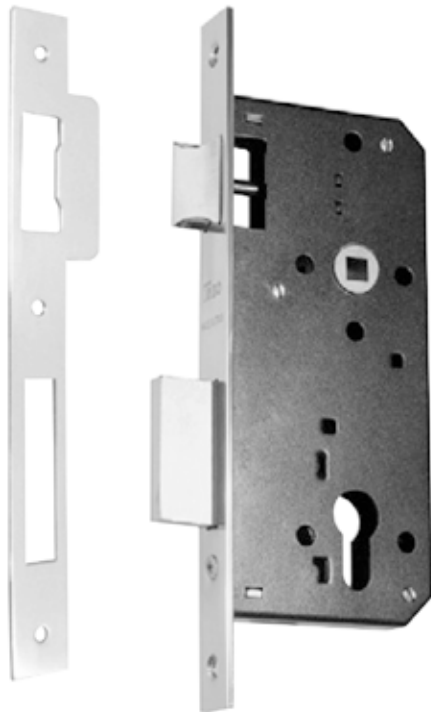

### Rechthoekige voorplaat

40mm	I 291105402
45mm	I 291105452
50mm	I 291105502
60mm	I 291105602
70mm	I 291105702

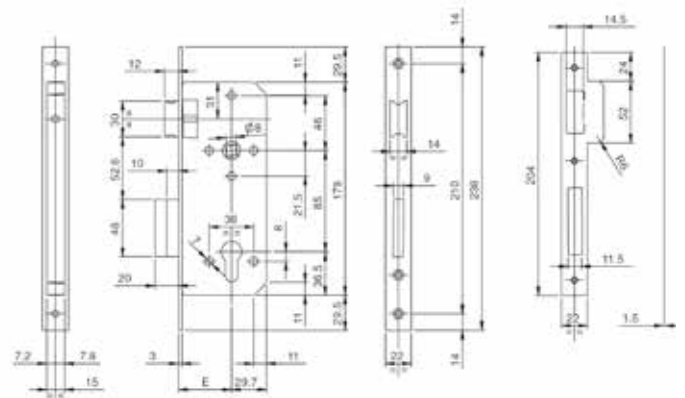

# Iseo Electa

Smaldeurslot met valschoot

## Smaldeurslot met Valschoot

- Asafstand: 85mm
- Breedte voorplaat: 24mm
- Type voorplaat: Hoekig
- Materiaal voorplaat: Inox
- Type sleutling: Dag/Nacht valschoot
- Draairichting: Keerbaar
- Kruknoot: 8mm
- Sluiting: 1 toer
- Sluitlengte: 24mm
- Type sleutel: Cilinderslot
- Lengte voorplaat: 290mm

Met rolnok enkel per 10 te bestellen

Rechthoekige voorplaat	
25mm	I 781251B
30mm	I 781301B
35mm	I 781351B

Rechthoekige voorplaat Rolnok	
25mm	I 781252B
30mm	I 781302B
35mm	I 781352B

Sluitplaat	
	I 038030

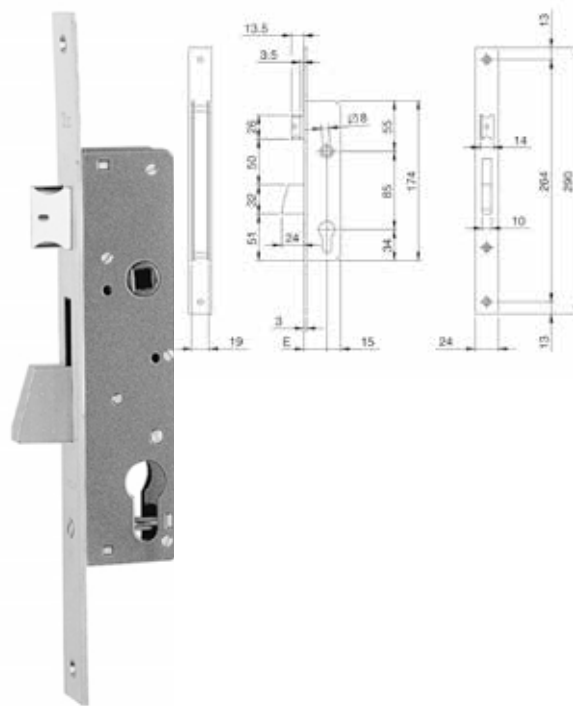
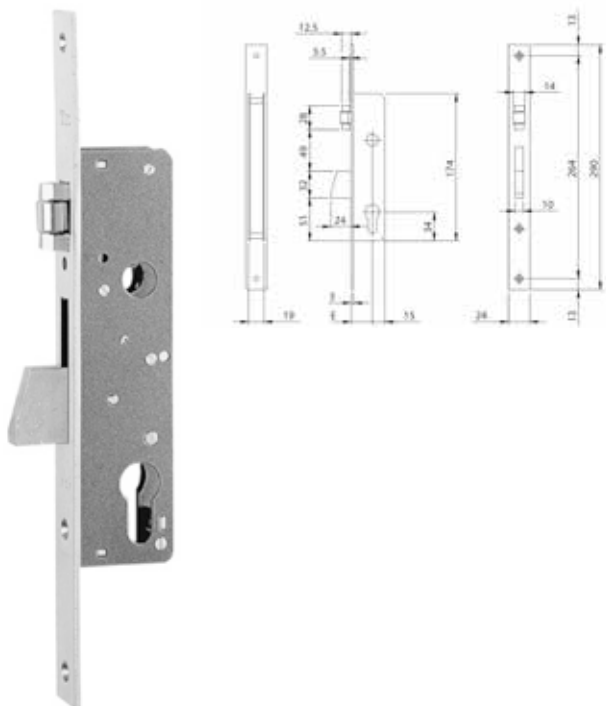

# Iseo 741N

Smaldeurslot

130

## Smaldeurslot

Asafstand: 85mm  
 Breedte voorplaat: 24mm  
 Type voorplaat: Hoekig  
 Materiaal voorplaat: Inox  
 Type sleutling: Dag/Nacht valschoot  
 Draairichting: Keerbaar  
 Kruknoot: 8mm  
 Sluiting: 15mm  
 Sluitlengte: 22mm  
 Type sleutel: Cilinderslot  
 Lengte voorplaat: 238mm

Inox voorplaat enkel te bestellen per 10

### Rechthoekige voorplaat 22mm

20mm	I 741N202 INOX
	I 741N203 MESSING
25mm	I 741N252 INOX
	I 741N253 MESSING
30mm	I 741N302 INOX
	I 741N303 MESSING
35mm	I 741N352 INOX
	I 741N353 MESSING
<b>Sluitplaat</b>	
I 038030	

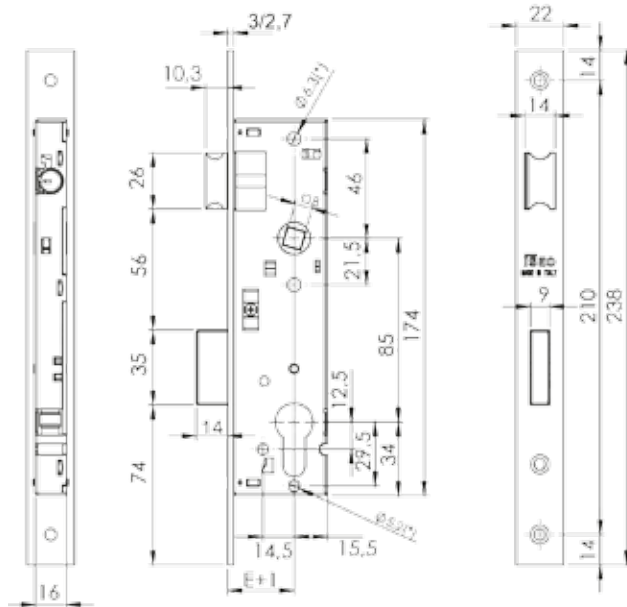

# Iseo Performa

1-punt cilinderslot

## 1-punt cilinderslot

Asafstand: 92mm  
 Breedte voorplaat: 24mm  
 Type voorplaat: Hoekig Vlak of U-profiel  
 Materiaal voorplaat: Inox  
 Type sluiting: Dag/Nacht  
 Draairichting: Keerbaar  
 kruknoop: 8mm  
 Sluiting: 1-toers  
 Sluitlengte: 20mm  
 Type sleutel: cilinderslot  
 Lengte voorplaat: 313mm  
 Voorplaat 16mm enkel per 10 stuks

Andere eigenschappen:  
 Gesloten slotkast met 15mm breedte  
 Voorzien van Patentgaten  
 Hoge corrosiebestendigheid  
 > 200.000 openingen/sluitingen onder 120N belasting

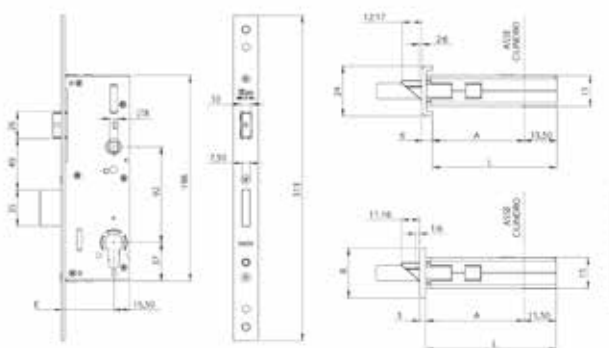

BACKSET	A	L
30	23	38.5
35	28	43.5
40	33	48.5

BACKSET	A	L	B
30	27	42.5	
35	32	47.5	16
40	37	52.5	
30	27	42.5	
35	32	47.5	20
40	37	52.5	
30	27	42.5	
35	32	47.5	24
40	37	52.5	

Platte voorplaat 16mm	
30mm	I 7212133028
35mm	I 7212133528
40mm	I 7212134028
Platte voorplaat 20mm	
30mm	I 7212123028
35mm	I 7212123528
40mm	I 7212124028
Platte voorplaat 24mm	
30mm	I 7212113028
35mm	I 7212113528
40mm	I 7212114028
U voorplaat 24mm	
30mm	I 7212213028
35mm	I 7212213528
40mm	I 7212214028
Onderdelen	
Rolnok	I 040940



your world safely locked //®



# Iseo Blindo

Veiligheidsvalslot

132

## Veiligheidsvalslot

Asafstand: 92mm  
 Breedte voorplaat: 22 en 24mm  
 Type voorplaat: Hoekig Vlak of U-profiel  
 Materiaal voorplaat: Inox ( behalve U22 zwart gelakt)  
 Type sluiting: Dag/Nacht valschoot  
 Draairichting: keerbaar  
 Kruknoot: 8mm  
 Sluiting: 1-toers  
 Sluitlengte: 27mm  
 Type sleutel: Cilinderslot  
 Lengte voorplaat: 326mm

Andere eigenschappen:  
 Gesloten slotkast  
 Gepantserde nachtschoot weerstaat aan een zijwaartse kracht van meer dan 1000kg en 600kg frontale kracht  
 Beschikbaar met rolknop  
 Voorzien van patentgaten

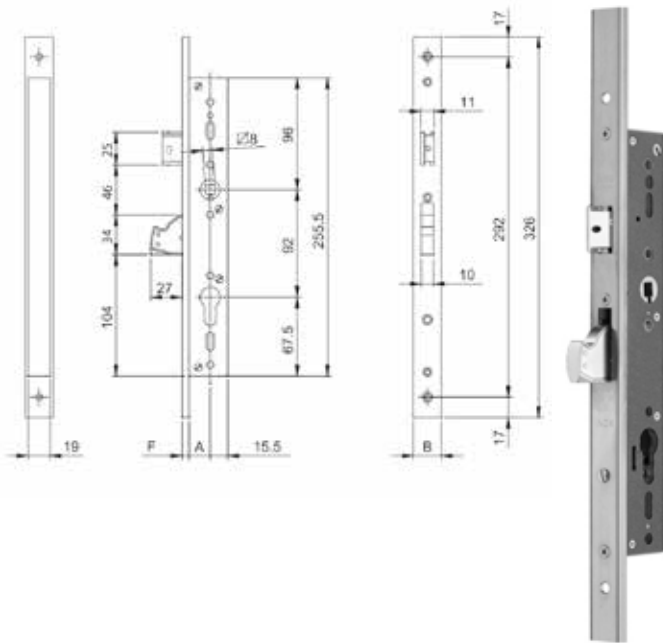

### Platte voorplaat 22mm

25mm	I 791112252	VALSLOT ALU 92/25-PL/22
30mm	I 791112302	VALSLOT ALU 92/30-PL/22
35mm	I 791112352	VALSLOT ALU 92/35-PL/22
40mm	I 791112402	VALSLOT ALU 92/40-PL/22

### Platte voorplaat 24mm

25mm	I 791110252	VALSLOT ALU 92/25-PL/24
30mm	I 791110302	VALSLOT ALU 92/30-PL/24
35mm	I 791110352	VALSLOT ALU 92/35-PL/24
40mm	I 791110402	VALSLOT ALU 92/40-PL/24

### U voorplaat 22mm

25mm	I 791150250	VALSLOT ALU 92/25-U/22
30mm	I 791150300	VALSLOT ALU 92/30-U/22
35mm	I 791150350	VALSLOT ALU 92/35-U/22
40mm	I 791150400	VALSLOT ALU 92/40-U/22

### U voorplaat 24mm

25mm	I 791100252	VALSLOT ALU 92/25-U/24
30mm	I 791100302	VALSLOT ALU 92/30-U/24
35mm	I 791100352	VALSLOT ALU 92/35-U/24
40mm	I 791100402	VALSLOT ALU 92/40-U/24

### Onderdelen

I 040801	ROLKNOP - E 25
I 040802	ROLKNOP - E 30
I 040803	ROLKNOP - E 35
I 040804	ROLKNOP - E 40
I 040816	STOP DAGSCHOOT 25MM TOT 65MM

Code					
Art.	E	A	B	C	F
PREL 20	25	30	37,5	44	5
30	37	43,5			
35	39	47,5			
40	37	52,5			

Code					
Art.	E	A	B	C	F
PREL 30	25	30	37,5	44	7
30	39	43,5			
35	39	47,5			
40	39	52,5			

Code					
Art.	E	A	B	C	F
PREL 30	25	30	37,5	44	8
30	39	43,5			
35	39	47,5			
40	39	52,5			

# Wilka Wi 1433

Veiligheidssmaldeurslot

133

## Veiligheidssmaldeurslot

Asafstand: 92mm  
 Breedte voorplaat: 20 en 24mm  
 Type voorplaat: Hoekig  
 Materiaal voorplaat: Verzinkt  
 Type sluiting: Dag/nacht  
 Draairichting: Keerbaar  
 Kruknoot: 8mm  
 Sluiting: 1-toers  
 Sluitlengte: 15mm  
 Type sleutel: Cilinderslot  
 Lengte voorplaat: 245mm

Andere eigenschappen:  
 Geschroefde slotkast , boven en onder verzinkt

Platte voorplaat 16mm	
25mm	WI 1433/25/K/16
30mm	WI 1433/30/K/16
35mm	WI 1433/35/K/16
40mm	WI 1433/40/K/16
45mm	WI 1433/45/K/16
Platte voorplaat 24mm	
20mm	WI 1433/20/K/24
25mm	WI 1433/25/K/24
30mm	WI 1433/30/K/24
35mm	WI 1433/35/K/24
40mm	WI 1433/40/K/24
45mm	WI 1433/45/K/24
Sluitplaten	
WI 9507000003	

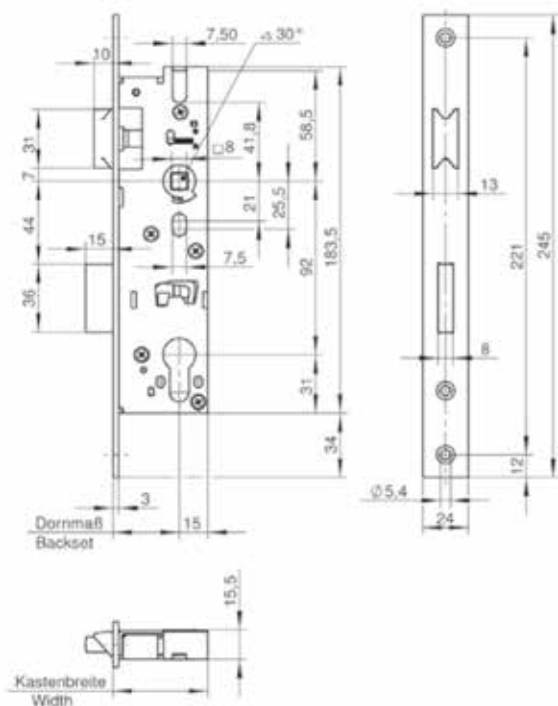

your world safely locked //®

# Wilka Wi 1438

Veiligheidssmalslot

134

## Veiligheidssmaldeurslot

Asafstand: 92mm  
 Breedte voorplaat: 24mm  
 Type voorplaat: Hoekig  
 Materiaal voorplaat: Verzinkt  
 Type sluiting: Dag/nacht  
 Draairichting: Keerbaar  
 Kruknoot: 8mm  
 Sluiting: 1-toers  
 Sluitlengte: 20mm  
 Type sleutel: cilinderslot  
 Lengte voorplaat: 245mm

Andere eigenschappen:  
 Nachtschoot met 2 staalf stiften tegen het afzagen  
 Geschroefde slotkast, verzinkt boven en onder

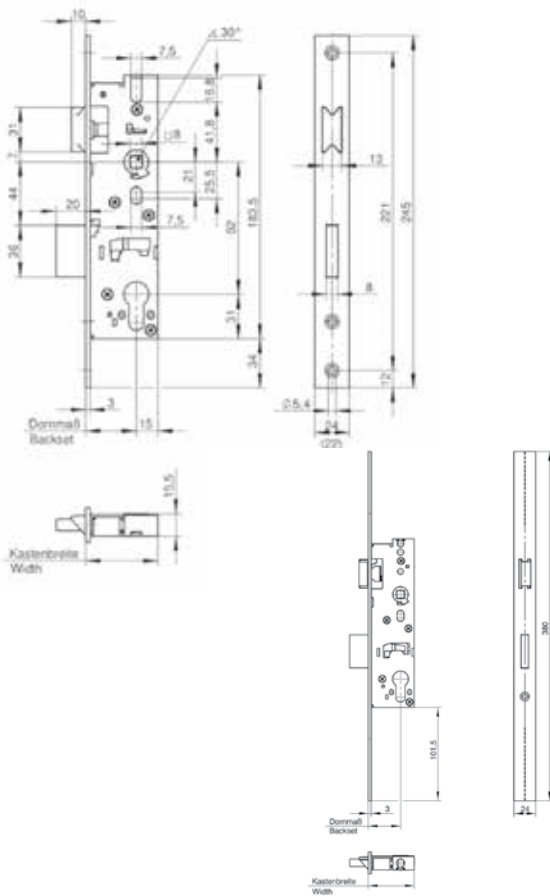

Platte voorplaat 16mm	
30mm	WI 1438/30/K/16X380
35mm	WI 1438/35/K/16X380
40mm	WI 1438/40/K/16X380
45mm	WI 1438/45/K/16X380
Platte voorplaat 24mm	
25mm	WI 1438/25/K/24
	WI 1438/25/K/24X380
30mm	WI 1438/30/K/24
	WI 1438/30/K/24X380
35mm	WI 1438/35/K/24
	WI 1438/35/K/24X380
40mm	WI 1438/40/K/24
	WI 1438/40/K/24X380
45mm	WI 1438/45/K/24
	WI 1438/45/K/24X380
Sluitplaten	
	WI 9507000003



your world safely locked //®

# Bmh B 34PZW

Insteekcilinderslot

## Cilinder insteekslot

Asafstand: 92mm  
 Breedte voorplaat: 22mm  
 Type voorplaat: Hoekig  
 Materiaal voorplaat:  
 Type sluiting: Dag/Nacht  
 Draairichting: Niet keerbaar  
 Kruknoot: 10 mm  
 Sluiting: 2-toers  
 Sluitlengte: 22mm  
 Type sleutel: cilinderslot  
 Lengte voorplaat: 280mm

Andere eigenschappen:  
 Dag/nacht schoten in vernikkeld staal  
 Steeds opdek  
 Kruknoot in 10mm  
 Gesloten slotkast ( Behalve 50mm)

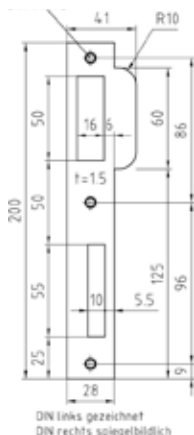

### Hoekige voorplaat 20mm

55mm	Din R	B 34PZW/55/20/K/DR
60mm	Din L	B 34PZW/60/22/K/DL
	Din R	B 34PZW/60/22/K/DR
65mm	Din L	B 34PZW/65/22/K/DL
	Din R	B 34PZW/65/22/K/DR

### Hoekige voorplaat 22mm

50mm	Din L	B 34PZW/50/22/K/DL
	Din R	B 34PZW/50/22/K/DR
55mm	Din L	B 34PZW/55/22/K/DL
	Din R	B 34PZW/55/22/K/DR

### Hoekige voorplaat 24mm

50mm	Din L	B 34PZW/50/24/K/DL
	Din R	B 34PZW/50/24/K/DR
55mm	Din L	B 34PZW/55/24/K/DL
	Din R	B 34PZW/55/24/K/DR
60mm	Din L	B 34PZW/60/24/K/DL
	Din R	B 34PZW/60/24/K/DR
65mm	Din L	B 34PZW/65/24/K/DL
	Din R	B 34PZW/65/24/K/DR
70mm	Din L	B 34PZW/70/24/K/DL
	Din R	B 34PZW/70/24/K/DR

### Sluitplaat

B S24 LACKIERT DL
B S24 LACKIERT DR

# Bmh B 34PZW

Insteekcilinderslot

136

## Cilinder insteekslot

Asafstand: 92mm  
 Breedte voorplaat: 22mm  
 Type voorplaat: Afgerond  
 Materiaal voorplaat:  
 Type sluiting: Dag/Nacht  
 Draairichting: Niet keerbaar  
 Kruknoot: 10 mm  
 Sluiting: 2-toers  
 Sluitlengte: 22mm  
 Type sleutel: cilinderslot  
 Lengte voorplaat: 280mm



Andere eigenschappen:  
 Dag/nacht schoten in vernikkeld staal  
 Steeds opdek  
 Kruknoot in 10mm  
 Gesloten slotkast ( Behalve 50mm)

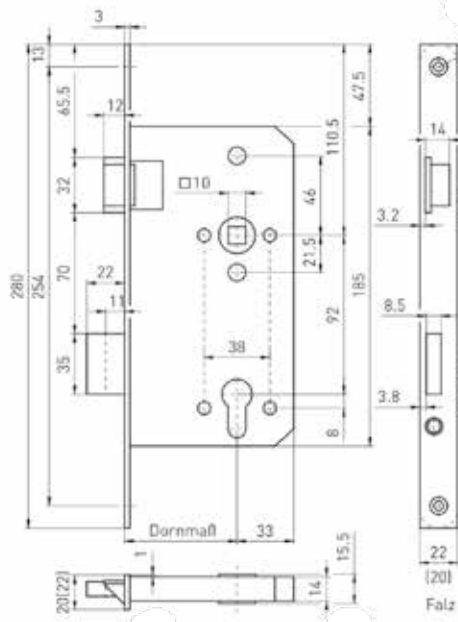

### Afgeronde voorplaat 20mm

50mm	Din L	B 34PZW/50/20/0/DL
	Din R	B 34PZW/50/20/0/DR
55mm	Din L	B 34PZW/55/20/0/DL
	Din R	B 34PZW/55/20/0/DR
60mm	Din L	B 34PZW/60/20/0/DL
	Din R	B 34PZW/60/20/0/DR
65mm	Din L	B 34PZW/65/20/0/DL
	Din R	B 34PZW/65/20/0/DR

### Afgeronde voorplaat 24mm

50mm	Din L	B 34PZW/50/24/0/DL
	Din R	B 34PZW/50/24/0/DR
55mm	Din L	B 34PZW/55/24/0/DL
	Din R	B 34PZW/55/24/0/DR
70mm	Din L	B 34PZW/70/24/0/DL
	Din R	B 34PZW/70/24/0/DR

### Afgeronde voorplaat 26mm

70mm	Din L	B 34PZW/70/26/0/DL
	Din R	B 34PZW/70/26/0/DR

### Sluitplaat

B S24 LACKIERT DL
B S24 LACKIERT DR

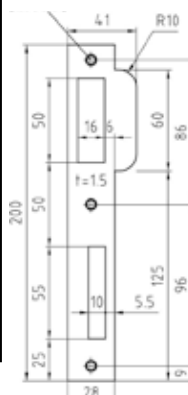

DIN links geteekend  
 DIN rechts spiegelbeeldig

# Wilka Wi 1435

Veiligheidsvalslot

137

## Veiligheidsvalslot

Asafstand: 92mm  
 Breedte voorplaat: 24mm  
 Type voorplaat: hoekig  
 Materiaal voorplaat: verzinkt  
 Type sluiting: Valschoot  
 Draairichting: keerbaar  
 Kruknoot: nvt  
 Sluiting:  
 Sluitlengte: 36mm  
 Type sleutel: cilinderslot  
 Lengte voorplaat: 245mm



Andere eigenschappen:  
 Zeer sterke nachtvalschoot met 2 staalgeharte stiften tegen het doorzagen.  
 Geschroefde open slotkast in verzinkt metaal  
 Bestand tegen een zeer hoge zijdelings belasting

### Platte voorplaat 24mm

25mm	WI 1435/25/K/24
30mm	WI 1435/30/K/24
35mm	WI 1435/35/K/24
40mm	WI 1435/40/K/24

### Sluitplaten

WI 9513000001 VERZINKT
WI 9513000002 INOX

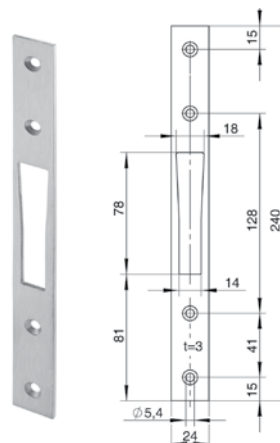
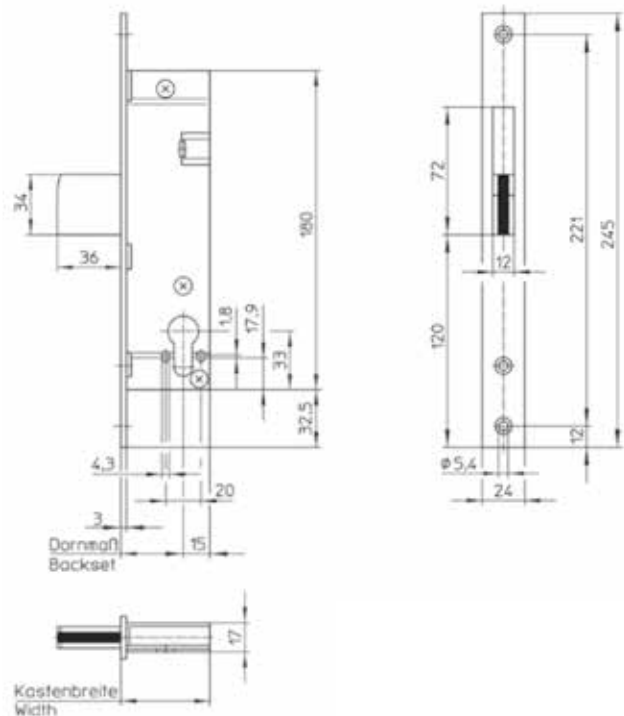

your world safely locked //®

# Wilka Wi 7667

Zelfvergrendelend paniekslot

138

## Zelfvergrendelend paniekslot

Asafstand: 92mm  
 Breedte voorplaat: 24mm  
 Type voorplaat: hoeking  
 Materiaal voorplaat: Inox  
 Type sluitling: Dag/Nacht  
 Draairichting:  
 Kruknoot: 9mm  
 Sluiting: Automatisch  
 Sluitlengte: 20mm  
 Type sleutel: cilinderslot  
 Lengte voorplaat: 245mm

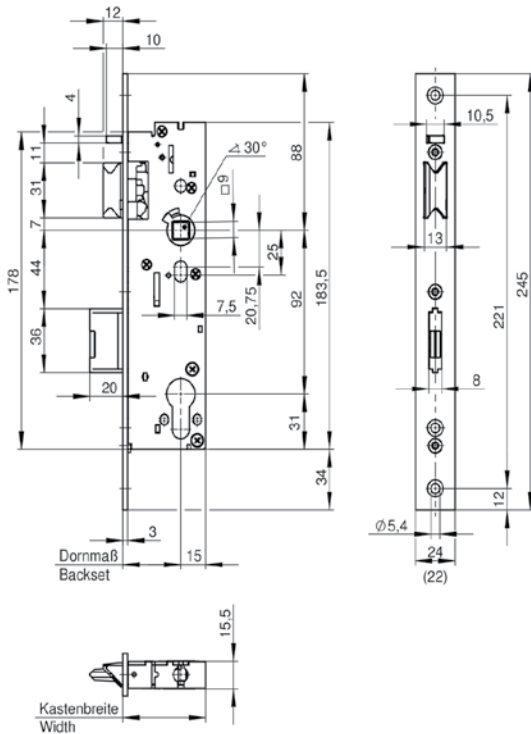

### Platte voorplaat

30mm	WI 7667/30/K/24
35mm	WI 7667/35/K/24
40mm	WI 7667/40/K/24
45mm	WI 7667/45/K/24



# Wilka Wi 1436

Veiligshaakslot

139

## Veiligheidshaakslot

Asafstand: nvt  
 Breedte voorplaat: 24mm  
 Type voorplaat: hoekig  
 Materiaal voorplaat: verzinkt  
 Type sluiting: haakschoot  
 Draairichting: keerbaar  
 Kruknoot: nvt  
 Sluiting: 1-toers  
 Sluitlengte: 24,5mm  
 Type sleutel: cilinderslot  
 Lengte voorplaat: 245mm

Andere eigenschappen:

Zeer sterk haakschoot met 2 staalgeharte stiften tegen het doorzagen.

Geschroefde open slotkast in verzinkt metaal.

Bestand tegen een hoge zijdelingse belasting.

### Platte voorplaat 24mm

25mm	WI 1436/25/K/24
	WI 1436/25/K/I/24
30mm	WI 1436/30/K/24
35mm	WI 1436/35/K/24
40mm	WI 1436/40/K/24

### Sluitplaten

WI 9513000001 VERZINKT

WI 9513000002 INOX

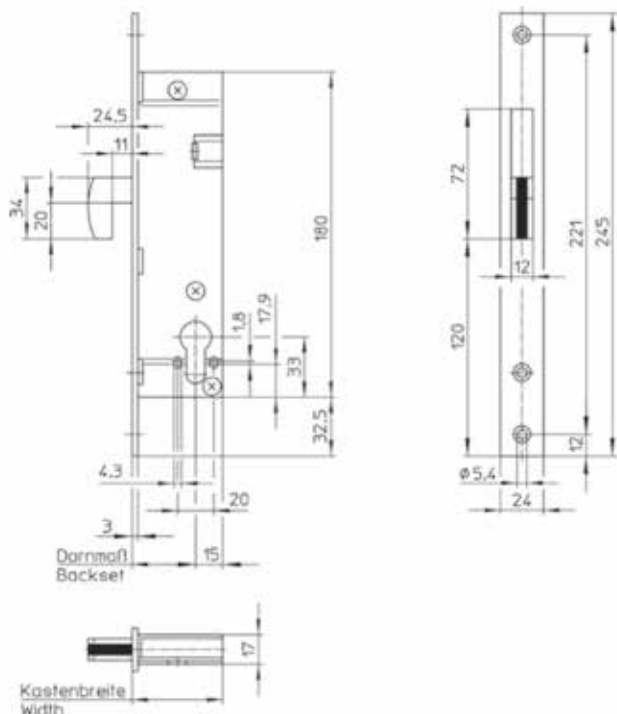
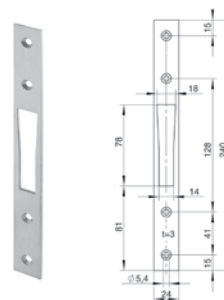

your world safely locked //®

Versie v1.1.2

Info@dombrecht.eu www.dombrecht.eu  
 Tel: 052/44 74 84 Fax: 052/44 90 52



**Dombrecht**  
DISTRIBUTION

# Dyla 100

Insteekslot met baardsleutel

140

## Binnendeurslot met baardsleutel

Asafstand: 110mm  
 Breedte voorplaat: 22mm  
 Type voorplaat: afgerond/hoekig  
 Materiaal voorplaat: gelakt  
 Type sleuting: dag/nacht  
 Draairichting: keerbaar  
 Kruknoot: 8mm  
 Sluiting: 1-toers  
 Sluitlengte: 20mm  
 Type sleutel: baardsleutel  
 Lengte voorplaat: 265mm

Andere eigenschappen:  
 Inclusief sluitplaat

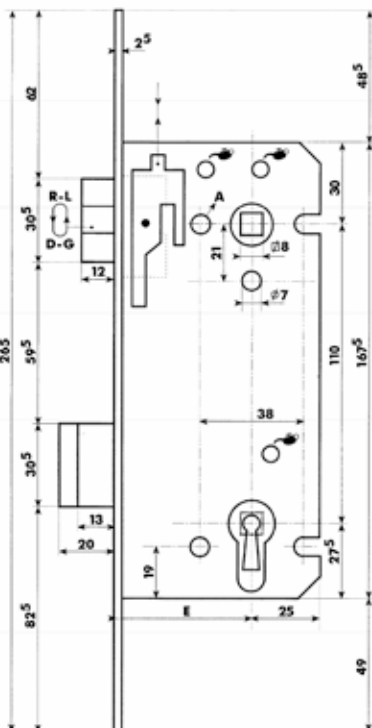

### Hoekige voorplaat

50mm DY 100/H/50

55mm DY 100/H/55

DY 100/H/55/OPDEK/L

DY 100/H/55/OPDEK/R

60mm DY 100/H/60

DY 100/H/60/OPDEK/L

DY 100/H/60/OPDEK/R

65mm DY 100/H/65

### Afgeronde voorplaat

50mm DY 100/O/50

55mm DY 100/O/55

DY 100/O/55/OPDEK/R

60mm DY 100/O/60

# Dyla 102

Insteekslot

141

## Insteekcilinderslot

Asafstand: 110mm  
Breedte voorplaat: 22mm  
Type voorplaat: Afgerond/Hoekig  
Materiaal voorplaat: gelakt  
Type sluiting: Dag/Nacht  
Draairichting: keerbaar  
Kruknoot: 8mm  
Sluiting: 2-toers  
Sluitlengte: 20mm  
Type sleutel: cilinderslot  
Lengte voorplaat: 265mm

Andere eigenschappen:  
Inclusief sluitplaat

### Hoekige voorplaat

50mm	DY 102/H/50
	DY 102/H/50/OPDEK
55mm	DY 102/H/55
	DY 102/H/55/OPDEK L
	DY 102/H/55/OPDEK R
60mm	DY 102/H/60
	DY 102/H/60/OPDEK L

### Afgeronde voorplaat

50mm	DY 102/O/50
55mm	DY 102/O/55
60mm	DY 102/O/60

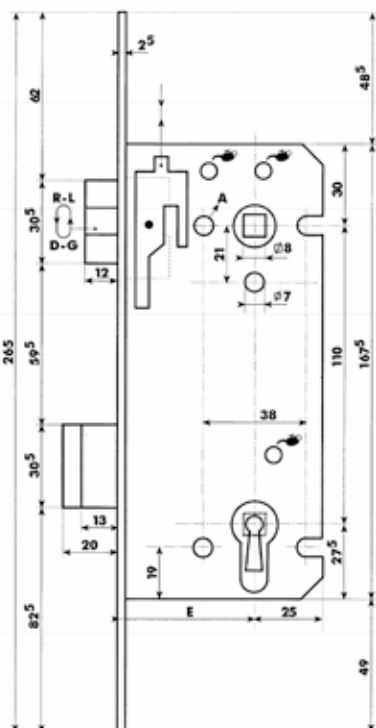

your world safely locked //®

Versie v1.1.2

Info@dombrecht.eu www.dombrecht.eu  
Tel: 052/44 74 84 Fax: 052/44 90 52



**Dombrecht**  
DISTRIBUTION

# Dyla 1022

Insteekslot met baardsleutel en ronde schoten

142

## Binnendeurslot met baardsleutel en ronde schoten

Asafstand: 110mm  
 Breedte voorplaat: 22mm  
 Type voorplaat: Afgerond/hoekig  
 Materiaal voorplaat: gelakt  
 Type sluiting: Dag/nacht ronde schoten  
 Draairichting: keerbaar  
 Kruknoot: 8mm  
 Sluiting: 1-toer  
 Sluitlengte: 13mm  
 Type sleutel: Baardsleutel  
 Lengte voorplaat: 265mm

Andere eigenschappen:  
 Inclusief sluitplaat  
 Ronde dag en nachtschoten  
 Leverbaar op 72mm ( Type 1067)

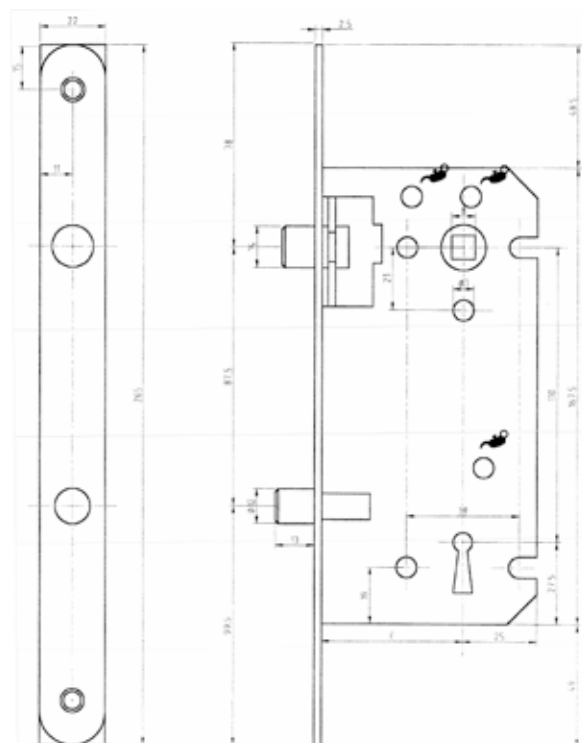

### Hoekige voorplaat

45mm DY 1022/45/H

50mm DY 1022/50/H

55mm DY 1022/55/H

60mm DY 1022/60/H

65mm DY 1022/65/H

### Afgeronde voorplaat

50mm DY 1022/50/O

DY 1022/50/O/MESSING

55mm DY 1022/55/O

DY 1022/55/O/MESSING

60mm DY 1022/60/O

DY 1022/60/O/MESSING

# Dyla 1601

Veiligheidscilinderslot

143

## Veiligheidscilinderslot

Asafstand: 110mm  
Breedte voorplaat: 25mm  
Type voorplaat: Hoekig  
Materiaal voorplaat: gelakt  
Type sluiting: Dag/nacht  
Draairichting: Keerbaar  
Kruknoot: 8mm  
Sluiting: 2-toers  
Sluitlengte 20mm  
Type sleutel: cilinderslot  
Lengte voorplaat: 265mm

Andere eigenschappen:  
Versterkte nachtschoot met stalen stiften  
Versterkingsringen rond de kruknoot  
Beschikbaar in optie met Inox voorplaat

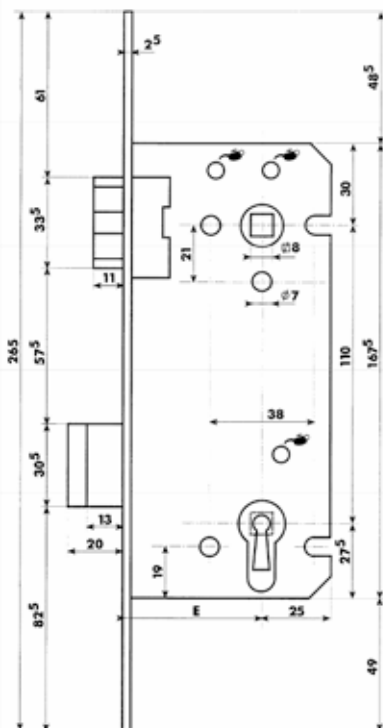

### Hoekige voorplaat

45mm	DY 1601/45/H/I/R
	DY 1601/45/H/L/OPDEK
50mm	DY 1601/50/H
	DY 1601/50/H/L/OPDEK
	DY 1601/50/H/R/OPDEK
55mm	DY 1601/55/H
	DY 1601/55/H/L/OPDEK
	DY 1601/55/H/R/OPDEK
60mm	DY 1601/60/H
	DY 1601/60/H/L/OPDEK
	DY 1601/60/H/R/OPDEK
65mm	DY 1601/65/H
70mm	DY 1601/70/H

# Dyla 159

Insteekslot lange voorplaat

144

## Insteekslot met lange voorplaat

Asafstand: 110mm  
 Breedte voorplaat: 25mm  
 Type voorplaat: Hoekig  
 Materiaal voorplaat: Gelakt  
 Type sluiting: Dag/nacht  
 Draairichting: vanaf 50mm keerbaar  
 Kruknoot: 8mm  
 Sluiting: 2-toers  
 Sluitlengte: 20mm  
 Type sleutel: cilinderslot  
 Lengte voorplaat: 300mm

Andere eigenschappen:  
 Extra lange voorplaat  
 versterkte nachtschoot met stalen stiften  
 versterkingsringen rond de kruknoot

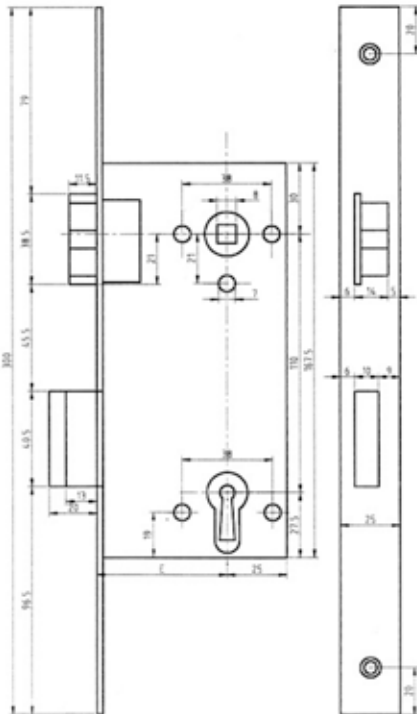

## Hoekige voorplaat

40mm	DY 159/H/40/L
	DY 159/H/40/R
45mm	DY 159/H/45/L
	DY 159/H/45/R
50mm	DY 159/H/50
55mm	DY 159/H/55
60mm	DY 159/H/60
65mm	DY 159/H/65
70mm	DY 159/H/70
75mm	DY 159/H/75
80mm	DY 159/H/80
85mm	DY 159/H/85
90mm	DY 159/H/90
95mm	DY 159/H/95
100mm	DY 159/H/100/L
	DY 159/H/100/R
110mm	DY 159/H/110/L
	DY 159/H/110/R
120mm	DY 159/H/120/L
	DY 159/H/120/R

# Dyla 601

Insteekslot profielcilinder

145

## Insteekcilinderslot

Asafstand: 110mm  
Breedte voorplaat: 25mm  
Type voorplaat: Afgerond/Hoekig  
Materiaal voorplaat: gelakt  
Type sluiting: Dag/nacht  
Draairichting: 40-45mm niet keerbaar  
Kruknoot: 8mm  
Sluiting: 2-toers  
Sluitlengte: 20mm  
Type sleutel: cilinderslot  
Lengte voorplaat: 265mm

Andere eigenschappen:  
Inclusief sluitplaat  
Beschikbaar voor opdek deuren

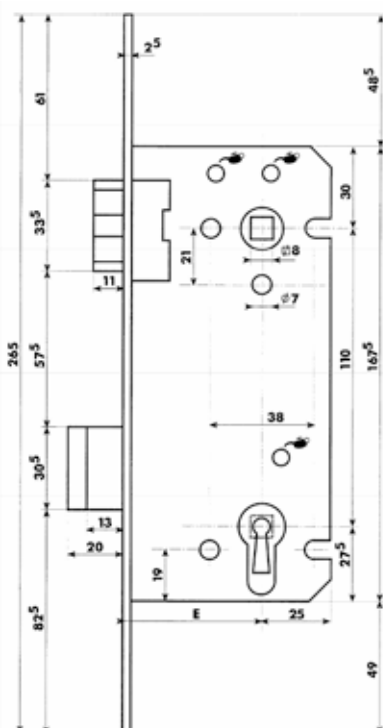

## Hoekige voorplaat

35mm	DY 601/H/35/L
	DY 601/H/35/OPDEK R
	DY 601/H/35/R
40mm	DY 601/H/40/L
	DY 601/H/40/R
45mm	DY 601/H/45/L
	DY 601/H/45/OPDEK L
	DY 601/H/45/OPDEK R
	DY 601/H/45/R
50mm	DY 601/H/50/OPDEK L
	DY 601/H/50/OPDEK R
55mm	DY 601/H/55/OPDEK L
	DY 601/H/55/OPDEK R
60mm	DY 601/H/60/OPDEK L
	DY 601/H/60/OPDEK R
65mm	DY 601/H/65
	DY 601/H/65/OPDEK L
	DY 601/H/65/OPDEK R
70mm	DY 601/H/70
75mm	DY 601/H/75
80mm	DY 601/H/80
85mm	DY 601/H/85
90mm	DY 601/H/90
95mm	DY 601/H/95
100mm	DY 601/H/100
105mm	DY 601/H/105
110mm	DY 601/H/110
120mm	DY 601/H/120

## Afgeronde voorplaat

45mm	DY 601/O/45/OPDEK L
50mm	DY 601/O/50/OPDEK L
	DY 601/O/50/OPDEK R
60mm	DY 601/O/60/OPDEK R

your world safely locked //®

Versie v1.1.2

Info@dombrecht.eu www.dombrecht.eu  
Tel: 052/44 74 84 Fax: 052/44 90 52



**Dombrecht**  
DISTRIBUTION

# Fiam Penslot

Penslot met kruissleutel

146

## Penslot met kruissleutel

Asafstand: nvt  
Breedte voorplaat: 21mm  
Type voorplaat: chrome plated  
Materiaal voorplaat: Staal  
Draairichting: Keerbaar  
Kruknoot: Nvt  
Sluiting: 1-toers  
Sluitlengte: 21mm  
Type sleutel: kruissleutel  
Lengte voorplaat: 120mm  
Met 3 sleutels  
Met sluitkom

50mm	F 14011050	MET KRUISSLEUTEL
	F 14011050 KA	KA KRUISSLEUTEL
55mm	F 14501155	SKG VOOR CILINDER
60mm	F 14011060	MET KRUISSLEUTEL
	F 14011060 KA	KA KRUISSLEUTEL

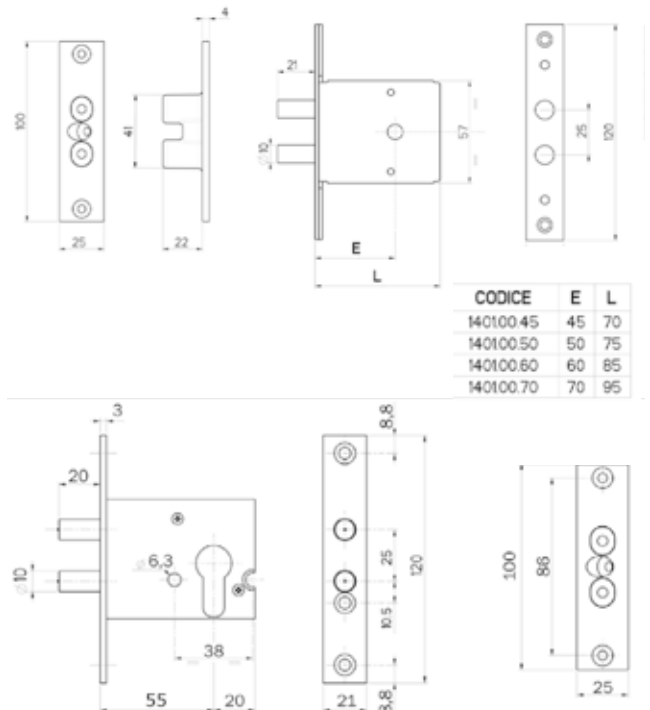

your world safely locked //®

# Bmh B 114

Nacht bijzetslot

## Nachtschoot bijzetslot

Asafstand: Nvt  
 Breedte voorplaat: 20 & 24mm  
 Type voorplaat: Hoekig  
 Materiaal voorplaat: Gelakt  
 Draairichting: nvt  
 Kruknoot: nvt  
 Sluiting: 2-toers  
 Sluitlengte: 22mm  
 Type sleutel: cilinderslot  
 Lengte voorplaat: 160mm

### Met baardsleutel voorplaat 24mm

55mm B 114/BB/24/K/55-2

60mm B 114/BB/24/K/60-2

### Voor profielcilinder Voorplaat 20mm

50mm B 114/PZ/20/K/50-1 toers

55mm B 114/PZ/20/K/55-2

60mm B 114/PZ/20/K/60-2

70mm B 114/PZ/20/K/70-2

80mm B 114/PZ/20/K/80-2

90mm B 114/PZ/20/K/90-2

### Voor profielcilinder voorplaat 24mm

55mm B 114/PZ/24/K/55-2

60mm B 114/PZ/24/K/60-2

70mm B 114/PZ/24/K/70-2

100mm B 114/PZ/24/K/100-2

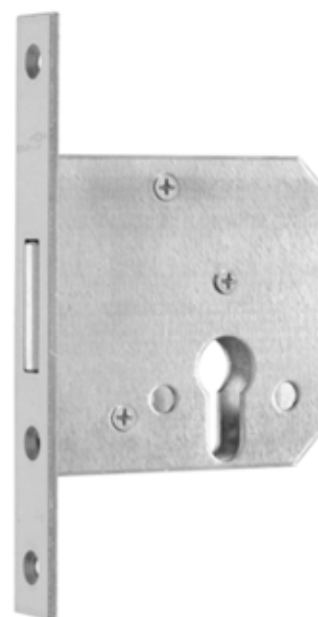
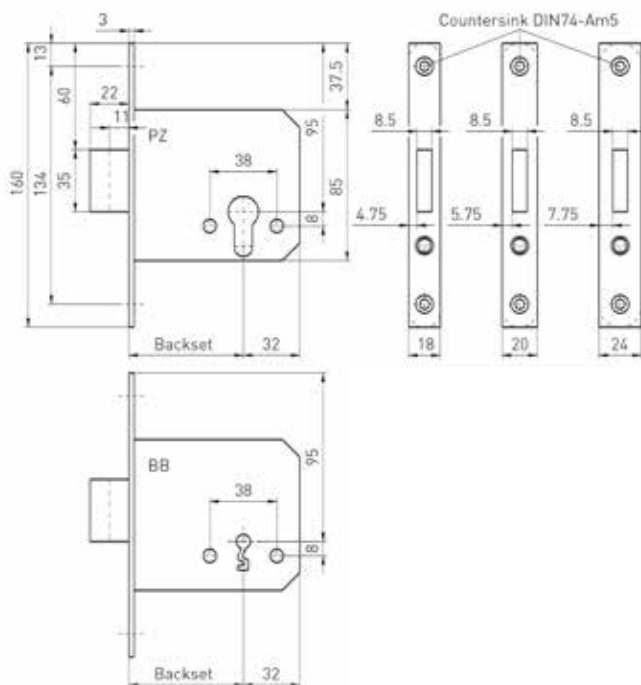

# Dyla Sleutels

Nieuwe nummering

148

DY S DBS 1	SLEUTEL NR 1
DY S DBS 2	SLEUTEL NR 2
DY S DBS 3	SLEUTEL NR 3
DY S DBS 4	SLEUTEL NR 4
DY S DBS 5	SLEUTEL NR 5
DY S DBS 6	SLEUTEL NR 6
DY S DBS 7	SLEUTEL NR 7
DY S DBS 8	SLEUTEL NR 8
DY S DBS 9	SLEUTEL NR 9
DY S DBS 10	SLEUTEL NR 10
DY S DBS 11	SLEUTEL NR 11
DY S DBS 12	SLEUTEL NR 12
DY S DBS 13	SLEUTEL NR 13
DY S DBS 14	SLEUTEL NR 14
DY S DBS 15	SLEUTEL NR 15
DY S DBS 16	SLEUTEL NR 16
DY S DBS 17	SLEUTEL NR 17
DY S DBS 18	SLEUTEL NR 18
DY S DBS 19	SLEUTEL NR 19
DY S DBS 20	SLEUTEL NR 20
DY S DBS 21	SLEUTEL NR 21
DY S DBS 22	SLEUTEL NR 22
DY S DBS 23	SLEUTEL NR 23
DY S DBS 24	SLEUTEL NR 24
DY S DBS 25	SLEUTEL NR 25
DY S DBS 26	SLEUTEL NR 26
DY S DBS 27	SLEUTEL NR 27
DY S DBS 28	SLEUTEL NR 28
DY S DBS 29	SLEUTEL NR 29
DY S DBS 30	SLEUTEL NR 30
DY S DBS 31	SLEUTEL NR 31
DY S DBS 32	SLEUTEL NR 32

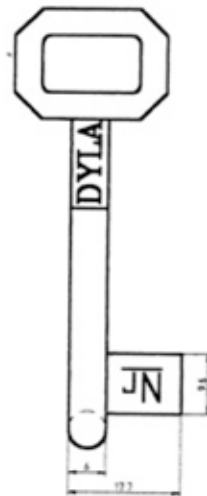

Type	R/L	Ondiep	Trap-af	Tand-in	Diep
	1 L	nr° 1 nr° 1	nr° 2	nr° 3 nr° 5	nr° 4 nr° 3
	1 R	nr° 5 nr° 2	nr° 6	nr° 7 nr° 6	nr° 8 nr° 4
	2 L	nr° 9 nr° 7	nr° 10	nr° 11 nr° 11	nr° 12 nr° 9
	2 R	nr° 13 nr° 8	nr° 14	nr° 15 nr° 12	nr° 16 nr° 10
	3 L	nr° 17 nr° 13	nr° 18	nr° 19 nr° 17	nr° 20 nr° 15
	3 R	nr° 21 nr° 14	nr° 22	nr° 23 nr° 18	nr° 24 nr° 16
	4 L	nr° 25 nr° 19	nr° 26	nr° 27 nr° 23	nr° 28 nr° 21
	4 R	nr° 29 nr° 20	nr° 30	nr° 31 nr° 24	nr° 32 nr° 22

nr° .. = nieuw nummer  
nr° .. = oud nummer





# Meerpuntsloten



your world safely locked //®

Versie v1.1.2



**Dombrecht**  
DISTRIBUTION



## Sloten 72mm

# 154

### 154. MV Meerpuntslot MV11-11111-xxxx

Meerpuntslot met haken

### 155. MV Meerpuntslot MV11-11011-xxxx

Pinslot passende voor Furh, GU en KFV

### 156. MV Meerpuntslot MV11-15011-0308

2x2 rolhok passende voor KFV

### 157. SAB meerpuntpinslot

Verwisselbaar hoofdslot

## Sloten 85mm

# 158

### 158. Iseo Performa

Meerpuntslot

### 159. Iseo Performa

Meerpuntslot

## Sloten 92mm

# 160

### 160. Iseo Multiblindo classic

Veiligheidsvalsot

### 161. Iseo Multiblindo classic

Veiligheidsvalsot haak/pin

### 162. Iseo Performa

Veiligheidsvalsot haak/pin

### 163. Iseo Performa

Meerpunt met rechte schieter

### 164. Iseo Multiblindo easy exit

Zelfvergrendelend haak/pinslot met anti paniekt functie

### 165. MV meerpuntslot MV11-xxxxx-xxxx

Meerpuntslot met pinnen

### 166. MV meerpuntslot MV11-46011-xxxx

2x2 rolhok passende voor KFV

### 167. SAB meerpuntslot Haak of pin

Verwisselbaar hoofdslot

## Renovatiesloten

# 168

### 168. MV Renovatiesloten

Modulaire voorplaat

## Meerpunt onderdelen

# 170

### 170. Performa

### 171. Multiblindo emotion( exit) & easy ( exit)

### 172. Multiblindo classic

### 173. Iseo sluitplaten

153

your world safely locked //®



# MV Meerpuntslot

Haakslot passend voor Furh,GU en KFV

Asafstand: 72mm  
Breedte voorplaat: 16mm  
Type voorplaat: plat  
Materiaal voorplaat: gegalvaniseerd  
Draairichting: keerbaar  
Kruknoot: 8mm  
Sluiting: dubbeltoers  
Sluitlengte: 20mm  
Type sleutel: cilinder

Andere eigenschappen:  
Geschroefde slotkast  
Past voor KFV AS 2372b001 (oud model)

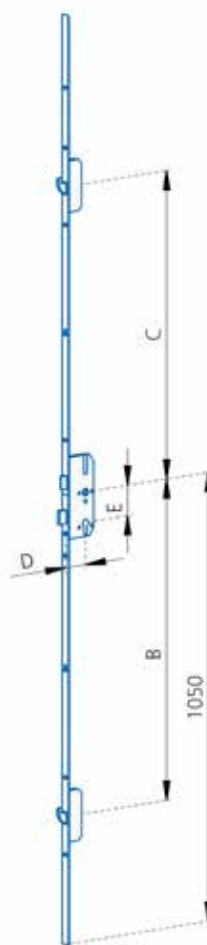

<b>Haken 16mm</b>		B	C	D	E
MV 11-11111-0308	3-PUNT HAAK 72/55 VP16 730-760	760	730	55	72
MV 11-94111-0308	3-PUNT HAAK 72/65 VP16 730-760	760	730	55	72
<b>Haken 18mm</b>					
MV 11-11111-1308	3-PUNT HAAK 72/55 VP18 730-760	760	730	55	72
MV 11-91111-1308	3-PUNT HAAK 72/65 VP18 730-760	760	730	65	72
<b>Haken 20mm</b>					
MV 11-01111-0308	3-PUNT HAAK 72/55 VP20 730-760	760	730	55	72
MV 11-91111-0308	3-PUNT HAAK 72/65 VP20 730-760	760	730	65	72
<b>Haken 24mm</b>					
MV 11-11111-2308	3-PUNT HAAK 72/55 VP24 730-760	760	730	55	72
MV 11-91111-2308	3-PUNT HAAK 72/65 VP24 730-760	760	730	65	72

your world safely locked //®

# MV Meerpuntslot

Pinslot passend voor Furh, GU en KFV

Asafstand: 72mm  
Breedte voorplaat: 16mm  
Type voorplaat: plat  
Materiaal voorplaat: gegalvaniseerd  
Draairichting: keerbaar  
Kruknoot: 8mm  
Sluiting: dubbeltoers  
Sluitlengte: 20mm  
Type sleutel: cilinder

Andere eigenschappen:  
Geschroefde slotkast  
Past op bestaande merken

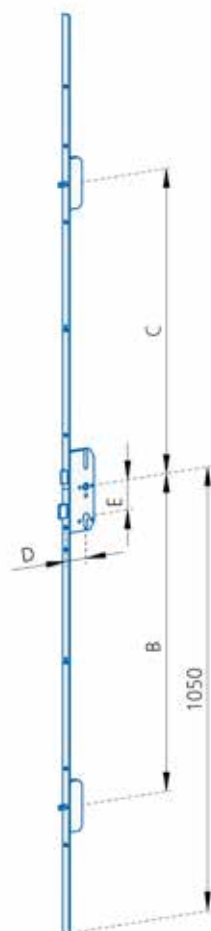

155

<b>Pinnen 16mm</b>		B	C	D	E	Fit to
MV 11-11011-0508	3-PUNT PIN 72/55 VP16 700-790	790	700	55	72	GU v-SB2
MV 11-11011-0608	3-PUNT PIN 72/55 VP16 730-760	790	730	55	72	KFV AS2372B001
MV 11-11011-1101	3-PUNT PIN 72/55/K/16MM KORT	402	387	55	72	
MV 11-11011-730850	3-PUNT PIN 72/55 VP16 730-850M	850	730	55	72	KFV AS2372
MV 11-11011-749742	3-PUNT PIN 72/55 VP16 749-742M	742	749	55	72	FURH 855GL
MV 11-11011-756734	3-PUNT PIN 72/55 VP16 756-734M	734	756	55	72	KFV AS2372B001
<b>Pinnen 18mm</b>						
MV 11-11011-7308501	3-PUNT PIN 72/55 VP18 730-850M	850	730	55	72	KFV AS2372
<b>Pinnen 20mm</b>						
MV 11-11011-0000	3-PUNT PIN 72/55/K/20MM KORT	402	387	55	72	

your world safely locked //®

Versie v1.1.2

Info@dombrecht.eu www.dombrecht.eu  
Tel: 052/44 74 84 Fax: 052/44 90 52



**Dombrecht**  
DISTRIBUTION

# MV Meerpuntslot

Rolnokslot passend voor Furh, GU en KfV

Asafstand: 72mm  
Breedte voorplaat: 16mm  
Type voorplaat: plat  
Materiaal voorplaat: Gegalvaniseerd  
Draairichting: Keerbaar  
Kruknoot: 8mm  
Sluiting: dubbeltoers  
Sluitlengte: 20mm  
Type sleutel: Cilinder

Andere eigenschappen:  
Geschroefde slotkast  
Past voor bestaande merken

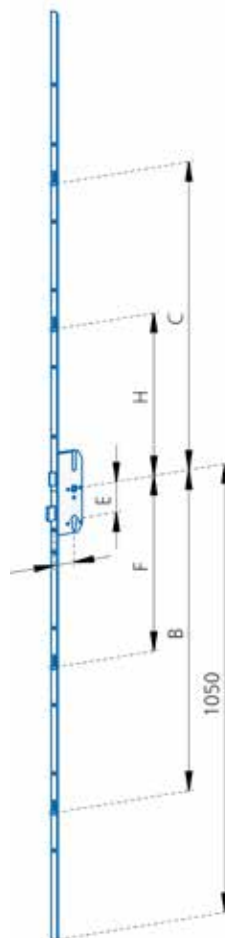

B C D F H Fit to

MV 11-15011-0308 5-PNT 2\*2 ROLNOK 72/55/16 KfV

770mm 810mm 55mm 360mm 550mm KfV AS8772



**Dombrecht**  
DISTRIBUTION

Info@dombrecht.eu www.dombrecht.eu  
Tel: 052/44 74 84 Fax: 052/44 90 52

your world safely locked //®

Versie v1.1.2

# SAB Serie 1600

Verwisselbaar hoofdslot

Asafstand: 72  
Breedte voorplaat: 16mm- 24mm  
Type voorplaat: Plat  
Materiaal voorplaat: inox  
Draairichting: Keerbaar  
Kruknoot: 8mm  
Sluiting: Dubbeltoers  
Sluitlengte:  
Type sleutel: profielcilinder  
Lengte voorplaat: 2400mm

Andere eigenschappen:  
Verwisselbaar hoofdslotkast  
Slotkasten verwisselbaar in alle combinaties  
Combineerbaar met 92mm sloten

## Rolnokken

SAB 160007250ZB 5-PUNT ROLNOK 72/50 16MM

SAB 160007255ZB 5-PUNT ROLNOK 72/55 16MM

## Pinnen

SAB 166007245ZB 3-PUNT PINNEN 72/45 16MM

SAB 166007250ZB 3-PUNT PINNEN 72/50 16MM

SAB 166007255ZB 3-PUNT PINNEN 72/55 16MM

SAB 166007265ZB 3-PUNT PINNEN 72/65 16MM

SAB 186007255ZB 3-PUNT PINNEN 72/55 18MM

## Middenslotkasten

SAB 160107245 MIDDENSLOT 72/45MM

SAB 160107250 MIDDENSLOT 72/50MM

SAB 160107255 MIDDENSLOT 72/55MM

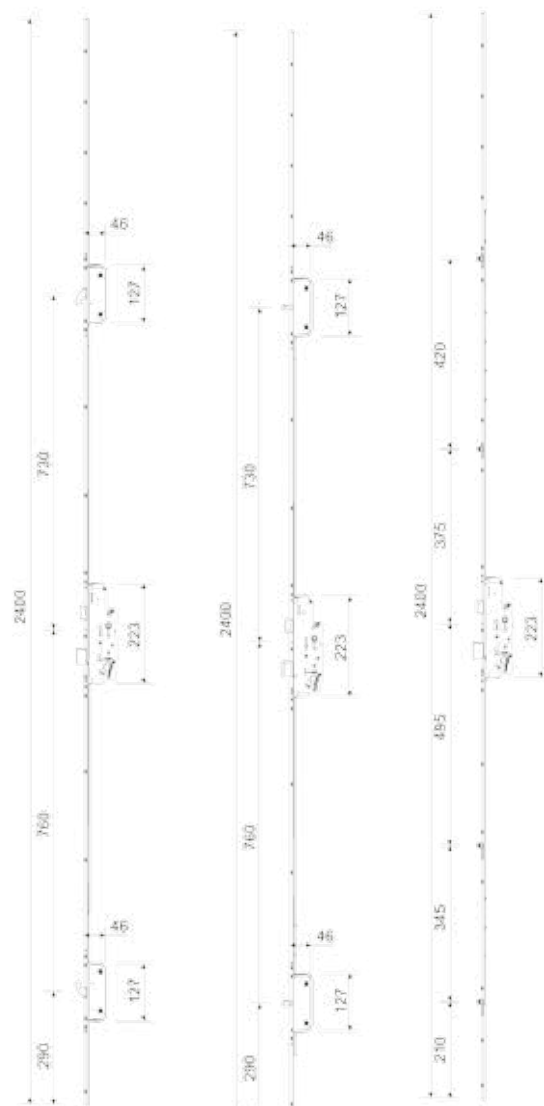

157

your world safely locked //®

Versie v1.1.2

Info@dombrecht.eu www.dombrecht.eu  
Tel: 052/44 74 84 Fax: 052/44 90 52



**Dombrecht**  
DISTRIBUTION

# Iseo Performa

Haak-pin meerpuntslot

Asafstand: 85mm  
 Breedte voorplaat: 24mm  
 Type voorplaat: U-profiel of plat  
 Materiaal voorplaat: Inox  
 Draairichting: keerbaar  
 Kruknoot: 8mm  
 Sluiting: Dubbeltoers  
 Sluitlengte: 20mm  
 Type sleutel: cilinder  
 Lengte voorplaat: 2300mm

Andere eigenschappen:  
 Patentgaten in het hoofdslot  
 Gesloten slotkast  
 Rotatiehoek: 20°  
 EN 12209:05  
 PR EN 15685:09  
 > 200.000 openingen onder 120N belasting

### U voorplaat 85MM

25mm	I 7255012528
60mm	I 7255016028

### Plat voorplaat 85MM

25mm	I 7255512528
------	--------------

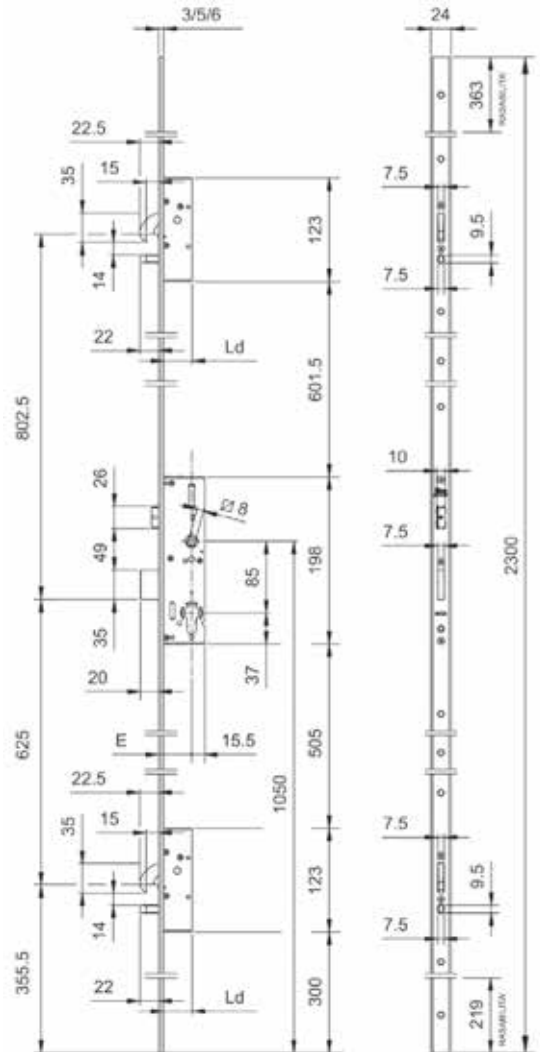

# Iseo Performa

Meerpuntslot met rechte schieter

Asafstand: 85mm  
 Breedte voorplaat: 24mm  
 Type voorplaat: U-profiel of plat  
 Materiaal voorplaat: Inox  
 Draairichting: keerbaar  
 Kruknoot: 8mm  
 Sluiting: Dubbeltoers  
 Sluitlengte: 20mm  
 Type sleutel: cilinder  
 Lengte voorplaat: 2300mm

Andere eigenschappen:  
 Patentgaten in het hoofdslot  
 Gesloten slotkast  
 Rotatiehoek: 20°  
 EN 12209:05  
 PR EN 15685:09  
 > 200.000 openingen onder 120N belasting

### U voorplaat 85MM

35mm	I 7235013528
------	--------------

### Plat voorplaat 85MM

30mm	I 7235513028
------	--------------

40mm	I 7235514028
------	--------------

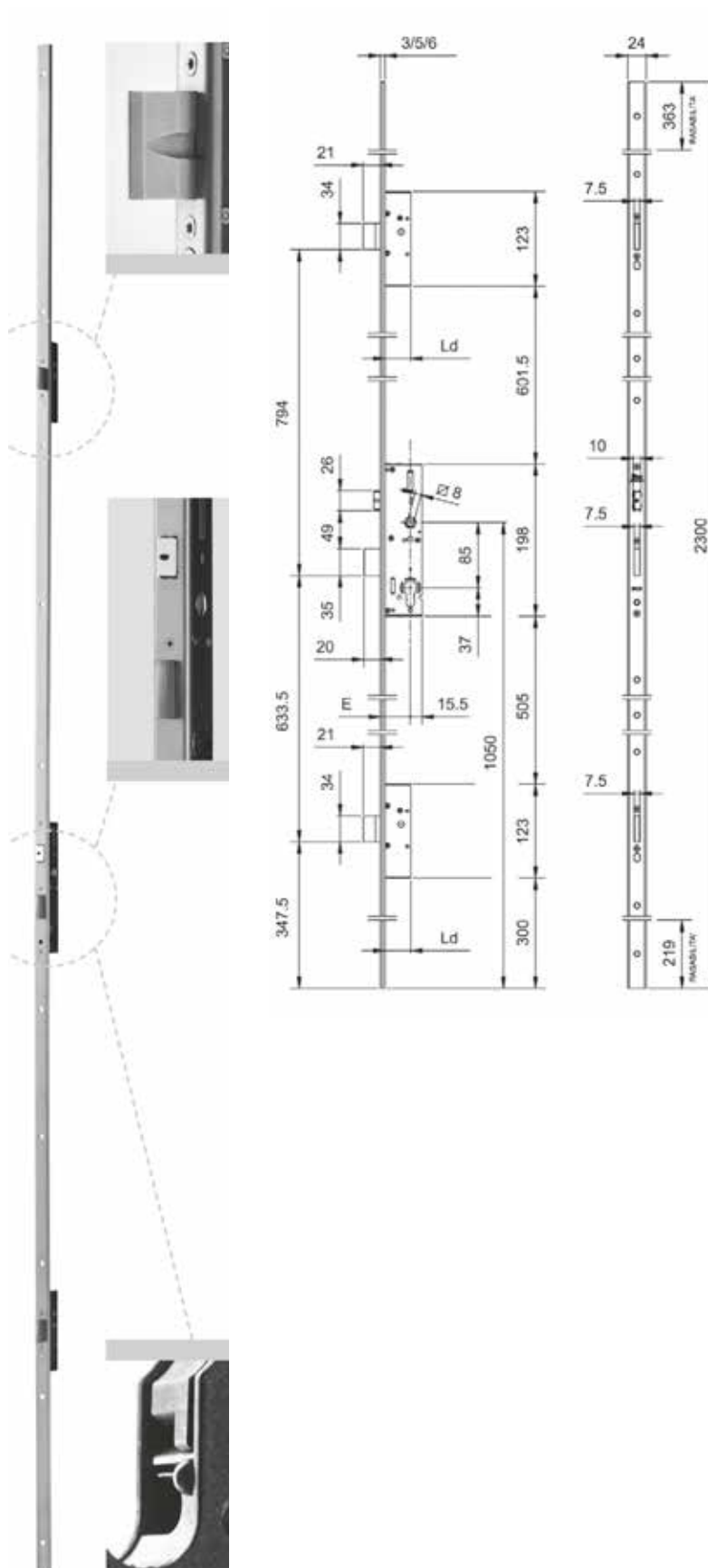

159

# Iseo Multiblindo classic

Veiligheidsvalslot

Asafstand: 92mm  
 Breedte voorplaat: 24mm  
 Type voorplaat: Plat of U-profiel  
 Materiaal voorplaat: Inox ( behalve U 22)  
 Draairichting: keerbaar  
 Kruknoot: 8mm  
 Sluiting: Dubbeltoers  
 Sluitlengte: 27mm  
 Type sleutel: Cilinder  
 Lengte voorplaat: 2300mm

Andere eigenschappen:  
 Patentgaten in hoofdslot  
 Dagschoot regelbaar of met rolknop  
 Gepantserde nachtschoot, weerstaat een zijwaartse kracht van meer dan 1000KG en 600kg Fronttake kracht.  
 Rotatiehoek: 20°  
 Gesloten slotkast  
 > 200.000 openingen onder 120N belasting

### U voorplaat 22mm

25mm	I 795150250
30mm	I 795150300
35mm	I 795150350
40mm	I 795150400

### U voorplaat 24mm

25mm	I 795100252
30mm	I 795100302
35mm	I 795100352
40mm	I 795100402

### U voorplaat 24mm 1860mm

25mm	I 795101252
30mm	I 795101302
35mm	I 795101352
40mm	I 795101402

### Platte voorplaat 24mm

25mm	I 795110252
30mm	I 795110302
35mm	I 795110352
40mm	I 795110402

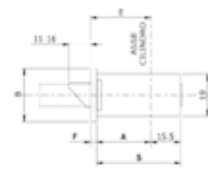
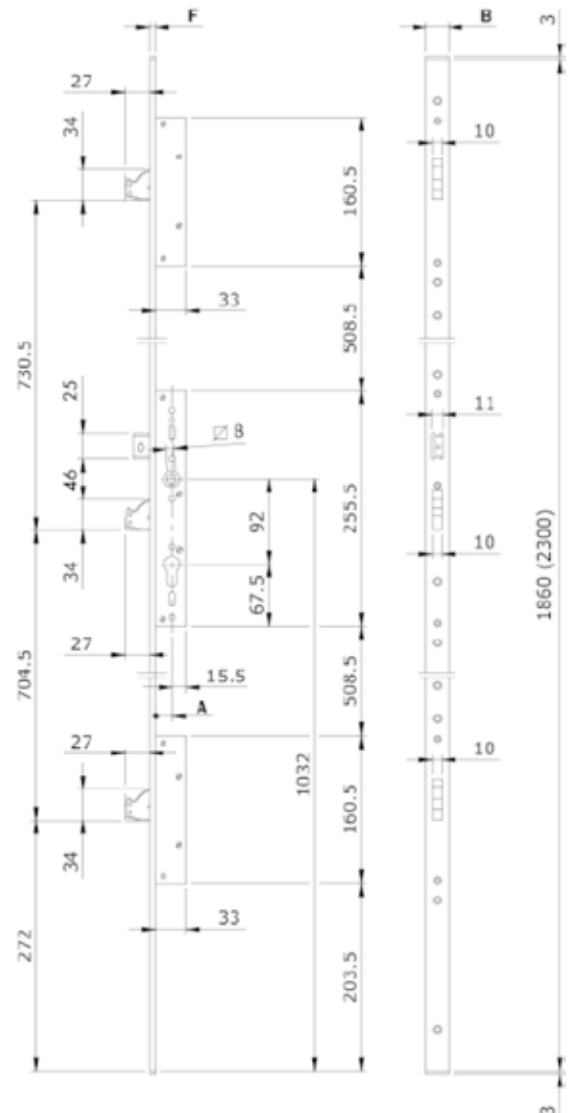

Codice						
Art	E	A	S	B	F	
79**	25	2	22	27.5	24	3
	30		27	42.5		
	35		32	47.5		
	40		37	52.5		

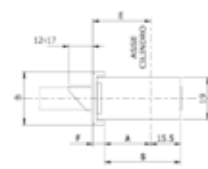

Codice						
Art	E	A	S	B	F	
79**	25	2	18	33.5	24	5
	30		23	38.5		
	35		28	43.5		
	40		33	48.5		
81	25	18	33.5			
	30		33	38.5		
	35		38	43.5		
	40		43	48.5		

your world safely locked //®



# Iseo Performa

Haak-pin meerpuntslot

Asafstand: 92mm  
 Breedte voorplaat: 24mm  
 Type voorplaat: plat of U profiel  
 Materiaal voorplaat: Inox  
 Draairichting: Keerbaar  
 Kruknoot: 8mm  
 Sluiting: Dubbeltoers  
 Sluitlengte: 20mm  
 Type sleutel: cilinder  
 Lengte voorplaat: 2300mm

Andere eigenschappen:  
 Patentgaten in het hoofdslot  
 Gesloten slotkast  
 Rotatiehoek: 20°  
 EN 12209:05  
 PR EN 15685:09  
 > 200.000 openingen onder 120N belasting

### Platte voorplaat 24mm

25mm	I 7252012528
30mm	I 7252013028
35mm	I 7252013528
40mm	I 7252014028
45mm	I 7252014528
50mm	I 7252015028
55mm	I 7252015528

### U voorplaat 24mm

30mm	I 7252513028
35mm	I 7252513528
40mm	I 7252514028
45mm	I 7252514528
50mm	I 7252515028

Rolnok	I 040940
--------	----------

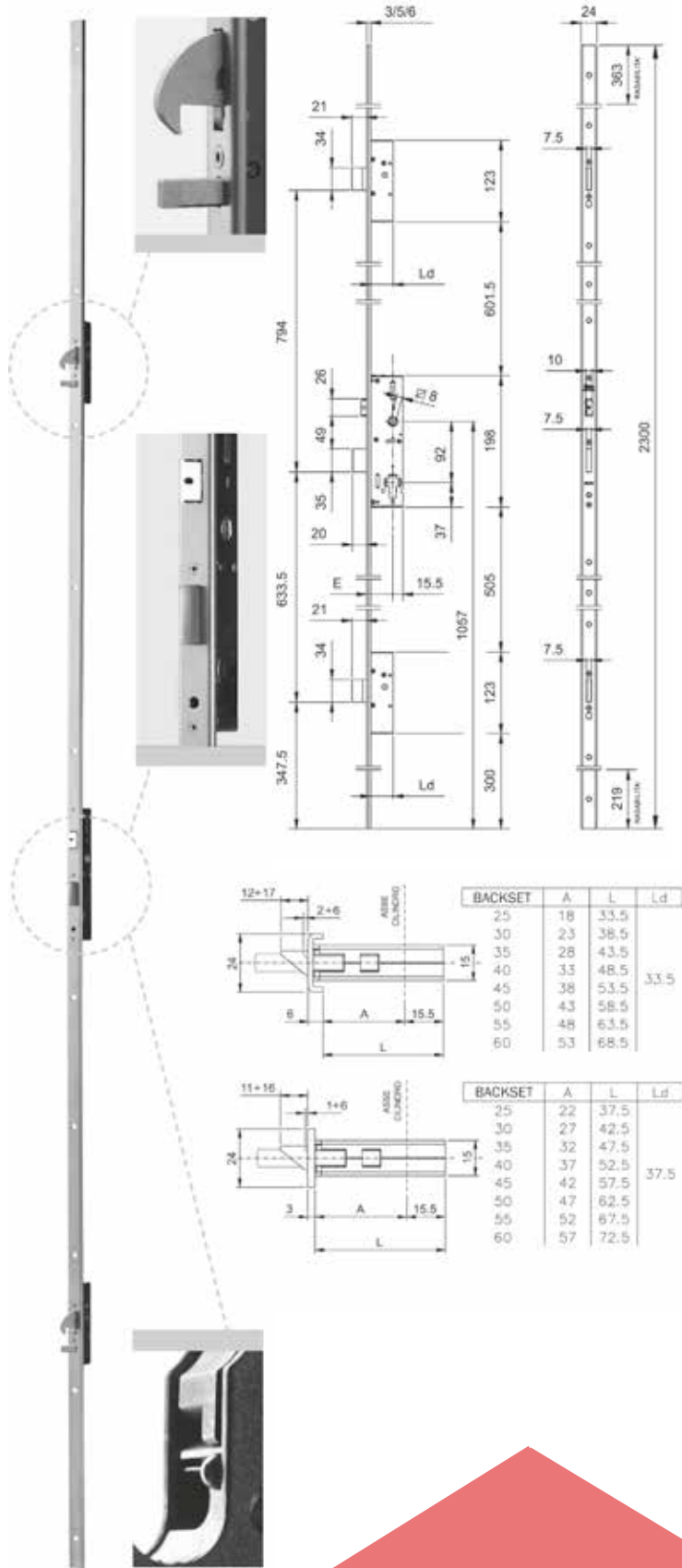

your world safely locked //®

# Iseo Performa

Meerpuntslot met rechte schieter

Asafstand: 92mm  
 Breedte voorplaat: 24mm  
 Type voorplaat: plat of U profiel  
 Materiaal voorplaat: Inox  
 Draairichting: Keerbaar  
 Kruknoot: 8mm  
 Sluiting: Dubbeltoers  
 Sluitlengte: 20mm  
 Type sleutel: cilinder  
 Lengte voorplaat: 2300mm

Andere eigenschappen:  
 Patentgaten in het hoofdslot  
 Gesloten slotkast  
 Rotatiehoek: 20°  
 EN 12209:05  
 PR EN 15685:09  
 > 200.000 openingen onder 120N belasting

### Platte voorplaat 24mm

30mm	I 7232013028
35mm	I 7232013528
50mm	I 7232015028
55mm	I 7232015528
60mm	I 7232016028

### U voorplaat 24mm

30mm	I 7232513028
35mm	I 7232513528
40mm	I 7232514028
45mm	I 7232514528
50mm	I 7232515028
55mm	I 7232515528
60mm	I 7232516028

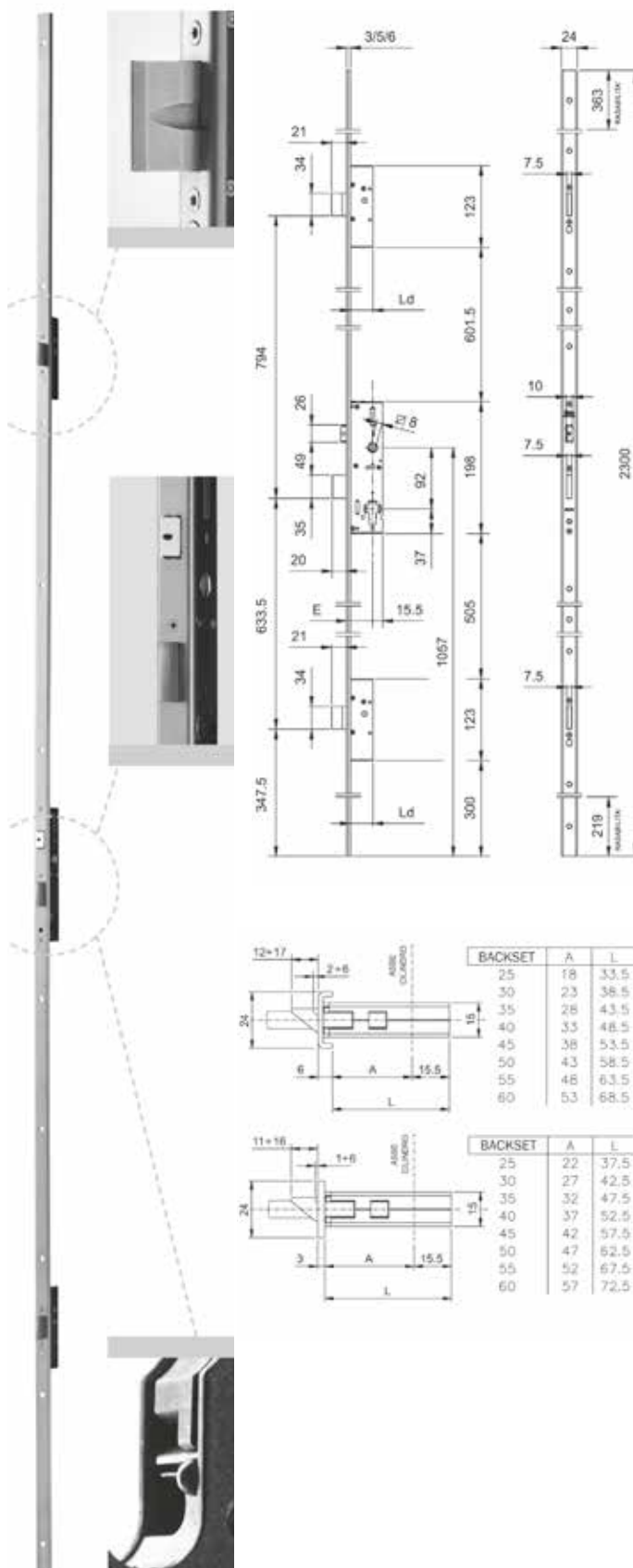

163

# Iseo Multiblindo Easy exit

Zelfvergrendelend haak/pin met anti paniekmfunctie

Asafstand: 92mm  
 Breedte voorplaat: 24mm  
 Type voorplaat: Plat of U-profiel  
 Materiaal voorplaat: Inox  
 Draairichting: niet keerbaar  
 Kruknoot: 9mm  
 Sluiting: Automatisch  
 Sluitlengte: 27mm  
 Type sleutel: cilinder  
 Lengte voorplaat: 2300mm

Andere eigenschappen:  
 Zelfvergrendelend  
 Anti paniek functie EN 1125  
 Gepantserde nachtschoot, weerstaat een zijwaartse kracht van meer dan 1000KG en 600kg frontake kracht.

- 3 verschillende sluitmogelijkheden
1. Dag/nacht automatisch ( Total)
  2. Enkel sluiting op dagschoot ( Light)
  3. Stand zonder sluiting ( free)

Voorzien van microswitch die de stand van de nachtschoten aangeeft  
 Rotatie: 31°

### U- voorplaat 24mm

35mm Din R I 7A39003522D.A

Din L I 7A39003522S.A

40mm Din R I 7A39004022D.A

Din L I 7A39004022S.A

### Platte voorplaat 24mm

35mm Din R I 7A39103522D.A

Din L I 7A39103522S.A

40mm Din R I 7A39104022D.A

Din L I 7A39104022S.A

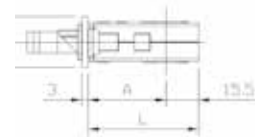
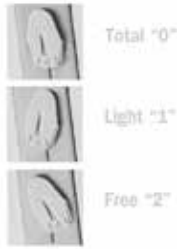
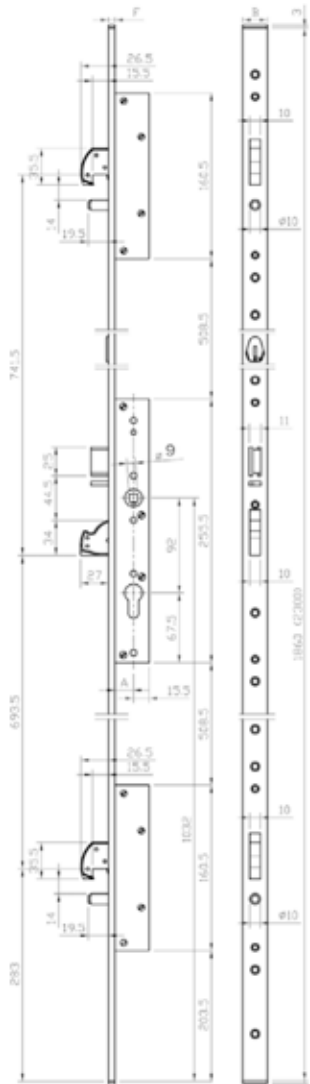

ENTRATA	A	L
35	32	47.5
40	37	52.5
45	42	57.5
50	47	62.5
55	52	67.5
60	57	72.5
65	62	77.5



ENTRATA	A	L
35	28	43.5
40	33	48.5
45	38	53.5
50	43	58.5
55	48	63.5
60	53	68.5
65	58	73.5

# Mv Meerpuntslot

meerpuntslot met pinnen

Asafstand: 92mm  
Breedte voorplaat: 16mm  
Type voorplaat: Plat  
Materiaal voorplaat: Inox  
Draairichting: keerbaar  
Kruknoot: 8mm  
Sluiting: Dubbeltoers  
Sluitlengte: 20mm  
Type sleutel: cilinder

Andere eigenschappen:  
Geschroefde slotkast  
Passende voor bestaande merken

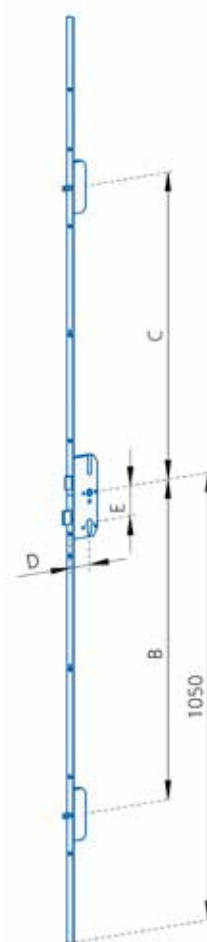

165

Voorplaat 16mm		B	C	D	E	Fit To
MV 11-44011-0008	3-PUNT PIN 92/35 VP16 730-760	760	730	35	92	KFVAS2300
MV 11-54011-0008	3-PUNT PIN 92/40 VP16 730-760	760	730	40	92	KFVAS2300
MV 11-11011-485515	3-PUNT PIN 92/40/K/16MM KORT			40	92	
MV 11-64011-0008	3-PUNT PIN 92/45 VP16 730-760	760	730	45	92	KFVAS2300
MV 11-12611-0308	3-PUNT PIN 92/55 VP16 730-760	760	730	55	92	
Voorplaat 24mm		B	C	D	E	Fit To
MV 11-47011-0009	3-PUNT PIN 92/35 U-24 730-760m	760	730	35	92	KFVAS2300
MV 11-57011-0009	3-PUNT PIN 92/40 U-24 730-760m	760	730	40	92	
MV 11-67011-0009	3-PUNT PIN 92/45 VP U24 730-760	760	730	45	92	

your world safely locked //®

Versie v1.1.2

Info@dombrecht.eu www.dombrecht.eu  
Tel: 052/44 74 84 Fax: 052/44 90 52



**Dombrecht**  
DISTRIBUTION

# Mv Meerpuntslot

meerpuntslot met rolnokken

Asafstand: 92mm  
Breedte voorplaat: 16mm  
Type voorplaat: Plat  
Materiaal voorplaat: Inox  
Draairichting: Keerbaar  
Kruknoot: 8mm  
Sluiting: Dubbeltoers  
Sluitlengte: 20mm  
Type sleutel: Cilinder

Andere eigenschappen:  
Geschroefde slotkast  
Passende voor bestaande merken

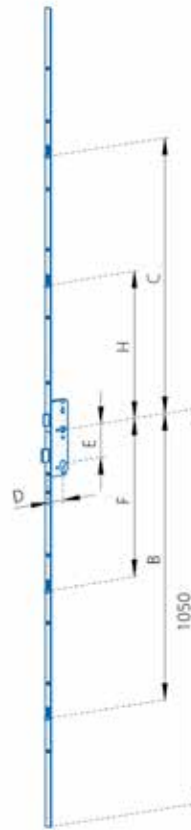

		B	C	D	E	F	H	Fit to
MV 11-46011-0308	5-PNT 2*2 ROLNOK 92/35/16 KfV	823	810	35	92	413	550	KfV AS8250
MV 11-46011-0408	5-PNT 2*2 ROLNOK 92/35/16 GU	861	749	35	92	470	470	GU V-R4
MV 11-56011-0308	5-PNT 2*2 ROLNOK 92/40/16 KfV	823	810	40	92	413	550	KfV AS8250
MV 11-66011-0308	5-PNT 2*2 ROLNOK 92/45/16 KfV	823	810	45	92	413	550	KfV AS8250

your world safely locked //®



**Dombrecht**  
DISTRIBUTION

Info@dombrecht.eu www.dombrecht.eu  
Tel: 052/44 74 84 Fax: 052/44 90 52

Versie v1.1.2

# SAB Serie 1600

Verwisselbaar hoofdslot

Asafstand: 92  
Breedte voorplaat: 16mm - 24mm  
Type voorplaat: Plat  
Materiaal voorplaat: Inox  
Draairichting: Keerbaar  
Kruknoot: 8mm  
Sluiting: Dubbeltoers  
Sluitlengte:  
Type sleutel: Porfielcilinder  
Lengte voorplaat: 2400mm

Andere eigenschappen:  
Verwisselbaar hoofdslotkast  
Slotkasten verwisselbaar in alle combinaties  
Voorplaat combineerbaar met 72mm slot

## Rolnokken

SAB 160009235ZB 5-PUNT ROLNOK 92/35 16MM

SAB 160009240ZB 5-PUNT ROLNOK 92/40 16MM

SAB 160009245ZB 5-PUNT ROLNOK 92/45 16MM

## Pinnen

SAB 166009235ZB 3-PUNT PINNEN 92/35 VP16MM

SAB 166009240ZB 3-PUNT PINNEN 92/40 VP16MM

SAB 166009245ZB 3-PUNT PINNEN 92/45 VP16MM

SAB 166009255ZB 3-PUNT PINNEN 92/55 VP16 MM

## Haken

SAB 167009235ZB 3-PUNT HAKEN 92/35 VP16MM

SAB 167009240ZB 3-PUNT HAKEN 92/40 VP16MM

SAB 167009250ZB 3-PUNT HAKEN 92/50 VP16MM

## Middenslotkast

SAB 160109235 MIDDENSLOT 92/35MM

SAB 160109240 MIDDENSLOT 92/40MM

SAB 160109245 MIDDENSLOT 92/45MM

SAB 160109250 MIDDENSLOT 92/50MM

SAB 160109255 MIDDENSLOT 92/55MM

SAB 160109265 MIDDENSLOT 92/65MM

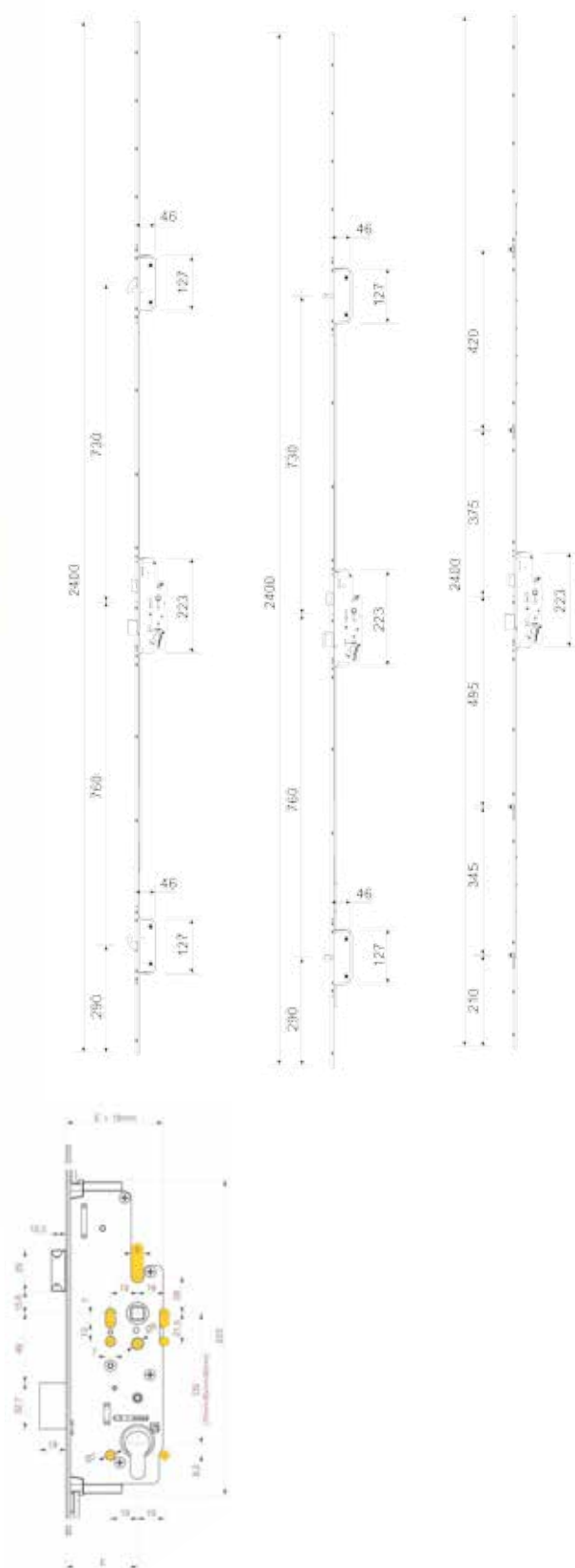

167

your world safely locked //®





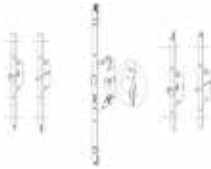

## MV Renovatie slot

3-delig met aanpasbare voorplaat

### Middenslot 16mm 92mm

MV 11-02010-1108 F16/92/65/10MM RENO

MV 11-41010-1108 F16/92/35/10MM RENO

MV 11-51010-1108 F16/92/40/10MM RENO

MV 11-61010-1108 F16/92/45/10MM RENO

MV 11-70010-1108 F16/92/50/10MM RENO

### Middenslot 18mm 92mm

MV 11-41010-1208 F18/92/35/10MM RENO

MV 11-51010-1208 F18/92/40/10MM RENO

MV 11-61010-1208 F18/92/45/10MM RENO

MV 11-70010-1208 F18/92/50/10MM RENO

### Middenslot 20mm 92mm

MV 11-41010-1308 F20/92/35/10MM RENO

MV 11-51010-1308 F20/92/40/10MM RENO

MV 11-61010-1308 F20/92/45/10MM RENO

MV 11-70010-1308 F20/92/50/10MM RENO

MV 11-02010-1308 F20/92/65/10MM RENO

### Middenslot 16mm 72mm

MV 11-01010-1108 F16/72/55/8MM RENO

MV 11-91010-1108 F16/72/65/8MM RENO

### Middenslot 18mm 72mm

MV 11-01010-1208 F18/72/55/8MM RENO

MV 11-91010-1208 F18/72/65/8MM RENO

### Middenslot 20mm 72mm

MV 11-01010-1308 F20/72/55/8MM RENO

MV 11-91010-1308 F20/72/65/8MM RENO

### Middenslot 24mm 72mm

MV 11-01010-1408 F24/72/55/8MM RENO

### Boven slot Pinnen

MV 11-01021-1108 PIN F16 MM RENO

MV 11-01021-1208 PIN F18 MM RENO

MV 11-01021-1308 PIN F20 MM RENO

### Onderslot Pinnen

MV 11-01022-1108 PIN F16 MM RENO

MV 11-01022-1208 PIN F18 MM RENO

MV 11-01022-1308 PIN F20 MM RENO

### Bovenslot Haken

MV 11-01121-1108 HAKEN F16 MM RENO

MV 11-01121-1408 HAKEN F24 MM RENO

### Onderslot Haken

MV 11-01122-1108 HAKEN F16 MM RENO

MV 11-01122-1408 HAKEN F24 MM RENO



### Performa

I 038230 TEGENPLAAT PERFORMA MID PL/24



I 038235 TEGENPL .PERFORMA MID PL/22



I 038229 TEGENPL.PERF MIDDEN PL/20 ROND



I 038220 TEGENPL.PERFORMA NACHT PL/24



I 038225 TEGENPL. PERFORMA NACHT PL/22



I 038226 TEGENPL.PERF BOV/ON PL/20 ROND



I 038722 SLUITPLAAT REGELBAAR PERFORMA ZW HAA PL/30\*203



I 038723 SLUITPLAAT REGELBAAR PERFORMA ZW HAA PL/21\*203



I 038724 SLUITPLAAT REGELBAAR PERFORMA ZW HAA PL/29\*165

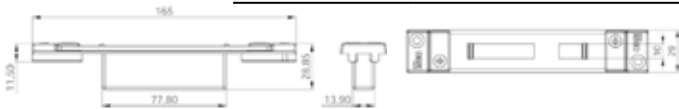

I 038720 SLUITPLAAT REGELBAAR PERFORMA ZW HAA PL/29\*186



I 038721 SLUITPLAAT REGELBAAR PERFORMA ZW HAA PL/22\*197



I 040940 ROLKNOP PERFORMA





## Iseo Meerpuntsloten onderdelen

### Multiblindo Emotion (Exit) & Easy (Exit)

I 033230 SL.PL.MULTIBL EASY MID P/DL

I 033231 SL.PL.MULTIBL EASY MID P/DR

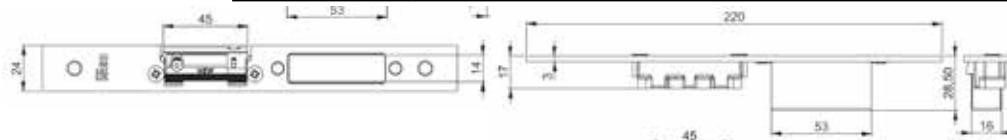

I 033232 SL.PL.MULTIBL EASY MID U/DL

I 033233 SL.PL.MULTIBL EASY MID U/DR

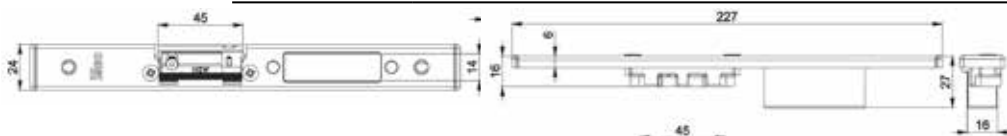

I 033240 SL.PL.EASY MID P/DL EL.OPENER DIN L

I 033241 SL.PL.EASY MID P/DR EL.OPENER DIN R

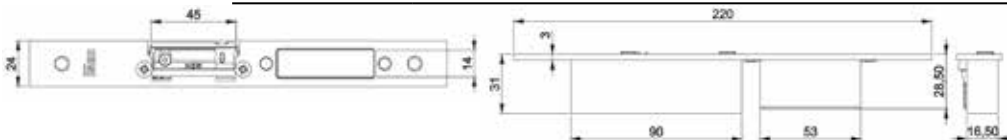

I 033242 SL.PL.EASY MID U/DL EL.OPENER DIN L

I 033243 SL.PL.EASY MID U/DR EL.OPENER DIN R

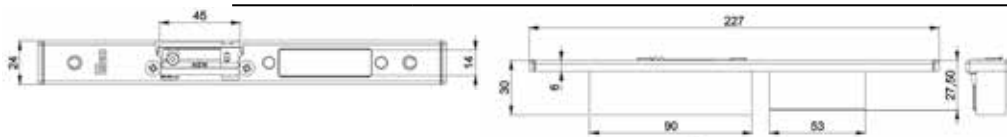

I 033165 PR SLUITPL.HAAK/PIN BOV/OND PL



I 033167 PAAR SLUITPL.HAAK/PIN BOV/OND EASY/EXIT



I 033169 SL.PL.INOX HAAK/PIN PL BOV/OND EASY/EXIT



I 033171 SLUITPL INOX HAAK/PN U BOV/OND

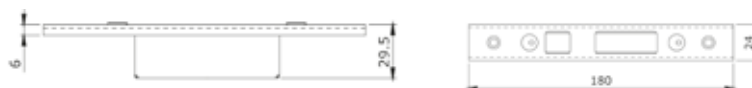

**Multiblindo Classic**

---

I 790310000 KIT ONDERSLOT MULTIBLINDO

---

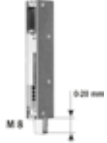

---

I 790320000 KIT BOVENSLOT MULTIBLINDO

---



---

I 790330000 KIT NACHTSLOT MULTIBLINDO

---



---

I 790340000 KIT HAAKSLOT MULTIBLINDO

---



---

I 040801 ROLKNOP - E 25

---



---

I 040802 ROLKNOP - E 30

---



---

I 040803 ROLKNOP - E 35

---



---

I 040804 ROLKNOP - E 40

---



---

I 040816 STOP DAGSCHOOT 25MM TOT 65MM

---



---

I 04080525 ANTI-INBOORPLAAT E-25 MULTIBLINDO

---



---

I 04080530 ANTI-INBOORPLAAT E-30 MULTIBLINDO

---



---

I 04080535 ANTI-INBOORPLAAT E-35 MULTIBLINDO

---



---

I 04080540 ANTI-INBOORPLAAT E-40 MULTIBLINDO

---



---

I 040806 GELEIDER + TEGENPLAATJE BOVEN

---



---

I 040807 VLOER SOKKEL

---







## Iseo Meerpuntsloten onderdelen

174

	<p>I 033168 SLUITPL.INOX VALSCH.BOV/ONDER</p>
	<p>I 033169 SL.PL.INOX HAAK/PIN PL BOV/OND</p>
	<p>I 033170 SLUITPL.INOX VALSCH.BOV/ONDER</p>
	<p>I 033171 SLUITPL INOX HAAK/PN U BOV/OND</p>
	<p>I 033173 SLUITPL.INOX MID.GESL. PL 22MM</p>
	<p>I 033174 SLUITPL. INOX MID. PL. GESL. 2</p>
	<p>I 033181 SLUITPL.INOX VALSCH.BOV/ONDER</p>
	<p>I 033182 SLUITPL.INOX HAAK/PIN BOV/OND</p>
	<p>I 038079 TEGENPLAAT GESLOTEN MIDDEN</p>
	<p>I 038083 TEGENPLAAT GESLOTEN HAAK</p>
	<p>I 038084 TEGENPLAAT GESLOTEN NACHTSCHOOT</p>
	<p>I 038085 TEGENPLAAT GESLOTEN MIDDEN</p>



## Iseo Meerpuntsloten onderdelen

I 038086 TEGENPLAAT GESLOTEN HAAK

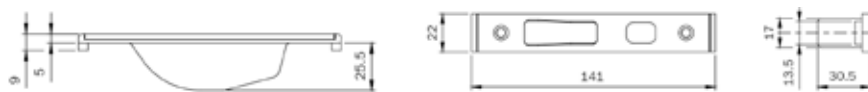

I 038087 TEGENPLAAT GESLOTEN NACHTSCHOO

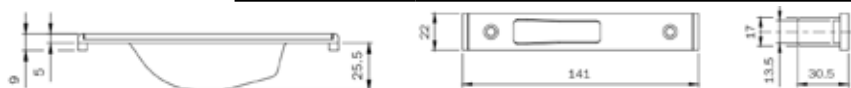

I 038088 TEGENPLAAT OPEN MIDDEN U/24

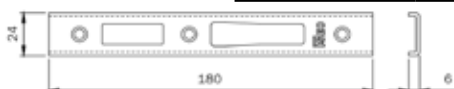

I 038089 TEGENPLAAT OPEN HAAK U/24

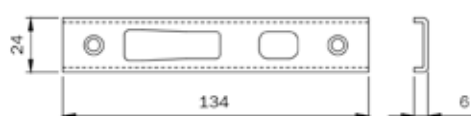

I 038090 TEGENPLAAT OPEN NACHTSCHOOT U/



I 038091 TEGENPLAAT OPEN MIDDEN U/22

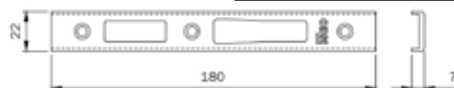

I 038092 TEGENPLAAT OPEN HAAK U/22



I 038093 TEGENPLAAT OPEN NACHTSCHOOT U/

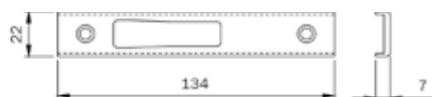

I 038094 TEGENPLAAT OPEN MIDDEN PL/24



I 038095 TEGENPLAAT OPEN HAAK PL/24

---

I 038096 TEGENPLAAT OPEN NACHTSCHOOT PL

---

I 038097 TEGENPLAAT OPEN MIDDEN PL/22

---

I 038098 TEGENPLAAT OPEN HAAK PL/22

---

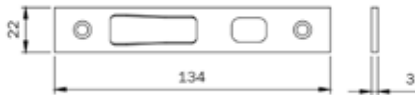
I 038099 TEGENPLAAT OPEN NACHT PL/22

---

**176**



## Iseo Meerpuntsloten onderdelen

---

### Multiblindo Classic Middenslot

---

I N9000025PC	MIDDENSLOT MULTIBLINDO 25MM
I N9000030PC	MIDDENSLOT MULTIBLINDO 30MM
I N9000035PC	MIDDENSLOT MULTIBLINDO 35MM
I N9000040PC	MIDDENSLOT MULTIBLINDO 40MM

### Multiblindo Easy (Exit) Middenslot

---

I NA000240PD	MIDDENSLOT EASY 40MM DIN R
I NA000240PS	MIDDENSLOT EASY 40MM DIN L
I NA010235PD	MIDDENSLOT EASY 35MM DIN R
I NA010235PSC	MIDDENSLOT EASY 35MM DIN L

### Multiblindo eMotion (Exit) Middenslot / motor

---

I NA013235PD.A	MIDDENSL EMOTION EXIT 35MM DIN R
I NA013235PS.A	MIDDENSL EMOTION EXIT 35MM DIN L
I 0000IS00208	MOTORBLOK MULTIBLINDO EMOTION EXIT



# Electrische Sloten



your world safely locked //®

Versie v1.1.2



**Dombrecht**  
DISTRIBUTION



**Iseo Thesis 2.0**

**182**

**182. F 0750.000.xx21**  
Solonoïde smalslot Fail secure

**183. F 0750.000.xx22**  
Solonoïde smalslot Fail safe

**Iseo Thesis 2.0 Pro**

**184**

**184. F 0760.000.xx**  
Thesis 2.0 pro

**Iseo Emotion**

**185**

**185. Iseo Multiblindo emotion**  
Elektromechanisch meerpuntslot

**186. Iseo Multiblindo emotion Exit**  
Met antipaniek functie

**187. Onderdelen en benodigdheden**  
P.171,177

**181**

your world safely locked //®

Versie v1.1.2

Info@dombrecht.eu www.dombrecht.eu  
Tel: 052/44 74 84 Fax: 052/44 90 52



**Dombrecht**  
DISTRIBUTION

# Iseo Thesis 2.0

Solenoïde smalslot Fail secure

Asafstand: 85mm  
 Breedte voorplaat: 24mm  
 Type voorplaat: plat  
 Materiaal voorplaat: Inox  
 Draairichting: keerbaar  
 Kruknoot: 8mm  
 Sluiting: Solenoïde  
 Sluitlengte: 20mm  
 Type sleutel: Cilinder  
 Lengte voorplaat: 371mm

182

### Andere eigenschappen:

Fail secure  
 Solenoïde gestuurd en controle van de functies d.m.v een microprocessor.  
 Als de deur dicht is, geeft de sensor een impuls tot automatische sluiting van de schoot  
 Diverse elektronische openingsmogelijkheden.  
 Het slot kan mechanische geopend worden, zelfs bij stroom uitval  
 Met de versie met kruknoot is er altijd een anti paniekmogelijkheid  
 Externe behuizing beschikbaar voor boven/onder montage  
 Rotatiehoek: 37°  
 Niet geschikt voor buitengebruik

### Fail secure zonder kruk

25mm	F 0750.000.2521
30mm	F 0750.000.3021
35mm	F 0750.000.3521

### Fail secure met kruk

25mm	F 0750.080.2521
30mm	F 0750.080.3021
35mm	F 0750.080.3521

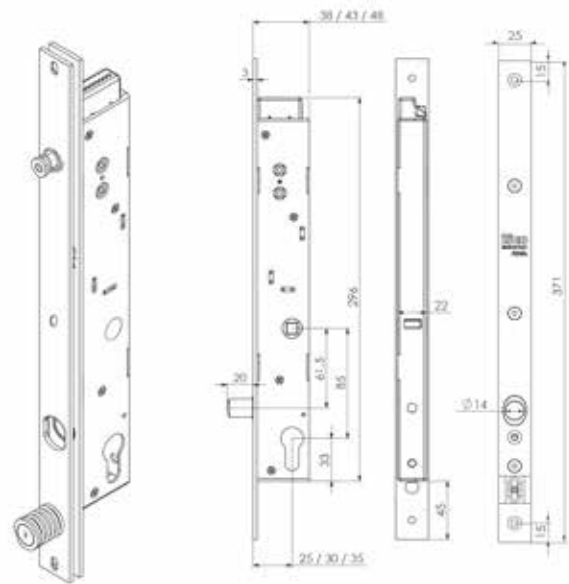
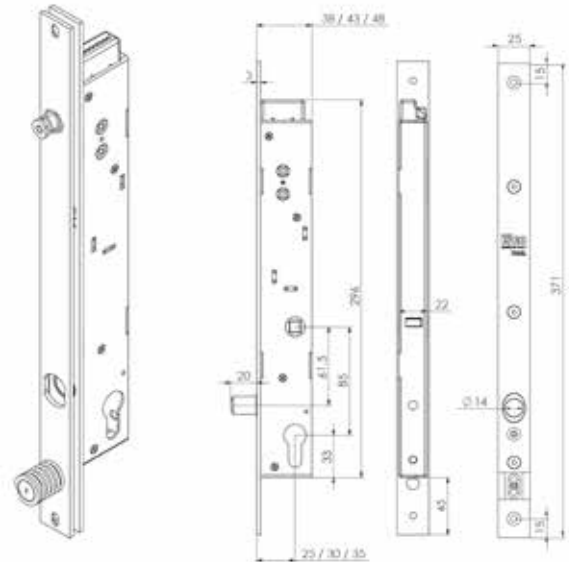

# Iseo Thesis 2.0

Solenoïde smalslot Fail Safe

Asafstand: 85mm  
 Breedte voorplaat: 24mm  
 Type voorplaat: plat  
 Materiaal voorplaat: Inox  
 Draairichting: keerbaar  
 Kruknoot: 8mm  
 Sluiting: Solenoïde  
 Sluitlengte: 20mm  
 Type sleutel: Cilinder  
 Lengte voorplaat: 371mm

### Andere eigenschappen:

Fail safe  
 Solenoïde gestuurd en controle van de functies d.m.v een microprocessor.  
 Als de deur dicht is, geeft de sensor een impuls tot automatische sluiting van de schoot  
 Diverse elektronische openingsmogelijkheden.  
 Het slot kan mechanische geopend worden, zelfs bij stroom uitval  
 Met de versie met kruknoot is er altijd een anti paniekmogelijkheid  
 Externe behuizing beschikbaar voor boven/onder montage.  
 Rotatiehoek: 37°  
 Niet geschikt voor buitengebruik

### Fail safe zonder kruk

25mm	F 0750.000.2522
30mm	F 0750.000.3022
35mm	F 0750.000.3522

### Fail safe met kruk

25mm	F 0750.080.2522
30mm	F 0750.080.3022
35mm	F 0750.080.3522

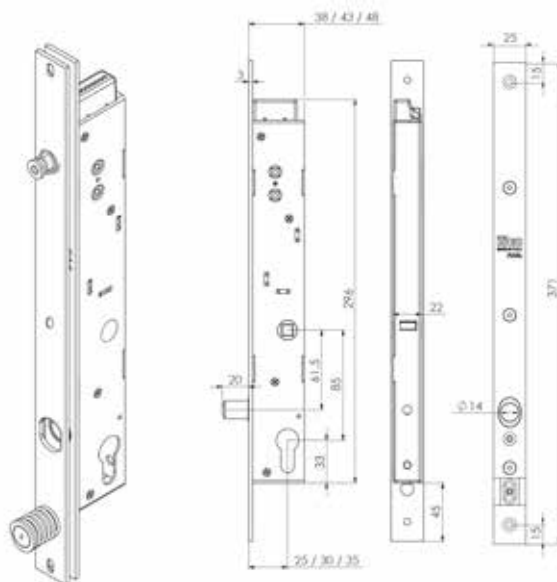
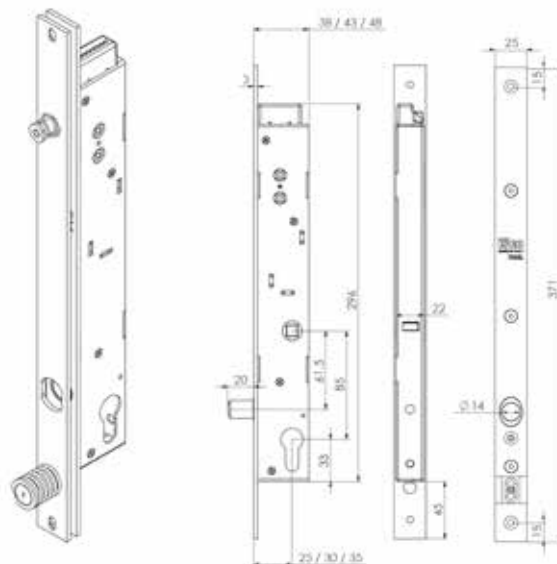

183

# Iseo Thesis 2.0 Pro

Solenoïde smalslot Fail safe

Asafstand: 85mm  
 Breedte voorplaat: 30mm  
 Type voorplaat: Hoekig  
 Materiaal voorplaat: Inox  
 Draairichting: keerbaar  
 Kruknoot: 8mm  
 Sluiting: Enkeltoers  
 Sluitlengte: 22mm  
 Type sleutel: cilinderslot  
 Lengte voorplaat: 371mm

Fail safe  
 Solenoïde gestuurd en controle van de functies d.m.v een microprocessor.  
 Als de deur dicht is, geeft de sensor een impuls tot automatische sluiting van de schoot  
 Diverse elektronische openingsmogelijkheden.  
 Het slot kan mechanische geopend worden, zelfs bij stroom uitval  
 Met de versie met kruknoot is er altijd een anti paniekmogelijkheid  
 Externe behuizing beschikbaar voor boven/onder montage.  
 Niet geschikt voor buitengebruik

**Fail secure zonder kruk**

F 07600023022 THESIS 2.0 PRO 30MM F. SAFE

**Fail secure met kruk**

F 07600823022 THESIS 2.0 PRO 30MM/8 F. SAFE

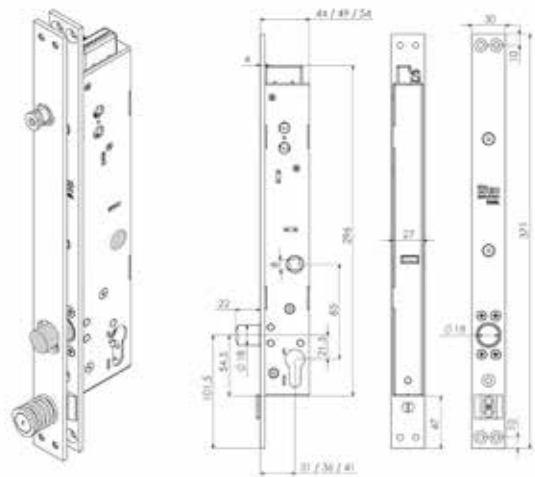
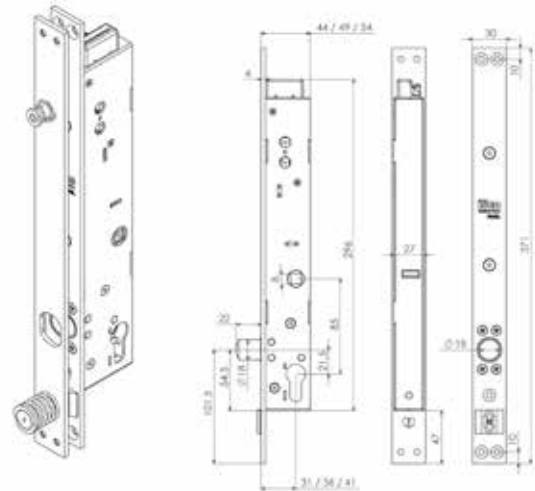

# Iseo Multiblindo eMotion

elektromechanisch meerpuntslot

Asafstand: 92mm  
 Breedte voorplaat: 24mm  
 Type voorplaat: plat of U-profiel  
 Materiaal voorplaat: Inox  
 Draairichting: niet keerbaar  
 Kruknoot: 8mm  
 Sluiting: Electromechanische  
 Sluitlengte: 27mm

Elektromechanisch meerpuntslot 12v DC met haak en pin.  
 Mechanische sluiting ( via 3 verschillende standen)  
 Gemotoriseerde opening  
 Rotatiehoek: 39°  
 Sleutelbediening aan binnen en buitenzijde mogelijk  
 Diverse elektronische openingsmogelijkheden  
 EN14846 PR EN 15685  
 Geleverd met connectie kabel  
 Akoestische open- of sluitsignalen die door de gebruiker  
 desgewenst kunnen uitgeschakeld worden.  
 Multiblindo eMotion garandeert de hoogste graad van  
 inbraakveiligheid: geen verlies van instellingen bij stroomuit-  
 val, en in noodgevallen kan men steeds overschakelen naar  
 mechanisch sleutelgebruik

### Platte voorplaat 24mm

35mm	Din R	I 7A3610352.D
	Din L	I 7A3610352.S
40mm	Din R	I 7A3610402.D
	Din L	I 7A3610402.S

### U- voorplaat 24mm

35mm	Din R	I 7A3600352.D
	Din L	I 7A3600352.S
40mm	Din R	I 7A3600402.D
	Din L	I 7A3600402.S

### Middenslot

35mm	Din R	I NA600235PD
	Din L	I NA600235PS
40mm	Din R	I NA600240PD
	Din L	I NA600240PS

AANSLUITINGSKABEL 6M  
 I KE01730C

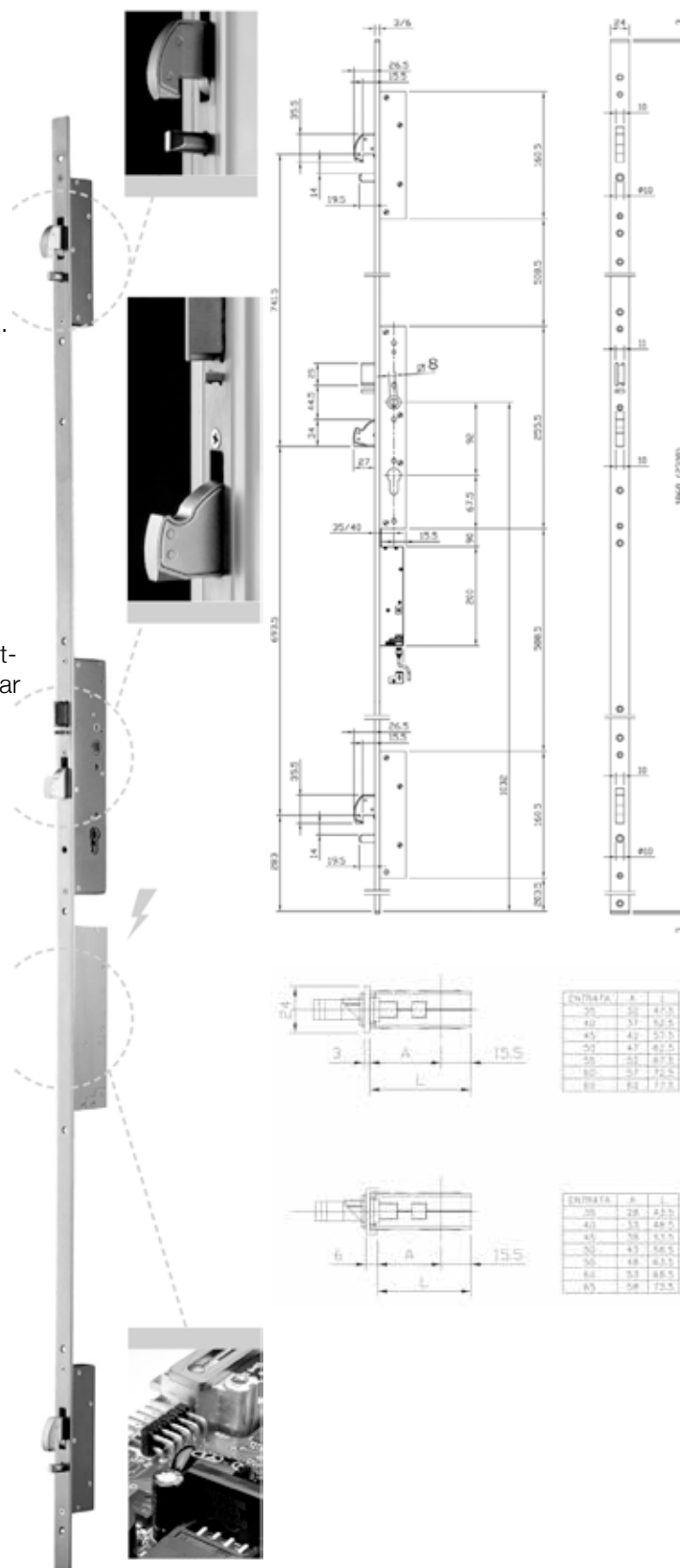

185

your world safely locked //®

# Iseo Multiblindo eMotion exit

Elektromechanisch meerpuntslot met anti paniek functie

Asafstand: 92mm  
 Breedte voorplaat: 24mm  
 Type voorplaat: plat of U-profiel  
 Materiaal voorplaat: inox  
 Draairichting: Niet keerbaar  
 Kruknoot: 9mm  
 Sluiting: Automechanisch  
 Sluitlengte: 27mm

186

Elektromechanisch meerpuntslot 12v DC met haak en pin.  
 Mechanische sluiting ( via 3 verschillende standen)  
 Gemotoriseerde opening  
 Rotatiehoek: 39°  
 Sleutelbediening aan binnen en buitenzijde mogelijk  
 Diverse elektronische openingsmogelijkheden  
 EN14846  
 PR EN 15685  
 Geleverd met connectie kabel  
 Akoestische open- of sluitsignalen die door de gebruiker  
 desgewenst kunnen uitgeschakeld worden.  
 Anti-paniek EN1125 conform  
 Voorzien van een microswitch die de stand van de  
 nachtshoten aangeeft.  
 Multiblindo eMotion garandeert de hoogste graad van  
 inbraakveiligheid: geen verlies van instellingen bij stroomuit-  
 val, en in noodgevallen kan men steeds overschakelen naar  
 mechanisch sleutelgebruik

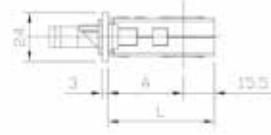
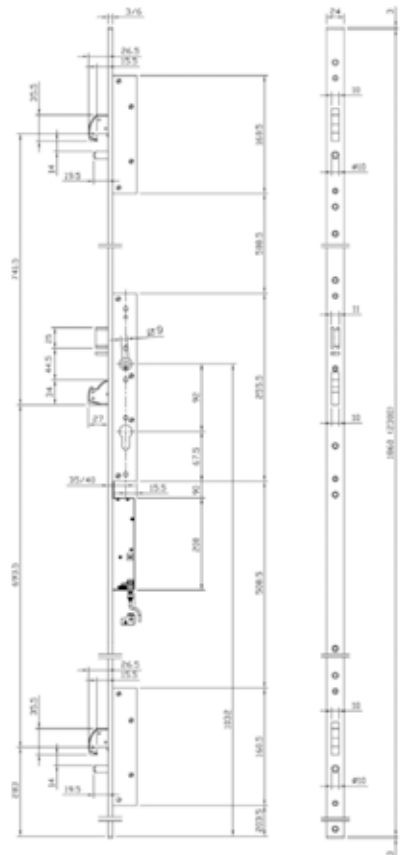
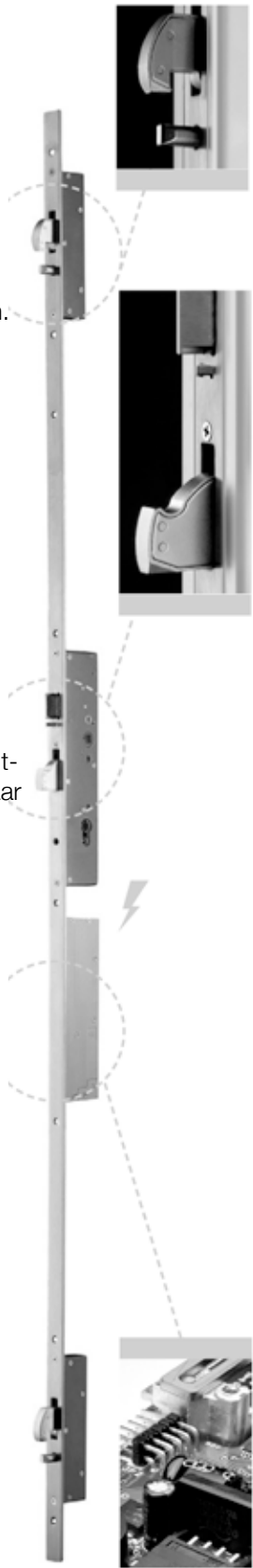

EXMATA	A	L
35	35	437.5
40	38	437.5
45	41	437.5
50	47	437.5
55	52	437.5
60	57	437.5
65	62	437.5

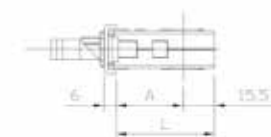

EXMATA	A	L
35	38	437.5
40	41	437.5
45	46	437.5
50	47	437.5
55	49	437.5
60	51	437.5
65	54	437.5

Platte voorplaat 24mm		
35mm	Din R	I 7A37103521D.A
	Din L	I 7A37103521S.A
40mm	Din R	I 7A37104021D.A
	Din L	I 7A37104021S.A
U- voorplaat 24mm		
35mm	Din R	I 7A37003521D.A
	Din L	I 7A37003521S.A
40mm	Din R	I 7A37004021D.A
	Din L	I 7A37004021S.A
Middenslot		
35mm	Din R	I NA013235PD.A
	Din L	I NA013235PS.A
Aansluitkabel 6m		
		I KE01730C



## Iseo Multiblindo eMotion onderdelen



I 94403000E VOEDING 230V AC - 12V DC - 3A



I 94403010E KABELGELEIDER EXT 300 MM



I 94403110E KABELGELEIDER INT 300 MM



I 94A000050698 PRO EXIT VR EM- EX 92MM 8/35°

I 94A000050699 PRO EXIT VR EM- EX 92MM 9/35°

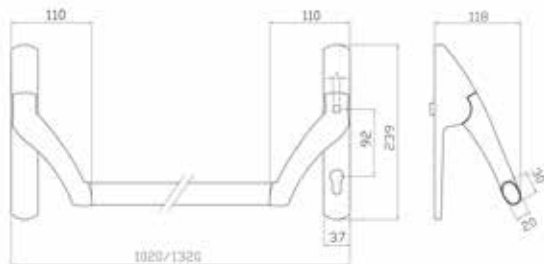



# Electrische Deuropeners



your world safely locked //®

Versie v1.1.2



**Dombrecht**  
DISTRIBUTION

# Definitie van Deuropeners

Algemene Instructies



Corriente alterna (AC)

Wisselspanning

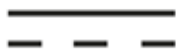

Corriente continua (dc)

Gelijkspanning



Grendel (D)

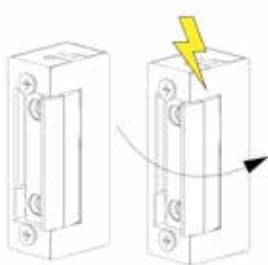

Standaard functie (N)

De deur is ontgrendeld zolang er spanning op de sluitplaat staat ( arbeidstroom). De opening van de deur moet gebeuren TIJDENS de impuls

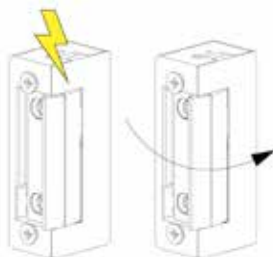

Failsafe (500)

Ruststroom

De deur is ontgrendeld zolang de spanning op de sluitplaat wordt onderbroken ( ruststroom).  
N512 betekend 12VDC  
N524 betekend 24VDC

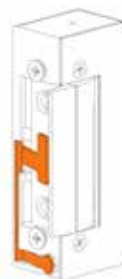

Microswicht (305)

deze versie heeft een ingebouwde microscharrelaar met NO / NC-contactinformatie als de deur open of gesloten, dan kan een beveiligings- of toegangscontrolesysteem deze informatie gebruiken.

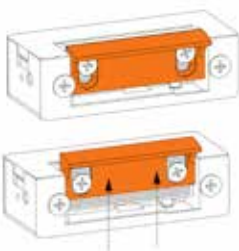

regelbare schootvanger (F)

your world safely locked //®



**Dombrecht**  
DISTRIBUTION

Info@dombrecht.eu www.dombrecht.eu  
Tel: 052/44 74 84 Fax: 052/44 90 52

Versie v1.1.2

## Iseo Deuropeners

# 192

### 192. I 5651830

Met inox voorplaat

### 192. I 5611850

Met gelakte voorplaat

### 192. I 5661900

Met voorplaat - keerbaar

### 193. I 040XXX

zonder voorplaat

### 194. I 03319X

voorplaten

## Dorcas deuropeners

# 195

### 195. Serie 54

Fit for Effeff 117-127-137

### 196. Serie 99

Fit to Effeff 118-128-138

### 197. Serie 62

Waterbestendig IP65

### 198. Serie 50

Weerstand 1000kg

### 198. Serie 77n500

Voor nooduitgangen

### 199. Serie 56

speciaal voor mindervalide personen

### 199. Serie CII

Voor glasdeuren

191







## Iseo deuropeners zonder voorplaat



I 040030 6-12v, Na impluls, met grendel

I 040070 24v, Na impluls, met grendel



I 040040 6-12v, Na impluls, zonder grendel

I 040080 24v, Na impluls, zonder grendel



I 040010 6-12v, tijdens impluls, met grendel

I 040050 24v, tijdens impluls, met grendel



I 040020 6-12v, tijdens impluls, zonder grendel

I 040060 24v, tijdens impluls, zonder grendel



I 040100 12v, Fail safe zonder grendel

I 040110 24v, Fail safe zonder grendel

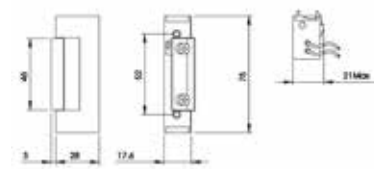
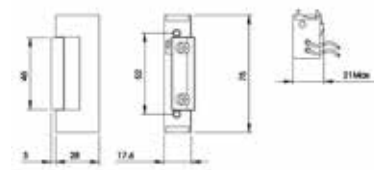
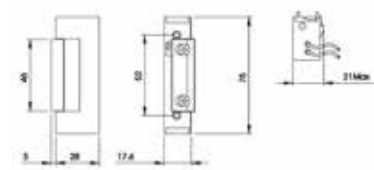
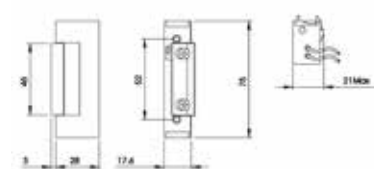



194



I 033190 VRPL.EL.DEUROP.IN PL KEER VALS

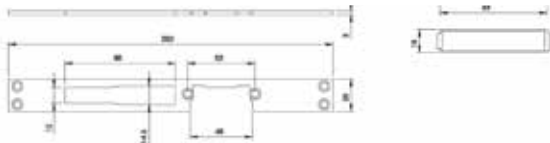

I 033194 VOORPL.EL.DEUROP.INOX U DIN LI

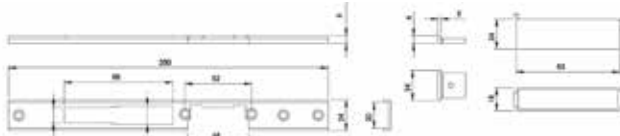

I 033195 VOORPL.EL.DEUROP.INOX U DIN RE

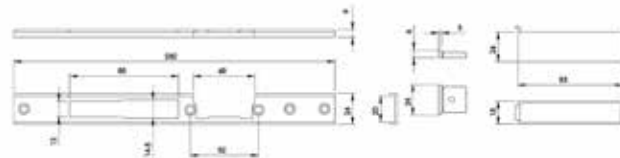

I 033191 HOEKPLAAT GELAKT EL.OPENER DL

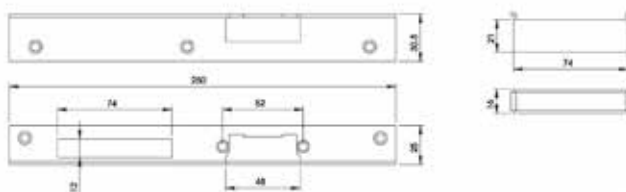

I 033192 HOEKPLAAT GELAKT EL.OPENER DR

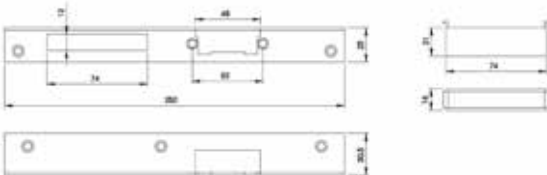

I 033193 VRPL.EL.DEUROP.IN PL KEE NACHT

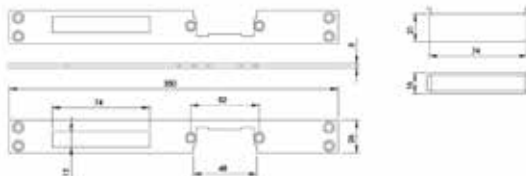

I 033196 VRPL.EL.DEUROP.IN PL.KEER DAGS

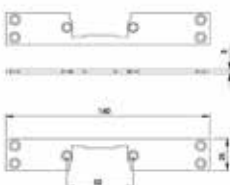

# Dorcac Serie 54

Fit to Effeff

## Serie 54

Fit to Effeff 117-127-137  
 Symetrisch slotkast  
 Radiaal draaiende schootvanger  
 Meest universele model  
 regelbare schootvanger  
 Kracht 3250N

DOR 54A FLEX	6-12V NA IMP.
DOR 54AD FLEX	6-12V NA IMP. BLOK
DOR 54N FLEX	6-12V TIJDENS IMP.
DOR 54N412 FLEX	12V TIJD.IMP. BL Z GRENDEL
DOR 54N512 FLEX	12V RUSTSTROOM
DOR 54N524 FLEX	24V RUSTSTROOM
DOR 54ND FLEX	6-12V TIJDENS IMP. BLOK
DOR 54ND412 FLEX	12V TIJD.IMP. BL.,180mA
DOR 54ND424 FLEX	24V TIJD.IMP. BL.,180mA
Sluitplaat	
DOR LX	Sluitplaat voor Elec. Opener

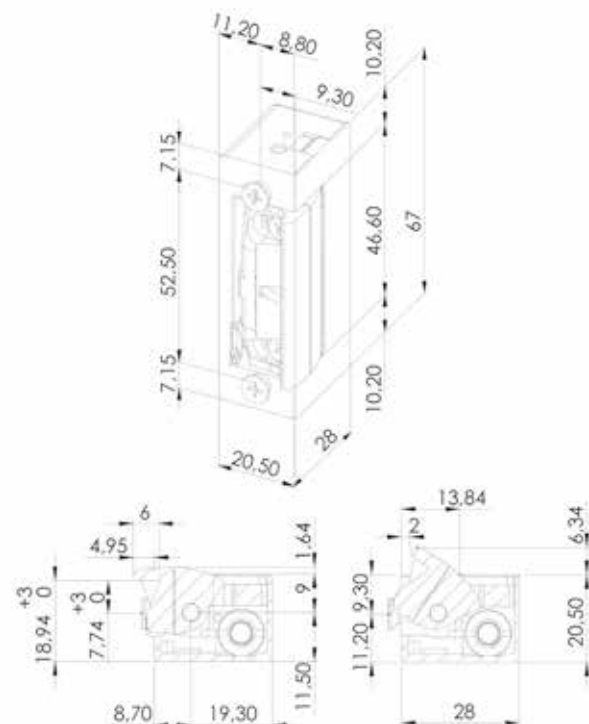
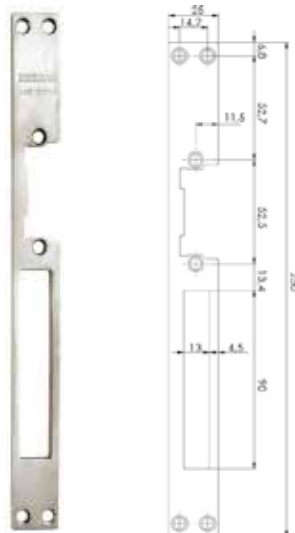

**195**

your world safely locked //®

# Dorcac Serie 99

Fit to Effeff

## Serie 99

Fit to Effeff 118-128-138  
 Symetrische slotkast  
 Radiaal draaiende schootvanger  
 Multivoltage  
 Slechts 25,5mm diepte  
 AD/DC  
 Kracht 3230N

196

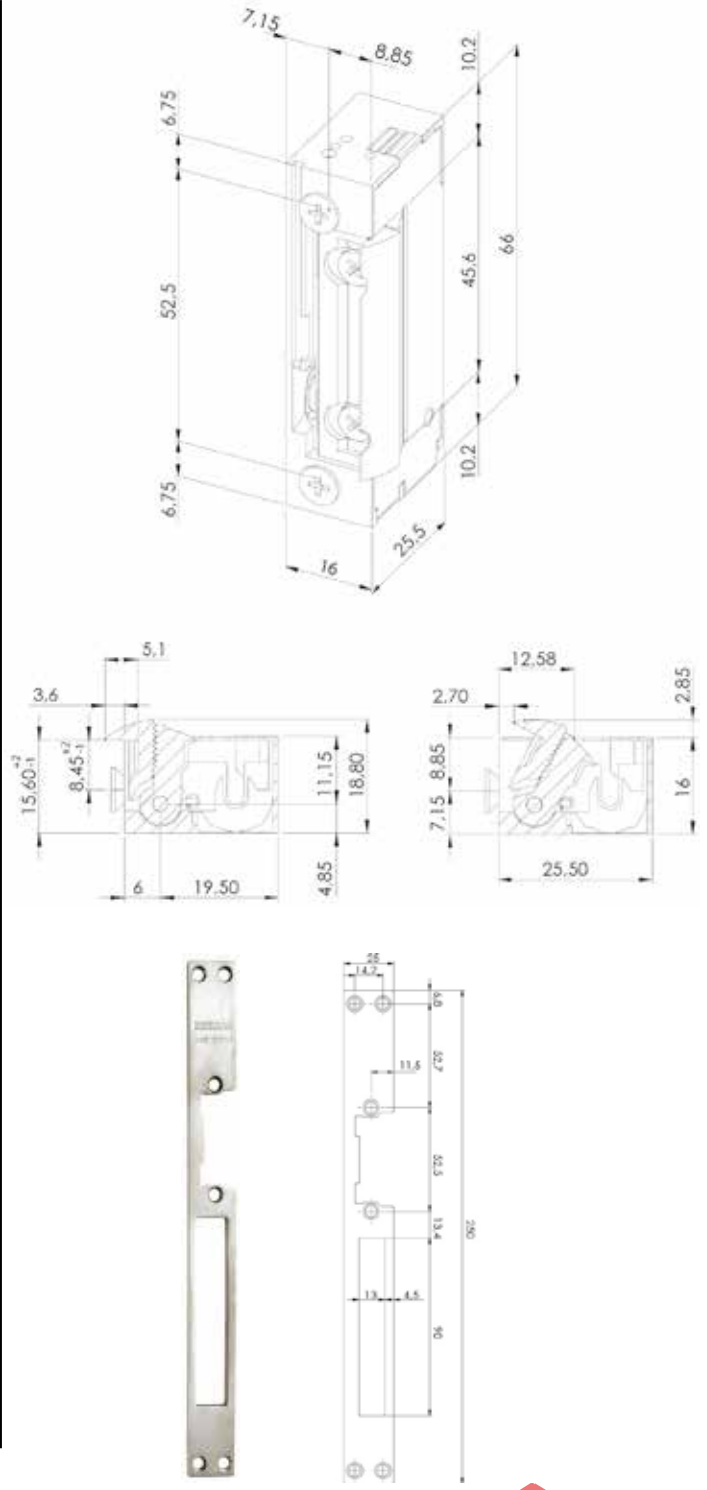
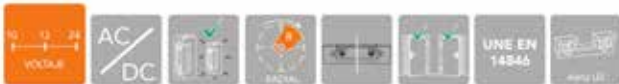

DOR 99-1 AF TOP	10-24V MET GREND INBOUW
DOR 99-1 N305F TOP	10-24V TIJD.IMP. TOP MICRO
DOR 99-2 ADF	10-24V NA IMPULS IMP.GREND
DOR 99-2 N305-512F	12V FAIL SAFE VDC MET MICROSCHWITCH
DOR 99-2 N305-524F	24V FAIL SAFE VDC MET MICROSCHWITCH
DOR 99-2 N305F	12-24 FAIL SECURE VDC MET MICROSCHWITCH
DOR 99-2 N512F	12V FAIL SAFE VDC
DOR 99-2 N524F	24V FAIL SAFE VDC
DOR 99-2 NDF	10-24V TIJDENS IMP.GREND
DOR 99-2 NF	10-24V TIJDENS IMPULS
	Sluitplaat
DOR LX	Sluitplaat voor Elec. Opener

# Dorcas Serie 62

Water bestendig

## Serie 62

Waterbestendig IP65  
 Beschikt voor buitengebruik  
 Niet keerbaar  
 Kracht: 3900N

Ideaal voor poorten en hekken



DOR 62AAD DIN LEFT	IP 65,12V NA IMP. BLOK
DOR 62AAD DIN RIGHT	IP 65,12V NA IMP. BLOK
DOR 62AAD-24VDC DL	IP 65,24V NA IMP. BLOK
DOR 62AAD-24VDC DR	IP 65,24V NA IMP. BLOK
	Sluitplaat
DOR LX	Sluitplaat voor Elec. Opener

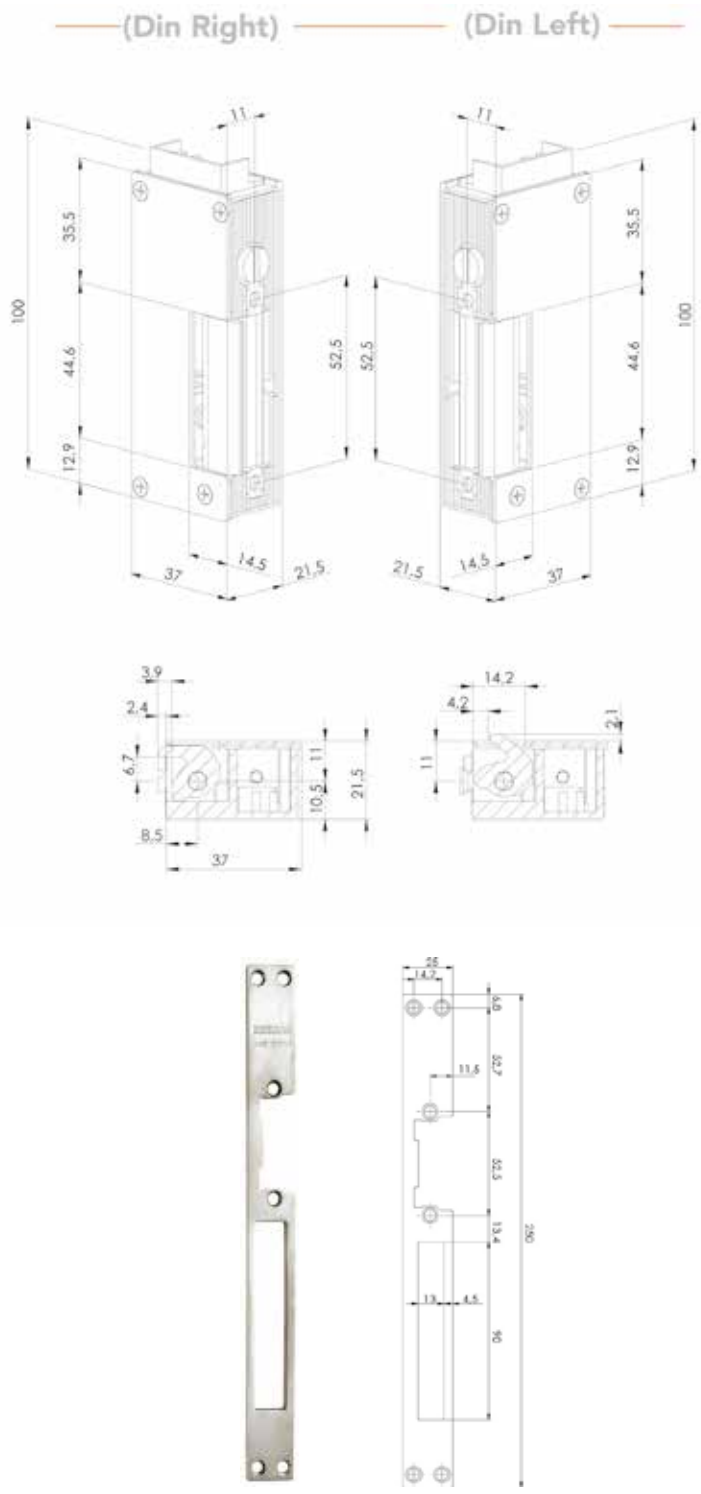

197

# Dorcac Serie 50 - 77N500

Weerstand aan zware lasten

## Serie 50

Weerstand 7800N - 800KG

Symmetrisch

Staalschoot

Ideaal voor zware en stevige deuren

Regelbare schootvanger

DOR 50N 305-424 24V VDC MICROSWITCH

DOR 50N 305-424FLEX 24V VDC MICRO/KEER/REGEL

DOR 50N 305-512FLEX 12V FAIL SAFE MIC/KE/RE

DOR 50N 305-524FLAC 24V FAIL SAFE MIC/KE/RE

DOR 50N 305-524FLEX 24V FAIL SAFE MIC/KE/RE

DOR 50N305FLEX 8-12V MICRO/KEER/REGELB

Sluitplaat

DOR LX Sluitplaat voor Elec. Opener

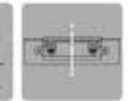
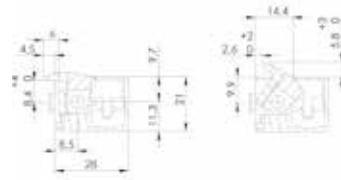
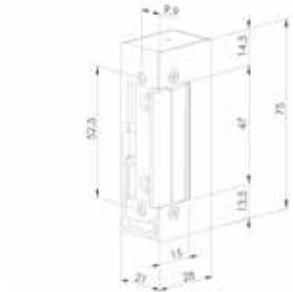

## Serie 77n500

Deuropener voor nooduitgangen

Preload: 4000n

Resistentie 1300kg

Microswitch

DOR 77N305-524F DL

DOR 77N305-524F DR

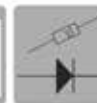
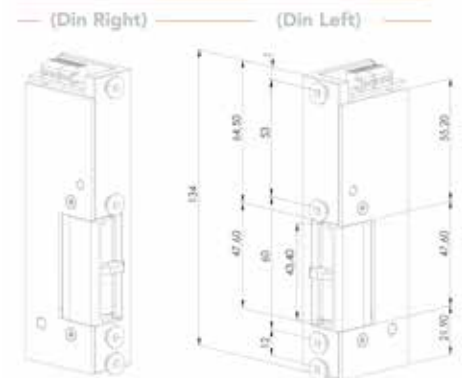

your world safely locked //®

198





# Veiligheidsbeslag



your world safely locked //®

Versie v1.1.2



**Dombrecht**  
DISTRIBUTION

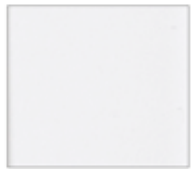

F1

Alu

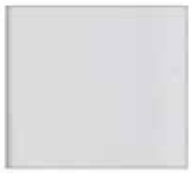

F2

Champagne



F3

Koper



F4

Brons

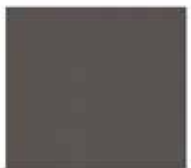

F5

Bruin



F9

Inox Look

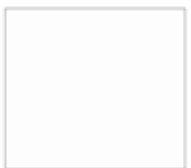

F12

Wit ( Ral 9016)



F14

Zwart (RAL9010)



K 11



K 2



K 1



K 7



K 8



ODL: Ohne Drückerlock  
Zonder kruk gat  
BE : Beide zijde voor ODL/OSL  
( op aanvraag)



OSL: Ohne Schüssellock  
Zonder sleutel gat  
BE : Beide zijde voor ODL/OSL  
( op aanvraag)



Blind:  
zonder kruk gat en sleutel gat  
( op aanvraag)

**Alpha reeks**  
Breed beslag hoekig

205

- 207. D 7003  
Zonder kernbeveiliging Kruk - Kruk
- 207. D 7001  
Zonder kernbeveiliging Knop - Kruk
- 208. D 7001/1303  
Draaibare kruk zonder kernbeveiliging
- 209. D 7029  
Zonder kernbeveiliging Greep - Kruk
- 210. D 7009/K8  
Breede greep zonder kernbeveiliging
- 212. D 7013  
Met kernbeveiliging kruk - Kruk
- 214. D 7011  
Met kernbeveiliging Knop - Kruk
- 215. D 7019  
Met kernbeveiliging Knop - Kruk
- 216. D 7018/K8  
Met kernbeveiliging Greep - Kruk

**Rombus reeks**  
Breed beslag afgerond

217

- 218. D 7021/03  
Zonder kernbeveiliging kruk - Kruk
- 218. D 7021/02  
Zonder kernbeveiliging Greep - Kruk
- 219. D 7022/03  
Met kernbeveiliging Kruk - Kruk
- 219. D 7022/02  
Met kernbeveiliging Greep - Kruk

**Kronos reeks**  
Smalbeslag afgerond

220

- 221. D 1300/0035  
zonder kernbeveiliging Kruk - Kruk
- 222. D 1300/K2/2035  
zonder kernbeveiliging Greep - Kruk
- 223. D 1300/0045  
Met kernbeveiliging Kruk - Kruk
- 224. D 1300/K2/2045  
Met kernbeveiliging Greep - kruk

**Pan reeks**  
Smalbeslag hoekig

225

- 226. D 320  
Zonder kernbeveiliging Kruk - Kruk
- 226. D 312  
Zonder kernbeveiliging Greep - Kruk

203

**228. D 8905**

Smalrozet zonder kernbeveiliging

**228. D 890020**

Smalrozet met kernbeveiliging

**229. D 6533**

Veiligheidsrozet zonder kernbeveiliging

**230. D 7554**

Veiligheidsrozet onzichtbare vijzen

**230. D 7156**

Veiligheidsrozet met kernbeveiliging

**231. SAB 304**

Veiligheidsrozet met kernbeveiliging

**232. D 817 & D811**

Kleefrozetten

**233. D 290**

Binnenschild met patentgaten

**235. D Rolladendrpr**

Rolluikkrukkenpaar

**234. D 323**

Binnenschild voor D 8905- 890020

**235. D 1003**

Vensterkrukken afsluitbaar

**235. D 1002**

Verstevigde vensterkruk

**236. D 125**

Krukkenpaar

**237. D 237**

Langschilden

**239. Andere rozetten en krukken**

WC rozet, binnenrozetten, knoppen, kruk rozetten

# Dieckmann Alpha

## Veiligheidsbeslag voor houten deuren

Buitschilddikte 12mm  
 Breedte : 52mm  
 Binnenschild dikte 6mm  
 Volle alu platen  
 3 staalgeharte nokken  
 Antiboorplaatjes in de nokken  
 Staalplaat rond de cilinder  
 SKG \*\*\*

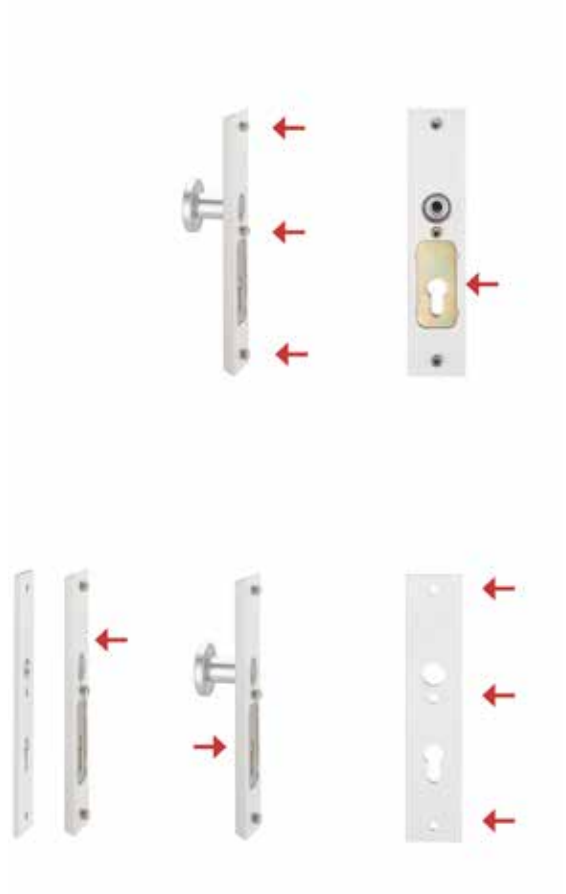

205

your world safely locked //®

Versie v1.1.2

Info@dombrecht.eu www.dombrecht.eu  
 Tel: 052/44 74 84 Fax: 052/44 90 52



**Dombrecht**  
 DISTRIBUTION



**Dieckmann D 7003**

Zonder kernbescherming  
Kruk-Kruk



Schild dikte: 12mm buiten, 6mm binnen  
Breedte: 52mm  
3 staalgeharte nokken  
Antiboortplaatjes in de nokken  
Staalplaat rond de cilinder  
Ook beschikbaar op 70mm

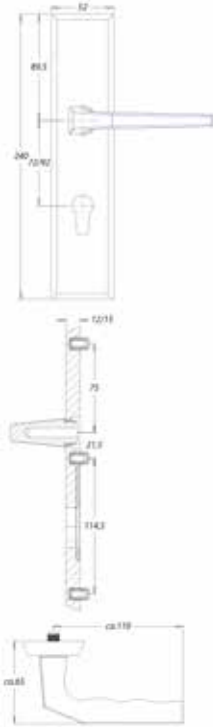

F1	72D 7003/72/8/F1	ALPHA KR-KR 72/F1
	85D 7003/85/8/F1	ALPHA KR-KR 85/F1
	92D 7003/92/8/F1	ALPHA KR-KR 92/F1
	110D 7003/110/8/F1	ALPHA KR-KR 110/F1
F2	72D 7003/72/8/F2	ALPHA KR-KR 72/F2
	85D 7003/85/8/F2	ALPHA KR-KR 85/F2
	92D 7003/92/8/F2	ALPHA KR-KR 92/F2
	110D 7003/110/8/F2	ALPHA KR-KR 110/F2
F3	72D 7003/72/8/F3	ALPHA KR-KR 72/F3
	85D 7003/85/8/F3	ALPHA KR-KR 85/F3
	92D 7003/92/8/F3	ALPHA KR-KR 92/F3
	110D 7003/110/8/F3	ALPHA KR-KR 110/F3
F4	72D 7003/72/8/F4	ALPHA KR-KR 72/F4
	85D 7003/85/8/F4	ALPHA KR-KR 85/F4
	92D 7003/92/8/F4	ALPHA KR-KR 92/F4
	110D 7003/110/8/F4	ALPHA KR-KR 110/F4
F5	72D 7003/72/8/F5	ALPHA KR-KR 72/F5
	85D 7003/85/8/F5	ALPHA KR-KR 85/F5
	92D 7003/92/8/F5	ALPHA KR-KR 92/F5
	110D 7003/110/8/F5	ALPHA KR-KR 110/F5
F9	72D 7003/72/8/F9	ALPHA KR-KR 72/F9
	85D 7003/85/8/F9	ALPHA KR-KR 85/F9
	92D 7003/92/8/F9	ALPHA KR-KR 92/F9
	110D 7003/110/8/F9	ALPHA KR-KR 110/F9
F12	55D 7003/55/8/F12	ALPHA KR-KR 55/F12
	72D 7003/72/8/F12	ALPHA KR-KR 72/F12
	85D 7003/85/8/F12	ALPHA KR-KR 85/F12
	92D 7003/92/8/F12	ALPHA KR-KR 92/F12
	110D 7003/110/8/F12	ALPHA KR-KR 110/F12
F14	72D 7003/72/8/F14	ALPHA KR-KR 72/F14
	85D 7003/85/8/F14	ALPHA KR-KR 85/F14
	92D 7003/92/8/F14	ALPHA KR-KR 92/F14
	110D 7003/110/8/F14	ALPHA KR-KR 110/F14

206



**Dieckmann D 7001**  
Zonder kernbescherming  
Knop-Kruk



Schild dikte: 12mm buiten, 6mm binnen  
Breedte: 52mm  
3 staalgeharte nokken  
Antiboortplaatjes in de nokken  
Staalplaat rond de cilinder

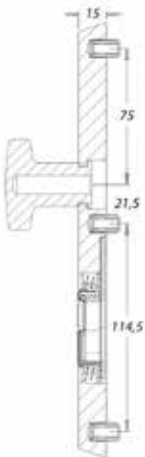
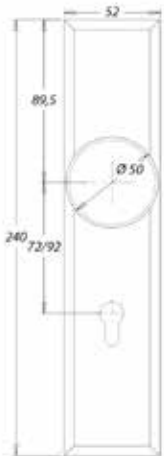

F1	55 D 7001/55/8/F1	ALPHA KN-KR 55/F1
	72 D 7001/72/8/F1	ALPHA KN-KR 72/F1
	85 D 7001/85/8/F1	ALPHA KN-KR 85/F1
	92 D 7001/92/8/F1	ALPHA KN-KR 92/F1
	110 D 7001/110/8/F1	ALPHA KN-KR 110/F1
F2	55 D 7001/55/8/F2	ALPHA KN-KR 55/F2
	72 D 7001/72/8/F2	ALPHA KN-KR 72/F2
	85 D 7001/85/8/F2	ALPHA KN-KR 85/F2
	92 D 7001/92/8/F2	ALPHA KN-KR 92/F2
	110 D 7001/110/8/F2	ALPHA KN-KR 110/F2
F3	72 D 7001/72/8/F3	ALPHA KN-KR 72/F3
	85 D 7001/85/8/F3	ALPHA KN-KR 85/F3
	92 D 7001/92/8/F3	ALPHA KN-KR 92/F3
	110 D 7001/110/8/F3	ALPHA KN-KR 110/F3
F4	72 D 7001/72/8/F4	ALPHA KN-KR 72/F4
	85 D 7001/85/8/F4	ALPHA KN-KR 85/F4
	92 D 7001/92/8/F4	ALPHA KN-KR 92/F4
	110 D 7001/110/8/F4	ALPHA KN-KR 110/F4
F5	55 D 7001/55/8/F5	ALPHA KN-KR 55/F5
	72 D 7001/72/8/F5	ALPHA KN-KR 72/F5
	85 D 7001/85/8/F5	ALPHA KN-KR 85/F5
	92 D 7001/92/8/F5	ALPHA KN-KR 92/F5
F12	72 D 7001/72/8/F12	ALPHA KN-KR 72/F12
	85 D 7001/85/8/F12	ALPHA KN-KR 85/F12
	92 D 7001/92/8/F12	ALPHA KN-KR 92/F12
	110 D 7001/110/8/F12	ALPHA KN-KR 110/F12
F14	72 D 7001/72/8/F14	ALPHA KN-KR 72/F14
	85 D 7001/85/8/F14	ALPHA KN-KR 85/F14
	92 D 7001/92/8/F14	ALPHA KN-KR 92/F14
	110 D 7001/110/8/F14	ALPHA KN-KR 110/F14





**Dieckmann D 7001/1303**  
 Zonder kernbescherming  
 Draaibare knop-Kruk

Schild dikte: 12mm buiten, 6mm binnen  
 Breedte: 52mm  
 3 staalgeharte nokken  
 Antiboorplaatjes in de nokken  
 Staalplaat rond de cilinder  
 Draaibare knop

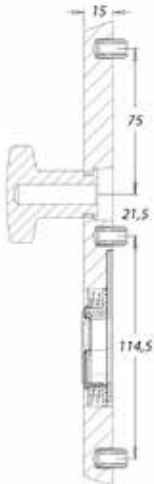
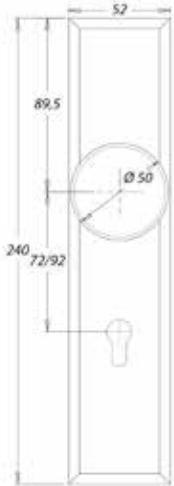

F1	70	D 7001-1303/70/F1	ALPHA KN-KR 70/F1
	72	D 7001-1303/72/F1	ALPHA KN-KR 72/F1
	85	D 7001-1303/85/F1	ALPHA KN-KR 85/F1
	92	D 7001-1303/92/F1	ALPHA KN-KR 92/F1
	110	D 7001-1303/110/F1	ALPHA KN-KR 110/F1
F2	70	D 7001-1303/70/F2	ALPHA KN-KR 70/F2
	72	D 7001-1303/72/F2	ALPHA KN-KR 72/F2
	85	D 7001-1303/85/F2	ALPHA KN-KR 85/F2
	92	D 7001-1303/92/F2	ALPHA KN-KR 92/F2
	110	D 7001-1303/110/F2	ALPHA KN-KR 110/F2
F3	70	D 7001-1303/70/F3	ALPHA KN-KR 70/F3
	72	D 7001-1303/72/F3	ALPHA KN-KR 72/F3
	85	D 7001-1303/85/F3	ALPHA KN-KR 85/F3
	92	D 7001-1303/92/F3	ALPHA KN-KR 92/F3
	110	D 7001-1303/110/F3	ALPHA KN-KR 110/F3
F4	70	D 7001-1303/70/F4	ALPHA KN-KR 70/F4
	72	D 7001-1303/72/F4	ALPHA KN-KR 72/F4
	85	D 7001-1303/85/F4	ALPHA KN-KR 85/F4
	92	D 7001-1303/92/F4	ALPHA KN-KR 92/F4
	110	D 7001-1303/110/F4	ALPHA KN-KR 110/F4
F5	70	D 7001-1303/70/F5	ALPHA KN-KR 70/F5
	72	D 7001-1303/72/F5	ALPHA KN-KR 72/F5
	85	D 7001-1303/85/F5	ALPHA KN-KR 85/F5
	92	D 7001-1303/92/F5	ALPHA KN-KR 92/F5
	110	D 7001-1303/110/F5	ALPHA KN-KR 110/F5
F12	72	D 7001-1303/72/F12	ALPHA KN-KR 72/F12
	85	D 7001-1303/85/F12	ALPHA KN-KR 85/F12
	92	D 7001-1303/92/F12	ALPHA KN-KR 92/F12
	110	D 7001-1303/110/F12	ALPHA KN-KR 110/F12

208



**Dieckmann D 7029**  
 Zonder kernbescherming  
 Greep-Kruk

Schild dikte: 12mm buiten, 6mm binnen  
 Breedte : 52mm  
 3 staalgeharte nokken  
 Antiboorplaatjes in de nokken  
 Staalplaat rond de cilinder

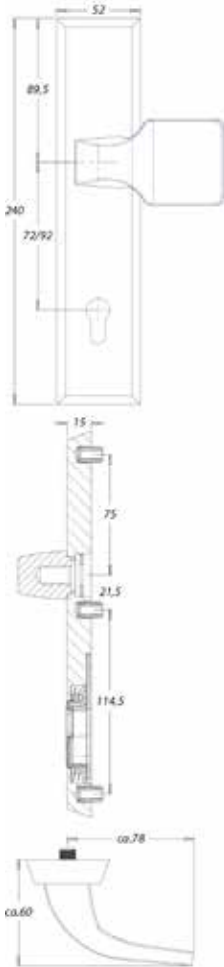

F1	72D 7029/72/8/F1	ALPHA GR-KR 72/F1
	85D 7029/85/8/F1	ALPHA GR-KR 85/F1
	92D 7029/92/8/F1	ALPHA GR-KR 92/F1
F2	110D 7029/110/F1	ALPHA GR-KR 110/F1
	72D 7029/72/8/F2	ALPHA GR-KR 72/F2
	85D 7029/85/8/F2	ALPHA GR-KR 85/F2
F4	92D 7029/92/8/F2	ALPHA GR-KR 92/F2
	72D 7029/72/8/F4	ALPHA GR-KR 72/F4
	85D 7029/85/8/F4	ALPHA GR-KR 85/F4
F5	110D 7029/110/F4	ALPHA GR-KR 110/F4
	72D 7029/72/8/F5	ALPHA GR-KR 72/F5
	110D 7029/110/F5	ALPHA GR-KR 110/F5
F9	72D 7029/72/8/F9	ALPHA GR-KR 72/F9
	85D 7029/85/8/F9	ALPHA GR-KR 85/F9
	92D 7029/92/8/F9	ALPHA GR-KR 92/F9
	110D 7029/110/F9	ALPHA GR-KR 110/F9
F12	92D 7029/92/F12	ALPHA GR-KR 92/F12





**Dieckmann D 7009/K8**   
 Zonder kernbescherming  
 Greep-Kruk

Schild dikte: 12mm buiten, 6mm binnen  
 Breedte : 52mm  
 3 staalgeharte nokken  
 Antiboorplaatjes in de nokken  
 Staalplaat rond de cilinder

F1	55D 7009/K8/55/F1	ALPHA GR-KR 55/F1
	70D 7009/K8/70/F1	ALPHA GR-KR 70/F1
	72D 7009/K8/72/F1	ALPHA GR-KR 72/F1
	85D 7009/K8/85/F1	ALPHA GR-KR 85/F1
	92D 7009/K8/92/F1	ALPHA GR-KR 92/F1
F2	110D 7009/K8/110/F1	ALPHA GR-KR 110/F1
	70D 7009/K8/70/F2	ALPHA GR-KR 70/F2
	72D 7009/K8/72/F2	ALPHA GR-KR 72/F2
	85D 7009/K8/85/F2	ALPHA GR-KR 85/F2
	92D 7009/K8/92/F2	ALPHA GR-KR 92/F2
F3	110D 7009/K8/110/F2	ALPHA GR-KR 110/F2
	55D 7009/K8/55/F3	ALPHA GR-KR 55/F3
	70D 7009/K8/70/F3	ALPHA GR-KR 70/F3
	72D 7009/K8/72/F3	ALPHA GR-KR 72/F3
	85D 7009/K8/85/F3	ALPHA GR-KR 85/F3
F4	92D 7009/K8/92/F3	ALPHA GR-KR 92/F3
	110D 7009/K8/110/F3	ALPHA GR-KR 110/F3
	72D 7009/K8/72/F4	ALPHA GR-KR 72/F4
	85D 7009/K8/85/F4	ALPHA GR-KR 85/F4
	92D 7009/K8/92/F4	ALPHA GR-KR 92/F4
F5	110D 7009/K8/110/F4	ALPHA GR-KR 110/F4
	70D 7009/K8/70/F5	ALPHA GR-KR 70/F5
	72D 7009/K8/72/F5	ALPHA GR-KR 72/F5
	85D 7009/K8/85/F5	ALPHA GR-KR 85/F5
	92D 7009/K8/92/F5	ALPHA GR-KR 92/F5
	110D 7009/K8/110/F5	ALPHA GR-KR 110/F5

210

**Dieckmann D 7009/K8**

Zonder kernbescherming  
Greep-Kruk

Schild dikte: 12mm buiten, 6mm binnen

Breedte : 52mm

3 staalgeharte nokken

Antiboorplaatjes in de nokken

Staalplaat rond de cilinder

F9	72D 7009/K8/72/F9	ALPHA GR-KR 72/F9
	85D 7009/K8/85/F9	ALPHA GR-KR 85/F9
	92D 7009/K8/92/F9	ALPHA GR-KR 92/F9
	110D 7009/K8/110/F9	ALPHA GR-KR 110/F9
F12	72D 7009/K8/72/F12	ALPHA GR-KR 72/F12
	110D 7009/K8/110/F12	ALPHA GR-KR 110/F12
F14	85D 7009/K8/85/F14	ALPHA GR-KR 85/F14
	92D 7009/K8/92/F14	ALPHA GR-KR 92/F14
	110D 7009/K8/110/14	ALPHA GR-KR 110/F14



**Dieckmann D 7013**

Met kernbescherming  
Kruk-Kruk

Schild dikte: 15mm buiten, 6mm binnen  
Breedte : 52mm  
Cilinderoverstand: 12-18mm  
3 staalgeharte nokken  
Antiboorplaatjes in de nokken  
Staalplaat rond de cilinder

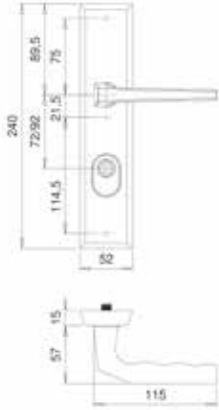

F1	55D 7013/55/8/F1	ALPHA KR-KR 55/F1 KB
	72D 7013/72/8/F1	ALPHA KR-KR 72/F1 KB
	85D 7013/85/8/F1	ALPHA KR-KR 85/F1 KB
	92D 7013/92/8/F1	ALPHA KR-KR 92/F1 KB
	110D 7013/110/8/F1	ALPHA KR-KR 110/F1 KB
F2	55D 7013/55/8/F2	ALPHA KR-KR 55/F2 KB
	72D 7013/72/8/F2	ALPHA KR-KR 72/F2 KB
	85D 7013/85/8/F2	ALPHA KR-KR 85/F2 KB
	92D 7013/92/8/F2	ALPHA KR-KR 92/F2 KB
	110D 7013/110/8/F2	ALPHA KR-KR 110/F2 KB
F3	72D 7013/72/8/F3	ALPHA KR-KR 72/F3 KB
	85D 7013/85/8/F3	ALPHA KR-KR 85/F3 KB
	92D 7013/92/8/F3	ALPHA KR-KR 92/F3 KB
	110D 7013/110/8/F3	ALPHA KR-KR 110/F3 KB
F4	72D 7013/72/8/F4	ALPHA KR-KR 72/F4 KB
	85D 7013/85/8/F4	ALPHA KR-KR 85/F4 KB
	92D 7013/92/8/F4	ALPHA KR-KR 92/F4 KB
	110D 7013/110/8/F4	ALPHA KR-KR 110/F4 KB
F5	72D 7013/72/8/F5	ALPHA KR-KR 72/F5 KB
	85D 7013/85/8/F5	ALPHA KR-KR 85/F5 KB
	92D 7013/92/8/F5	ALPHA KR-KR 92/F5 KB

212



**Dieckmann D 7013**

Met kernbescherming  
Kruk-Kruk



Schild dikte: 15mm buiten, 6mm binnen  
Breedte : 52mm  
Cilinderoverstand: 12-18mm  
3 staalgeharte nokken  
Antiboorplaatjes in de nokken  
Staalplaat rond de cilinder

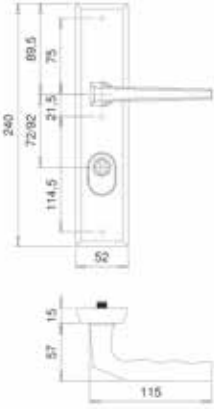

F9	72D 7013/72/8/F9	ALPHA KR-KR 72/F9 KB
	85D 7013/85/8/F9	ALPHA KR-KR 85/F9 KB
	92D 7013/92/8/F9	ALPHA KR-KR 92/F9 KB
F12	110D 7013/110/8/F9	ALPHA KR-KR 110/F9 KB
	72D 7013/72/8/F12	ALPHA KR-KR 72/F12 KB
	85D 7013/85/8/F12	ALPHA KR-KR 85/F12 KB
F14	92D 7013/92/8/F12	ALPHA KR-KR 92/F12 KB
	110D 7013/110/8/F12	ALPHA KR-KR 110/F12 KB
	72D 7013/72/8/F14	ALPHA KR-KR 72/F14 KB
	85D 7013/85/8/F14	ALPHA KR-KR 85/F14 KB
	92D 7013/92/8/F14	ALPHA KR-KR 92/F14 KB





## Dieckmann D 7011

Met kernbescherming  
Knop-Kruk

Schild dikte: 15mm buiten, 6mm binnen  
Breedte : 52mm  
Cilinderoverstand 12-18mm  
3 staalgeharte nokken  
Antiboorplaatjes in de nokken  
Staalplaat rond de cilinder



F1	72D 7011/72/8/F1	ALPHA KN-KR 72/F1 KB
	85D 7011/85/8/F1	ALPHA KN-KR 85/F1 KB
	92D 7011/92/8/F1	ALPHA KN-KR 92/F1 KB
	110D 7011/110/8/F1	ALPHA KN-KR 110/F1 KB
F2	72D 7011/72/8/F2	ALPHA KN-KR 72/F2 KB
	85D 7011/85/8/F2	ALPHA KN-KR 85/F2 KB
	92D 7011/92/8/F2	ALPHA KN-KR 92/F2 KB
	110D 7011/110/8/F2	ALPHA KN-KR 110/F2 KB
F3	72D 7011/72/8/F3	ALPHA KN-KR 72/F3 KB
	85D 7011/85/8/F3	ALPHA KN-KR 85/F3 KB
	92D 7011/92/8/F3	ALPHA KN-KR 92/F3 KB
	110D 7011/110/8/F3	ALPHA KN-KR 110/F3 KB
F4	72D 7011/72/8/F4	ALPHA KN-KR 72/F4 KB
	85D 7011/85/8/F4	ALPHA KN-KR 85/F4 KB
	92D 7011/92/8/F4	ALPHA KN-KR 92/F4 KB
	110D 7011/110/8/F4	ALPHA KN-KR 110/F4 KB
F5	72D 7011/72/8/F5	ALPHA KN-KR 72/F5 KB
	85D 7011/85/8/F5	ALPHA KN-KR 85/F5 KB
	92D 7011/92/8/F5	ALPHA KN-KR 92/F5 KB
	110D 7011/110/8/F5	ALPHA KN-KR 110/F5 KB
F12	72D 7011/72/8/F12	ALPHA KN-KR 72/F12 KB
	85D 7011/85/8/F12	ALPHA KN-KR 85/F12 KB
	92D 7011/92/8/F12	ALPHA KN-KR 92/F12 KB
	110D 7011/110/8/F12	ALPHA KN-KR 110/F12 KB

214

**Dieckmann D 7019**

Met kernbescherming  
Greep-Kruk

Schild dikte: 15mm buiten, 6mm binnen  
Breedte : 52mm  
Cilinderoverstand: 12-18mm  
3 staalgeharte nokken  
Antiboorplaatjes in de nokken  
Staalplaat rond de cilinder

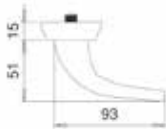
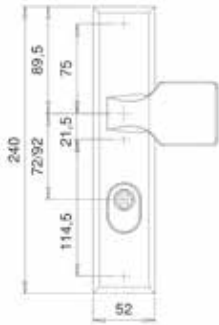

F1	72D 7019/72/F1
	85D 7019/85/F1
	92D 7019/92/F1
	110D 7019/110/F1
F2	72D 7019/72/F2
	85D 7019/85/F2
	92D 7019/92/F2
	110D 7019/110/F2
F3	72D 7019/72/F3
	85D 7019/85/F3
	92D 7019/92/F3
	110D 7019/110/F3
F4	72D 7019/72/F4
	85D 7019/85/F4
	92D 7019/92/F4
	110D 7019/110/F4
F5	72D 7019/72/F5
	85D 7019/85/F5
	92D 7019/92/F5
	110D 7019/110/F5
F9	72D 7019/72/F9
	85D 7019/85/F9
	92D 7019/92/F9
	110D 7019/110/F9
F12	72D 7019/72/F12
	85D 7019/85/F12
	92D 7019/92/F12
	110D 7019/110/F12
F14	110D 7019/110/F14





**Dieckmann D 7012/K8**

Met kernbescherming  
Greep-Kruk

Schild dikte: 15mm buiten, 6mm binnen  
Breedte : 52mm  
Cilinderoverstand: 12-18mm  
3 staalgeharte nokken  
Antiboorplaatjes in de nokken  
Staalplaat rond de cilinder

F1	72D 7018/K8/72/F1	ALPHA GR-KR 72/F1 KB
	85D 7018/K8/85/F1	ALPHA GR-KR 85/F1 KB
	92D 7018/K8/92/F1	ALPHA GR-KR 92/F1 KB
	110D 7018/K8/110/F1	ALPHA GR-KR 110/F1 KB
F2	72D 7018/K8/72/F2	ALPHA GR-KR 72/F2 KB
	85D 7018/K8/85/F2	ALPHA GR-KR 85/F2 KB
	92D 7018/K8/92/F2	ALPHA GR-KR 92/F2 KB
	110D 7018/K8/110/F2	ALPHA GR-KR 110/F2 KB
F3	72D 7018/K8/72/F3	ALPHA GR-KR 72/F3 KB
	85D 7018/K8/85/F3	ALPHA GR-KR 85/F3 KB
	92D 7018/K8/92/F3	ALPHA GR-KR 92/F3 KB
	110D 7018/K8/110/F3	ALPHA GR-KR 110/F3 KB
F4	72D 7018/K8/72/F4	ALPHA GR-KR 72/F4 KB
	85D 7018/K8/85/F4	ALPHA GR-KR 85/F4 KB
	92D 7018/K8/92/F4	ALPHA GR-KR 92/F4 KB
	110D 7018/K8/110/F4	ALPHA GR-KR 110/F4 KB
F5	72D 7018/K8/72/F5	ALPHA GR-KR 72/F5 KB
	85D 7018/K8/85/F5	ALPHA GR-KR 85/F5 KB
	92D 7018/K8/92/F5	ALPHA GR-KR 92/F5 KB
	110D 7018/K8/110/F5	ALPHA GR-KR 110/F5 KB
F9	72D 7018/K8/72/F9	ALPHA GR-KR 72/F9 KB
	85D 7018/K8/85/F9	ALPHA GR-KR 85/F9 KB
	92D 7018/K8/92/F9	ALPHA GR-KR 92/F9 KB
	110D 7018/K8/110/F9	ALPHA GR-KR 110/F9 KB
F12	72D 7018/K8/72/F12	ALPHA GR-KR 72/F12 KB
	85D 7018/K8/85/F12	ALPHA GR-KR 85/F12 KB
	92D 7018/K8/92/F12	ALPHA GR-KR 92/F12 KB
	110D 7018/K8/110/F12	ALPHA GR-KR 110/F12 KB
F14	72D 7018/K8/72/F14	ALPHA GR-KR 72/F14 KB
	85D 7018/K8/85/F14	ALPHA GR-KR 85/F14 KB
	110D 7018/K8/110/F14	ALPHA GR-KR 110/F14 KB

216

# Dieckmann Rombus

D 7021/03

## Veiligheidsbeslag afgerond voor houten deuren Met of zonder kernbeveiliging

Buitenschild 12mm  
Breedte 50mm  
Binnenzijde: clipstechniek  
Stalen onderlegschild met aluminium clippschild 6mm met  
onzichtbare vijzen  
3 staalgeharte nokken  
Antiboorplaatjes in de nokken  
SKG\*\*\*



217

your world safely locked //®

Versie v1.1.2

Info@dombrecht.eu www.dombrecht.eu  
Tel: 052/44 74 84 Fax: 052/44 90 52



**Dombrecht**  
DISTRIBUTION



**Dieckmann D 7021/03**  
Zonder kernbescherming  
Kruk-Kruk



Buitschild dikte 12mm, breedte 50mm  
Binnenzijde: clipstechniek  
Stalen onderlegschild met aluminium clipsschild  
6mm met onzichtbare vijzen  
3 staalgeharte nokken  
Antiboortplaatjes in de nokken  
Onzichtbare vijzen

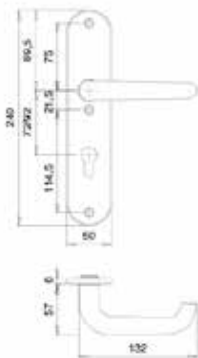

F1	72	D 7021/7203/01
	110	D 7021/1103/01
F5	110	D 7021/1103/05

218



**Dieckmann D 7021/02**  
Zonder kernbescherming  
Greep-Kruk



Buitschild dikte 12mm, breedte 50mm  
Binnenzijde: clipstechniek  
Stalen onderlegschild met aluminium clipsschild  
6mm met onzichtbare vijzen  
3 staalgeharte nokken  
Antiboortplaatjes in de nokken  
Onzichtbare vijzen

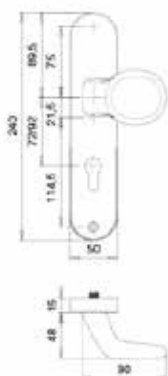

F1	110D	7021/0272/01
F5	110D	7021/0211/05
F9	110D	7021/0211/09



**Dieckmann D 7022/03**   
 Met kernbescherming  
 Kruk-Kruk

Buitschild dikte 12mm, breedte 50mm  
 Binnenzijde: clipstechniek  
 Stalen onderlegschild met aluminium clipsschild 6mm  
 Staalplaat rond de cilinder  
 Cilinderoverstand: 12-18mm  
 3 staalgeharte nokken  
 Antiboorplaatjes in de nokken  
 Onzichtbare vijzen

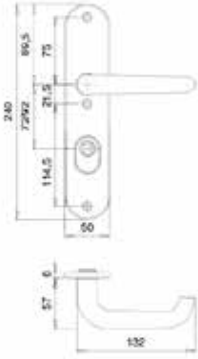

- F1 72D 7022/7203/01  
110D 7022/1103/01
- F5 72D 7022/7203/05  
110D 7022/1103/05
- F9 D 7022/1103/09



**Dieckmann D 7022/02**   
 Met kernbescherming  
 Greep-Kruk

Buitschild dikte 12mm, breedte 50mm  
 Binnenzijde: clipstechniek  
 Stalen onderlegschild met aluminium clipsschild 6mm  
 Staalplaat rond de cilinder  
 Cilinderoverstand: 12-18mm  
 3 staalgeharte nokken  
 Antiboorplaatjes in de nokken  
 Onzichtbare vijzen

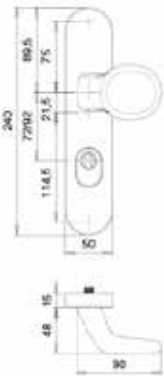

- F1 72D 7022/0272/01  
110D 7022/0211/01
- F5 72D 7022/0272/05  
110D 7022/0211/05
- F9 110D 7022/0211/09

# Dieckmann **K**ronos

## Veiligheidsbeslag afgerond voor smaldeuren

Breedte 35mm  
Dikte buitenschild 10mm  
Dikte binnenschild 10mm  
Buitenkrak vast draaibaar gelagerd  
Binnenkrak vast draaibaar gelagerd met veer  
Clips afdekbinnenschild waardoor de vijzen niet zichtbaar zijn.  
3 vijzen M6, verdekt bevestigd  
Buitenschild met staalplaat rond de cilinder  
Buitenschild met metalen steunnokken 10mm

**220**



**Dieckmann D 1300/0035**

Zonder kernbescherming  
Kruk-Kruk

Schild dikte: 10mm binnen, 10mm buiten  
Breedte: 35mm  
Buitenkruk vast draaibaar gelagerd  
Binnenkruk vast draaibaar gelagerd met veer  
Binnenschild met clipstechniek op massive onderbasis  
Staalplaat rond de cilinder  
Buitschild met metalen steunnokken 10mm ( 3 M6 vijzen)

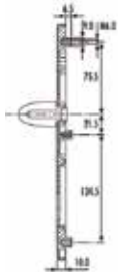

F1 70D 1300/0035/70/F1

72D 1300/0635/72/F1

92D 1300/0035/92/F1

F5 72D 1300/0635/72/F5

92D 1300/0035/92/F5

F9 72D 1300/0635/72/F9

92D 1300/0035/92/F9

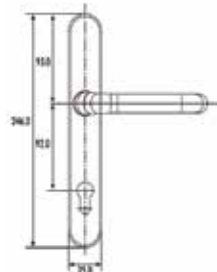

F12 72D 1300/0635/72/F12

92D 1300/0035/92/F12

F14 92D 1300/0035/92/F14

EST 72D 1300/0635/72/00

92D 1300/0035/92/00

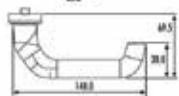

**Dieckmann D 1300/K2/2035**

Zonder kernbescherming

Greep-Kruk

Schild dikte: 10mm binnen, 10mm buiten

Breedte: 35mm

Buitenkruk vast draaibaar gelagerd

Binnenkruk vast draaibaar gelagerd met veer

Binnenschild met clipstechniek op massive onderbasis

Staalplaat rond de cilinder

Buitschild met metalen steunnokken 10mm (3 M6 vijzen)



F1 72D 1300/K2/2635/72/F1

92D 1300/K2/2035/92/F1

F2 72D 1300/K2/2635/72/F2

F5 72D 1300/K2/2635/72/F5

92D 1300/K2/2035/92/F5

F9 29D 1300/K2/2035/92/F9

F12 72D 1300/2635/72/F12

92D 1300/K2/2035/92F12

F14 92D 1300/K2/2035/92/F14

EST 72D 1300/K2/2635/72/00

92D 1300/K2/2035/92/00

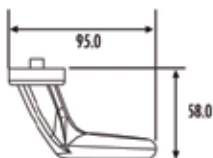
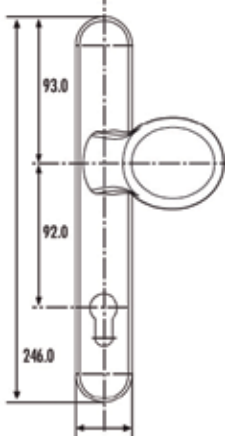

222



**Dieckmann D 1300/0045**

Met kernbescherming  
Kruk-Kruk

Schild dikte: 10mm binnen, 10mm buiten  
Breedte: 35mm  
Buitenkruk vast draaibaar gelagerd  
Binnenkruk vast draaibaar gelagerd met veer  
Binnenschild met clipstechniek op massive onderbasis  
Cilinderoverstand: 12-18mm  
Buitenschild met metalen steunnokken 10mm ( 3 M6 vijzen)

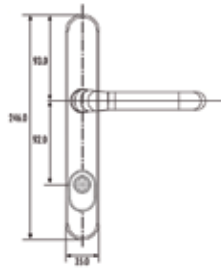
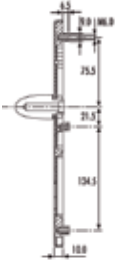

- F1 72D 1300/0645/72/F1  
92D 1300/0045/92/F1
- F5 72D 1300/0645/72/F5  
92D 1300/0045/92/F5
- F9 72D 1300/0645/72/F9  
92D 1300/0045/92/F9
- F12 72D 1300/0645/72/F12  
92D 1300/0045/92/F12
- F14 92D 1300/0045/92/F14
- EST 72D 1300/0645/72/00  
92D 1300/0045/92/00



**Dieckmann D 1300/K2/2045**

Met kernbescherming  
Greep-Kruk

Schild dikte: 10mm binnen, 10mm buiten  
Breedte: 35mm  
Buitenkruk vast draaibaar gelagerd  
Binnenkruk vast draaibaar gelagerd met veer  
Binnenschild met clipstechniek op massive onderbasis  
Staalplaat rond de cilinder  
Buitschild met metalen steunnokken 10mm ( 3 M6 vijzen)

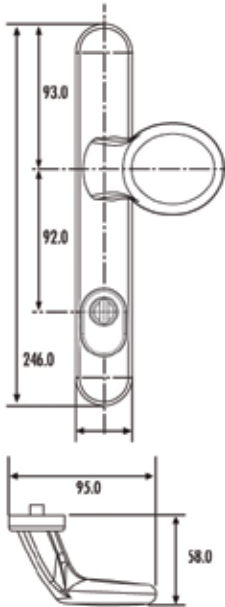

F1	72D 1300/K2/2645/72/F1
	92D 1300/K2/2045/92/F1
F3	72D 1300/K2/2645/72/F3
F5	72D 1300/K2/2645/72/F5
	92D 1300/K2/2045/92/F5
F9	D 1300/K2/2045/92/F9
F12	72D 1300/K2/645/72/F12
	92D 1300/2045/92/F12
F14	92D 1300/2045/92/F14
EST	72D 1300/K2/2645/72/00
	92D 1300/K2/2045/92/00

**224**

# Dieckmann Pan

D 320 D 312

**Veiligheidsbeslag hoekig voor smaldeuren  
Zonder kernbeveiliging**

Schild 10mm  
Volle alu platen  
30mm breed  
245 mm lang

D 320 Kruk-Kruk  
D 312 Greep-Kruk



225

your world safely locked //®

Versie v1.1.2

Info@dombrecht.eu www.dombrecht.eu  
Tel: 052/44 74 84 Fax: 052/44 90 52



**Dombrecht**  
DISTRIBUTION

## Dieckmann D 320 & D 312

Zonder kernbescherming



Schild 10mm  
Volle aluminium platen  
30mm breed

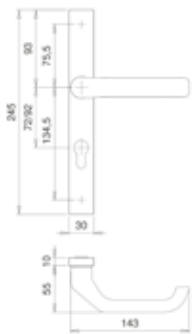

### D 320 Kruk-Kruk

F1	72D 320 Z/F1	PAN KR-KR 72/F1 L
	85D 320/85/F1	PAN KR-KR 85/F1 L
	92D 320 H/F1	PAN KR-KR 92/F1 L
	110D 320/110/F1	PAN KR-KR 110/F1 L
F2	72D 320 Z/F2	PAN KR-KR 72/F2 L
	92D 320 H/F2	PAN KR-KR 92/F2 L
F3	85D 320/85/F3	PAN KR-KR 85/F3 L
F4	70D 320/70/8/F4	PAN KR-KR 70/F4 L
F5	72D 320 Z/F5	PAN KR-KR 72/F5 L
	85D 320/85/F5	PAN KR-KR 85/F5 L
	92D 320 H/F5	PAN KR-KR 92/F5 L
	110D 320/110/F5	PAN KR-KR 110/F5 L
F12	72D 320 Z/F12	PAN KR-KR 72/F12 L
	85D 320/85/F12	PAN KR-KR 85/F12 L
	92D 320 H/F12	PAN KR-KR 92/F12 L
	110D 320/110/F12	PAN KR-KR 110/F12 L

### D 312 Greep - Kruk

F1	72D 312 Z/F1	PAN GR-KR 72/F1
	85D 312/85/F1	PAN GR-KR 85/F1
	92D 312 H/F1	PAN GR-KR 92/F1
	110D 312/110/F1	PAN GR-KR 110/F1
F2	72D 312 Z/F2	PAN GR-KR 72/F2
	85D 312/85/F2	PAN GR-KR 85/F2
	92D 312 H/F2	PAN GR-KR 92/F2
F5	85D 312/85/F5	PAN GR-KR 85/F5
	110D 312/110/F5	PAN GR-KR 110/F5
F12	72D 312 Z/F12	PAN GR-KR 72/F12
	85D 312/85/F12	PAN GR-KR 85/F12
	92D 312 H/F12	PAN GR-KR 92/F12
F14	110D 312/110/F12	PAN GR-KR 110/F12
	72D 312 Z/F14	PAN GR-KR 72/F14

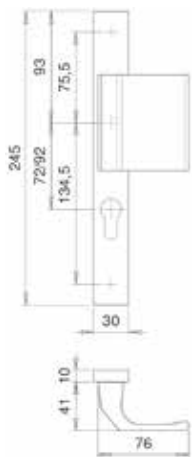

# Dieckmann Rozetten

D 8905 D890020

## Smalrozet met 2 bevestigingsvijzen onder slot

Buitenschild van 12mm dik  
2 stalen nokken  
Staanplaat rond de cilinder  
30mm breedte  
Vijzen M6

D 8905 zonder kernbeveiliging  
D 890020 met kernbeveiliging



227



## Dieckmann D 8905 & D 890020

Schild dikte: 12mm  
 Schild dikte: 15mm op D890020  
 Breedte: 30mm  
 2 stalen nokken  
 Vijzen M6  
 Staalplaat rond de cilinder  
 Cilinderoverstand: 12-18mm op D890020  
 Met vijzen onder het slot



### Zonder kernbeveiliging

F1	D 8905/F1	SMALROZET F1 2 VIJZEN ONDER
F2	D 8905/F2	SMALROZET F2 2 VIJZEN ONDER
F4	D 8905/F4	SMALROZET F4 2 VIJZEN ONDER
F5	D 8905/F5	SMALROZET F5 2 VIJZEN ONDER
F9	D 8905/F9	SMALROZET F9 2 VIJZEN ONDER
F12	D 8905/F12	SMALROZET F12, 2 VIJZEN ONDER

### Met kernbeveiliging

F1	D 890020/F1	SMALROZET F1 KB,2 VIJZEN ONDER
F2	D 890020/F2	SMALROZET F2 KB,2 VIJZEN ONDER
F4	D 890020/F4	SMALROZET F4 KB,2 VIJZEN ONDER
F5	D 890020/F5	SMALROZET F5 KB,2 VIJZEN ONDER
F9	D 890020/F9	SMALROZET F9 KB,2 VIJZEN ONDER
F12	D 890020/F12	SMALROZET F12 KB,2 VIJZEN ONDER

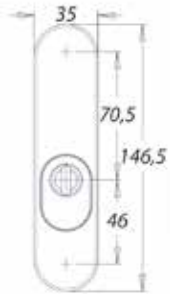



**Dieckmann D 6533**  
Zonder kernbescherming

Diameter: 55mm  
Ditke: 12mm  
Gegoten nokken  
Onzichtbare M5 vijzen aan binnenzijde  
Binnenschild: Clipstechniek  
EST & PVD uitvoering SKG\*\*\*

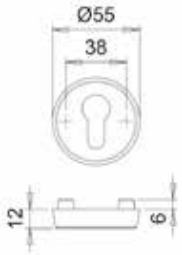

F1	D 6533/F1
F2	D 6533/F2
F3	D 6533/F3
F4	D 6533/F4
F5	D 6533/F5
F9	D 6533/F9
F12	D 6533/F12
F14	D 6533/F14
EST	D 6533/EST



**Dieckmann D 7554**



Zonder kernbescherming

Diameter: 52mm  
 Dikte: 12mm  
 2 stalen nokken  
 Antiboorplaatjes in de nokken  
 Onzichtbare M6 vijzen aan binnenzijde  
 Binnenschild: Clipstechniek

- F1 D 7554/F1
- F2 D 7554/F2
- F3 D 7554/F3
- F4 D 7554/F4
- F5 D 7554/F5
- F9 D 7554/F9
- F12 D 7554/F12
- F14 D 7554/F14

230



**Dieckmann D 7156**

Met kernbescherming

Diameter: 55mm  
 Dikte: 15mm  
 2 gegoten noken  
 Cilinderoverstand: 10-16mm  
 Voor EST uitvoering: 8-15mm  
 Automatisch regelbare kernbeveiliging  
 Onzichtbare M5 vijzen aan binnenzijde door clipdeksel  
 EST uitvoering: SKG\*\*\*

- F1 D 7156/0000/F1
- F2 D 7156/0000/F2
- F3 D 7156/0000/F3
- F4 D 7156/0000/F4
- F5 D 7156/0000/F5
- F9 D 7156/0000/F9
- F12 D 7156/0000/F12
- F14 D 7156/0000/F14
- EST D 7156/0000/EST

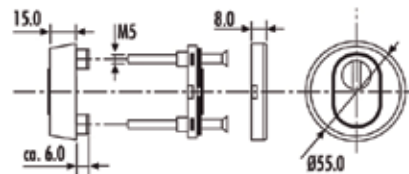



## SAB 304

Met kernbescherming

Diameter: 60mm

Dikte: 14,5mm

Cilinderoverstand: 14,5-17,5mm

Regelbare kernbeveiliging door middel van ringen

aan de binnenkant onzichtbare M5 vijzen door clipdeksel



Brons	SAB 302 OB
Messing	SAB 302 OLVS
Inox	SAB 302 OXSS



Brons	SAB 304 OB
Crome	SAB 304 OCLS
Messing	SAB 304 OLVS
Inox	SAB 304 OXSS

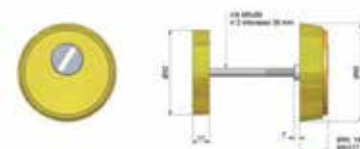
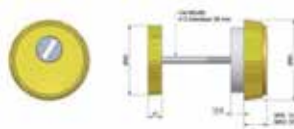



## Dieckmann D 817 & D 811

Zonder kernbescherming

D 811 Schuifrozet

Massieve zamac onderconstructie

Demontagebeveiliging door bajonetsluiting en cilinder-inzetstop

Verdekte vijzen

Geen zichtbare gleuf

D 817 Kleefrozet

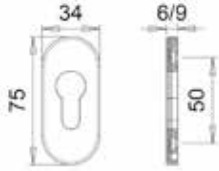

### Schuifrozet 6mm

F1 D 811/6MM/F1 SCHUIFROZET 6MM/F1

F2 D 811/6MM/F2 SCHUIFROZET 6MM/F2

F5 D 811/6MM/F5 SCHUIFROZET 6MM/F5

F12 D 811/6MM/F12 SCHUIFROZET 6MM/F12

F14 D 811/6MM/F14 SCHUIFROZET 6MM/F14

EST D 811/6MM/EST SCHUIFROZET 6MM/INOX

M1 D 811/6MM/M1 SCHUIFROZET 6MM/M1 PVD

### Schuifrozet 9mm

F1 D 811/9MM/F1 SCHUIFROZET 9MM/F1

F3 D 811/9MM/F3 SCHUIFROZET 9MM/F3

F5 D 811/9MM/F5 SCHUIFROZET 9MM/F5

F12 D 811/9MM/F12 SCHUIFROZET 9MM/F12

F14 D 811/9MM/F14 SCHUIFROZET 9MM/F14

EST D 811/9MM/EST SCHUIFROZET 9MM/INOX

M1 D 811/9MM/M1 SCHUIFROZET 9MM/M1 PVD

### Kleefrozet 2,5mm

F1 D 817/F1 KLEEFROZET 65.5X28X2.5MM F1

F5 D 817/F5 KLEEFROZET 65.5X28X2.5MM F5

F12 D 817/F12 KLEEFROZET 65.5X28X2.5MM F12

EST D 817/EST KLEEFROZET 65.5X28X2.5MM INOX

232



**Dieckmann D 290**  
Binnenschild vaste kruk op plaat

Met patentgaten

F1	72D 290/72/125FD/F1
	85D 290/85/125FD/F1
	92D 290/92/125FD/F1
	110D 290/110/125FD/F1
F2	72D 290/72/125FD/F2
	85D 290/85/125FD/F2
	92D 290/92/125FD/F2
	110D 290/110/125FD/F2
F3	72D 290/72/125FD/F3
	110D 290/110/125FD/F3
F4	72D 290/72/125FD/F4
	85D 290/85/125FD/F4
	92D 290/92/125FD/F4
	110D 290/110/125FD/F4
F5	72D 290/72/125FD/F5
	85D 290/85/125FD/F5
	92D 290/92/125FD/F5
	110D 290/110/125FD/F5
F9	72D 290/72/125FD/F9
	85D 290/85/125FD/F9
	92D 290/92/125FD/F9
	110D 290/110/125FD/F9
F12	72D 290/72/125FD/F12
	92D 290/92/125FD/F12
	110D 290/110/125FD/F12
F14	110D 290/110/125FD/F14



**Dieckmann D 323**  
 Binnenschild voor D8905-89020

Breedte : 30mm  
 Lengte: 280mm  
 Vijzen onder het slot

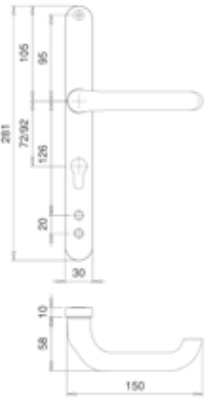

F1	72D 323/72/F1	BINNENSCHILD VERLENGD 72/F1
	85D 323/85/F1	BINNENSCHILD VERLENGD 85/F1
	92D 323/92/F1	BINNENSCHILD VERLENGD 92/F1
F4	110D 323/110/F1	BINNENSCHILD VERLENGD 110/F1
	72D 323/72/F4	BINNENSCHILD VERLENGD 72/F4
	85D 323/85/F4	BINNENSCHILD VERLENGD 85/F4
F5	110D 323/110/F4	BINNENSCHILD VERLENGD 110/F4
	72D 323/72/F5	BINNENSCHILD VERLENGD 72/F5
	85D 323/85/F5	BINNENSCHILD VERLENGD 85/F5
F9	92D 323/92/F5	BINNENSCHILD VERLENGD 92/F5
	110D 323/110/F5	BINNENSCHILD VERLENGD 110/F5
	72D 323/72/F9	BINNENSCHILD VERLENGD 72/F9
F12	85D 323/85/F9	BINNENSCHILD VERLENGD 85/F9
	92D 323/92/F9	BINNENSCHILD VERLENGD 92/F9
	110D 323/110/F9	BINNENSCHILD VERLENGD 110/F9
F12	72D 323/72/F12	BINNENSCHILD VERLENGD 72/F12
	85D 323/85/F12	BINNENSCHILD VERLENGD 85/F12
	92D 323/92/F12	BINNENSCHILD VERLENGD 92/F12
	110D 323/110/F12	BINNENSCHILD VERLENGD 110/F12

234



**Dieckmann D 1003 & D 1002**

**Vensterkrukken**

Drukcilinder met 1 sleutel  
 Diameter nokken: 10mm  
 Stift: 7mm, 32mm vrije lengte  
 Afstand tussen de vijsgaten: 43mm  
 D 1002 weerstaat aan een druk van 100Nm beveiliging tegen het afbreken van buitenaf  
 D 1002 SKG\*\*   
 Metalen onderconstructie

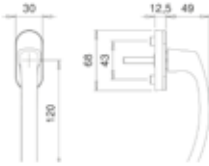

F1	D 1003/2035/F1	VENSTERKROUK AFSLUITBAAR F1
F5	D 1003/2035/F5	VENSTERKROUK AFSLUITBAAR F5
F12	D 1003/2035/F12	VENSTERKROUK AFSLUITBAAR F12

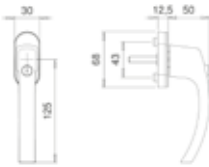

F1	D 1002/1035/F1	VENSTERKROUK 100 SKG ZONDER SL. F1
	D 1002/4035/F1	VENSTERKROUK 100 SKG AFSLUITBAAR F1
F12	D 1002/1035/F12	VENSTERKROUK 100 SKG ZONDER SL. F12
	D 1002/4035/F12	VENSTERKROUK 100N AFSLUITBAAR F12



**Dieckmann D Rolladendrpr**

**Rolluikkrukkenpaar**

Uitsteek 14mm aan de rolluikkrukzijde

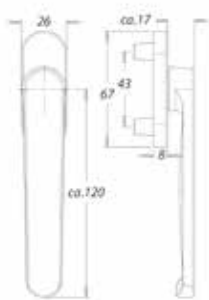

F1	D ROLLADENDRPR F1
F2	D ROLLADENDRPR F2
F3	D ROLLADENDRPR F3
F4	D ROLLADENDRPR F4
F5	D ROLLADENDRPR F5
F9	D ROLLADENDRPR F9
F12	D ROLLADENDRPR F12
F14	D ROLLADENDRPR F14



## Dieckmann D 125

D 125  
Krukpaar



### 47mm Tige

F1	D 125 Z/F1	KRUKPAAR 8*47 MM F1
F2	D 125 Z/F2	KRUKPAAR 8*47 MM F2
F3	D 125 Z/F3	KRUKPAAR 8*47 MM F3
F4	D 125 Z/F4	KRUKPAAR 8*47 MM F4
F5	D 125 Z/F5	KRUKPAAR 8*47 MM F5
F9	D 125 Z/F9	KRUKPAAR 8*47 MM F9
F12	D 125 Z/F12	KRUKPAAR 8*47 MM F12
F14	D 125 Z/F14	KRUKPAAR 8*47 MM F14

### 67mm Tige

F1	D 125 Z/F1/67 MM	KRUKPAAR 8*67 MM F1
F2	D 125 Z/F2/67 MM	KRUKPAAR 8*67 MM F2
F3	D 125 Z/F3/67 MM	KRUKPAAR 8*67 MM F3
F4	D 125 Z/F4/67 MM	KRUKPAAR 8*67 MM F4
F5	D 125 Z/F5/67 MM	KRUKPAAR 8*47 MM F5/67 MM
F9	D 125 Z/F9/67MM	KRUKPAAR 8*67 MM F9
F12	D 125 Z/F12/67 MM	KRUKPAAR 8*67 MM F12

236



## Dieckmann D 237

D 237  
 Langschilden  
 Breedte: 41mm  
 Lengte: 213mm  
 Profielcilinder of baardsleutel

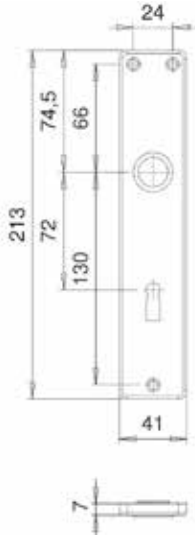

### PZ cilinder

F1	D 237 PZ/55/F1	LANGSCHILD PZ 55MM F1
	D 237 Z/PZ/F1	LANGSCHILD PZ 72 MM F1
	D 237/85/PZ/F1	LANGSCHILD PZ 85 MM F1
	D 237/92/PZ/F1	LANGSCHILD PZ 92 MM F1
	D 237/110/PZ/F1	LANGSCHILD PZ 110 MM F1
F2	D 237 Z/PZ/F2	LANGSCHILD PZ 72 MM F2
	D 237/92/PZ/F2	LANGSCHILD PZ 92 MM F2
	D 237/110/PZ/F2	LANGSCHILD PZ 110 MM F2
F3	D 237 Z/PZ/F3	LANGSCHILD PZ 72 MM F3
	D 237/85/PZ/F3	LANGSCHILD PZ 85 MM F3
	D 237/110/PZ/F3	LANGSCHILD PZ 110 MM F3
F4	D 237 Z/PZ/F4	LANGSCHILD PZ 72 MM F4
	D 237/85/PZ/F4	LANGSCHILD PZ 85 MM F4
	D 237/110/PZ/F4	LANGSCHILD PZ 110 MM F4
F5	D 237 Z/PZ/F5	LANGSCHILD PZ 72 MM F5
	D 237/85/PZ/F5	LANGSCHILD PZ 85 MM F5

237



## Dieckmann D 237

D 237  
Langschilden  
Breedte: 41mm  
Lengte: 213mm  
Profielcilinder of baardsleutel

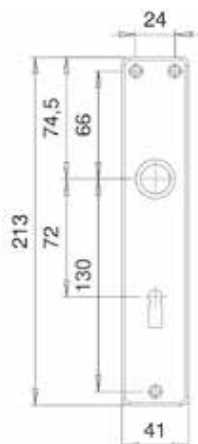

### Voor Baardsleutel

F1	D 237 Z/BB/F1	LANGSCHILD BB 72 MM F1
	D 237/92/BB/F1	LANGSCHILD BB 92 MM F1
	D 237/110/BB/F1	LANGSCHILD BB 110 MM F1
F2	D 237 Z/BB/F2	LANGSCHILD BB 72 MM F2
	D 237/92/BB/F2	LANGSCHILD BB 92 MM F2
	D 237/110/BB/F2	LANGSCHILD BB 110 MM F2
F3	D 237 Z/BB/F3	LANGSCHILD BB 72 MM F3
	D 237/110/BB/F3	LANGSCHILD BB 110 MM F3
F4	D 237 Z/BB/F4	LANGSCHILD BB 72 MM F4
	D 237/110/BB/F4	LANGSCHILD BB 110 MM F4
F5	D 237 Z/BB/F5	LANGSCHILD BB 72 MM F5
	D 237/110/BB/F5	LANGSCHILD BB 110 MM F5

### Voor WC sloten

D 237/78/WC/F1	LANGSCHILD WC 78 MM F1
D 237/78/WC/F2	LANGSCHILD WC 78 MM F2

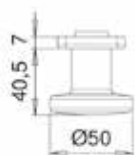

238



**Dieckmann Andere rozetten**



D 087/WC3-4/F1 WC ROZETTENPAAR F1

D 087/WC3-4/F2 WC ROZETTENPAAR F2

D 087/WC3-4/F3 WC ROZETTENPAAR F3

D 087/WC3-4/F4 WC ROZETTENPAAR F4



D 085/BB/F1 SLEUTELROZET BB F1

D 085/BB/F2 SLEUTELROZET BB F2

D 085/BB/F4 SLEUTELROZET BB F4



D 086/PZ/F1 SLEUTELROZET PZ F1

D 086/PZ/F12 SLEUTELROZET PZ F12

D 086/PZ/F14 SLEUTELROZET PZ F14

D 086/PZ/F2 SLEUTELROZET PZ F2

D 086/PZ/F3 SLEUTELROZET PZ F3

D 086/PZ/F4 SLEUTELROZET PZ F4

D 086/PZ/F5 SLEUTELROZET PZ F5

D 086/PZ/F9 SLEUTELROZET PZ F9

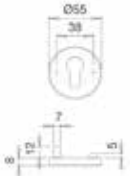

D 088/BL/F1 ROZET BLIND F1

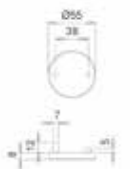



**Dieckmann Andere rozetten**

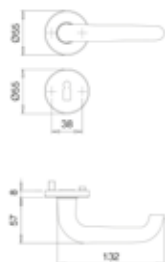

D 104 Z/37MM/F1	KRUKPAAR U 8*37 MM F1
D 104 Z/37MM/F2	KRUKPAAR U 8*37 MM F2
D 104 Z/F1	KRUKPAAR U 8*47 MM F1
D 104 Z/F2	KRUKPAAR U 8*47 MM F2
D 104 Z/F4	KRUKPAAR U 8*47 MM F4
D 104 Z/LOCHTEIL/F1	KRUKGATDEEL 104 F1
D 104 Z/LOCHTEIL/F4	KRUKGATDEEL 104 F4
D 104 Z/LOCHTEIL/F5	KRUKGATDEEL 104 F5
D 104Z/100MM/F1	KRUKPAAR U 8*100 MM F1
D 104Z/67MM/F1	KRUKPAAR U 8*67 MM F1
D 104Z/67MM/F3	KRUKPAAR U 8*67 MM F3
D 104Z/67MM/F4	KRUKPAAR U 8*67 MM F4
D 104Z/67MM/F5	KRUKPAAR U 8*67 MM F5

240



D 082/0000/EST	KRUKROZET INOX
D 082/F1	KRUKROZET F1
D 082/F12	KRUKROZET F12
D 082/F14	KRUKROZET F14
D 082/F2	KRUKROZET F2
D 082/F3	KRUKROZET F3
D 082/F4	KRUKROZET F4
D 082/F5	KRUKROZET F5
D 082/F9	KRUKROZET F9

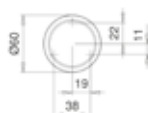

D 1080/7020 F1	KNOP OP ROZET F1
----------------	------------------

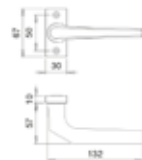

D 1314/F1	KRUK OP MASSIEFROZET F1
-----------	-------------------------



**Dieckmann Andere rozetten**

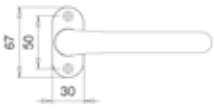

D 308/F1 KRUK OP OVAALROZET/F1

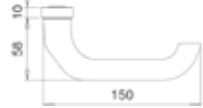

D 812/6MM/F1 SCHUIFROZET 6MM/F1

D 812/6MM/F2 SCHUIFROZET 6MM/F2

D 812/6MM/F5 SCHUIFROZET 6MM/F5

D 812/9MM/F2 SCHUIFROZET 9MM/F2

D 812/9MM/F5 SCHUIFROZET 9MM/F5

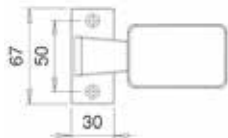
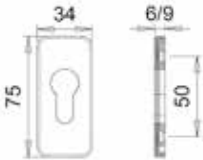

D 315/F1 TREKKER OP ROZET F1

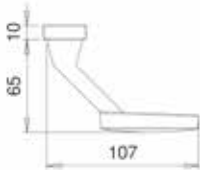

D 108 Z/EST KRUKPAAR EST 35-35MM

D 108 Z/F1 KRUKPAAR F1

D 108 Z/F2 KRUKPAAR F2



D 109 Z/F14 KRUKPAAR U 8\*47 MM F14

D 109 Z/F9 KRUKPAAR U 8\*47 MM F9

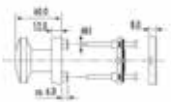

D 1062/5020 F1 KOGELKNOP K5 VAST OP ROZET F1

D 1062/7020 F1 KNOP K7 VAST OP ROZET F1



**Dieckmann Andere rozetten**



D 137 Z/F1	KRUKPAAR 8*47 MM F1
D 137 Z/F1/37 MM	KRUKPAAR 8*34 MM F1 7CM TIGE
D 137 Z/F1/57 MM	KRUKPAAR 8*57 MM F1 9CM TIGE
D 137 Z/F2/37 MM	KRUKPAAR 8*34 MM F2 7CM TIGE
D 137 Z/F2/57 MM	KRUKPAAR 8*57 MM F2 9CM TIGE
D 137 Z/F3	KRUKPAAR 8*47 MM F3

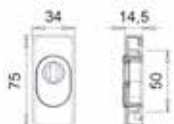

D 816/EST	HOEKIG ROZET INOX
-----------	-------------------

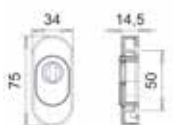

D 815 ZA/EST	INOX SMALROZET KB OVAAL
--------------	-------------------------

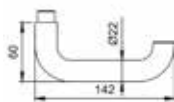

D 103/H/F1	KRUKPAAR 103 F1
D 103/H/F4	KRUKPAAR 103 F4



D 390 F1	KRUK OP ROZET F1
D 390/F1	KRUK OP MASSIEFROZET F1 L
D 390/F2	KRUK OP MASSIEFROZET F2 L
D 390/F5	KRUK OP MASSIEFROZET F5

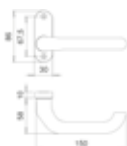

D 391/F1	KRUK OP MASSIEFROZET F1 U
D 391/F5	KRUK OP MASSIEFROZET F5 U

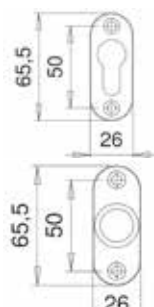

D 392/F1	GESTANSTE OVALE KRUKROZET F1
D 393/F1	GESTANSTE OVALE ROZET F1 PZ



## Dieckmann Onderdelen



D 8370000000	WISSELSTIFT 8X95 MM TYP O
--------------	---------------------------

D 8371000000	WISSELSTIFT 8X100 MM TYP O
--------------	----------------------------

D 8374000000	WISSELSTIFT 8X130MM TYP O
--------------	---------------------------

D 8376000000	WISSELSTIFT 8X140MM TYP O
--------------	---------------------------

D 8377000000	WISSELSTIFT 8X115MM TYP O
--------------	---------------------------



D 0576080650	WISSELSTIFT EENZIJDIG SK 8*65
--------------	-------------------------------

D 0576080800	WISSELSTIFT EENZIJDIG SK 8*80
--------------	-------------------------------

D 0576100650	WISSELSTIFT EENZIJDIG SK 10*65
--------------	--------------------------------

D 0576100800	WISSELSTIFT EENZIJDIG SK 10*80
--------------	--------------------------------

D 0576101000	WISSELSTIFT EENZIJDIG SK 10*10
--------------	--------------------------------

D 0592100800	WISSELSTIFT TYPE T 10*80
--------------	--------------------------



D 0594080650	WISSELSTIFT TYPE B 8*65
--------------	-------------------------

D 0594080800	WISSELSTIFT TYPE B 8*80
--------------	-------------------------

D 0594100650	WISSELSTIFT TYPE B 10*65
--------------	--------------------------



D 0595100800	WISSELSTIFT TYPE U 8*10*80
--------------	----------------------------



D 0572071150	MASSIEFSTIFT M7*110
--------------	---------------------

D 0572080450	MASSIEFSTIFT M8*45
--------------	--------------------

D 0572080550	MASSIEFSTIFT M8*55
--------------	--------------------

D 0572080600	MASSIEFSTIFT M8*60
--------------	--------------------

D 0572080750	MASSIEFSTIFT M8*75
--------------	--------------------

D 0572080900	MASSIEFSTIFT M8*90
--------------	--------------------

D 0572081000	MASSIEFSTIFT M8*100
--------------	---------------------

D 0572081200	MASSIEFSTIFT M8*120
--------------	---------------------

D 0572081300	MASSIEFSTIFT M8*130
--------------	---------------------

D 0572081400	MASSIEFSTIFT M8*140
--------------	---------------------

D 0572081500	MASSIEFSTIFT M8*150
--------------	---------------------

D 0572081600	MASSIEFSTIFT M8*160
--------------	---------------------

D 0572091200	MASSIEFSTIFT M9*120
--------------	---------------------

D 0572101200	MASSIEFSTIFT M10*120
--------------	----------------------



D 0587080900	ROLWISSELSTIFT 8*90 TYPE O/M
D 0587081000	ROLWISSELSTIFT 8*100 TYPE O/M
D 0587081150	ROLWISSELSTIFT 8*115 TYPE O/M
D 0587081300	ROLWISSELSTIFT 8*130 TYPE O/M
D 0587081400	ROLWISSELSTIFT 8*140 TYPE O/M



D 0588080800	KRUKSTIFT DUBBEL 8*80 TYPE P
D 0588081000	KRUKSTIFT DUBBEL 8*100 TYPE P
D 0588081200	KRUKSTIFT DUBBEL 8*120 TYPE P
D 0588081400	KRUKSTIFT DUBBEL 8*140 TYPE P



D 0589081300	KRUKSTIFT TYPE SK 8*130
D 0589101300	KRUKSTIFT TYPE SK 10*130



D 104Z/STIFT/47MM/F1	KRUKSTIFTDEEL 104 47 MM F1
D 104Z/STIFT/67MM/F1	KRUKSTIFTDEEL 104 67 MM F1
D 104Z/STIFT/67MM/F2	KRUKSTIFTDEEL 104 67 MM F2
D 104Z/STIFT/67MM/F4	KRUKSTIFTDEEL 104 67 MM F4
D 104Z/STIFT/67MM/F5	KRUKSTIFTDEEL 104 67 MM F5



D 0584004502	VIJZEN M4*45
D 0584007502	VIJZEN M4*75
D 0546006500	VIJZEN M5*65
D 0546008000	VIJZEN M5*80
D 0546009000	VIJZEN M5*90
D 0551000502	VIJZEN M6*40
D 0551000532	VIJZEN M6*53
D 0551000533	VIJZEN M6*53 MESSING
D 0551000602	VIJZEN M6*60
D 0551000652	VIJZEN M6*65
D 0551000653	VIJZEN M6*65 MESSING
D 0551000654	VIJZEN M6*65 BRUNIERT
D 0551000702	VIJZEN M6*70
D 0551000703	VIJZEN M6*70 BRONS
D 0551000704	VIJZEN M6*70 BRUNIERT
D 05510008012	VIJZEN M6*80 WIT
D 0551000802	VIJZEN M6*80



## Dieckmann Onderdelen



D 0551000803	VIJZEN M6*80 MESSING
D 0551000804	VIJZEN M6*80 BRUNIERT
D 0551000805	VIJZEN M6*80 BRUIN
D 0551000902	VIJZEN M6*90
D 0551000903	VIJZEN M6*90 MESSING
D 0551000904	VIJZEN M6*90 BRUNIERT



D 0555000600	DRAADSTANG M5*60
D 0555000750	DRAADSTANG M5*75
D 0555000800	DRAADSTANG M5*80
D 0555000900	DRAADSTANG M5*90
D 0550000450	DRAADSTANG M6*45
D 0550000500	DRAADSTANG M6*50
D 0550000600	DRAADSTANG M6*60
D 0550000700	DRAADSTANG M6*70
D 0550000750	DRAADSTANG M6*75
D 0550000800	DRAADSTANG M6*80
D 0550000900	DRAADSTANG M6*90



D 0552000002	HULSMOEREN M6 F1
D 0552000003	HULSMOEREN M6 F3
D 0552000004	HULSMOEREN M6 F4
D 0552000005	HULSMOEREN M6 F5
D 0552000012	HULSMOEREN M6 F12
D 0552000014	HULSMOEREN M6 F14

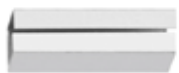

D 0554070800	REDUCTIESTUK 7-8MM
D 0554080850	REDUCTIESTUK 8-8,5MM
D 0554080900	REDUCTIESTUK 8-9MM
D 0554081000	REDUCTIESTUK 8-10MM
D 0554091000	REDUCTIESTUK 9-10MM



D 05590000	KRUKSTIFT TYPE R
------------	------------------



D 0562606000 PANIEKSTIFT 9 MM 60/60

---



D 0564000002 VIJS+HULSMOER M4\*22 F1

---



D 0565000002 VIJS+HULSMOER M4\*15 F1

---

D 0565000003 VIJS+HULSMOER M4\*15 F3

---

D 0577000002 HOUDERSTIFT TYPE H F1

---

D 0577000003 HOUDERSTIFT TYPE H F3

---



D 0579000000 PLASTIC RING VOOR KRUK

---

D 0584000000 KRUKGELEIDER

---



D 0597000000 INBUSSCHROEF TYPE S

---



D 0140/0810/01 ROLLUIKKR STIFTDEEL R9 8MM F1

---

# Iseo **D**eurdrangers

your world safely locked //®

Versie v1.1.2



**Dombrecht**  
DISTRIBUTION

# Iseo Deurdrangers

Basis begrippen

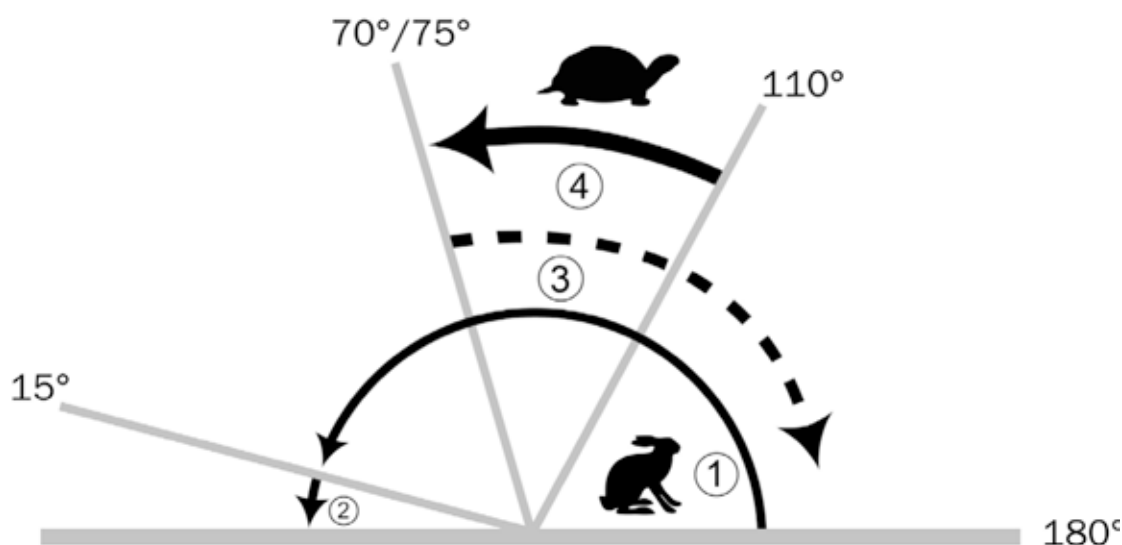

## 1: Closing Speed adjustment

Deze aanpassing werkt van het maximale openingsbereik tot de laatste 15 graden. Het past de sluitsnelheid van de deur aan binnen het hierboven beschreven bereik.

## 2: Latching action

Deze aanpassing wordt uitgevoerd tijdens de laatste 15 graden van sluitactie. Met de laatste vergrendeling kan de deur snel, stevig of soepel worden gesloten.

## 3: Adjustable Backcheck

Deze aanpassing begint vanaf 70 °. Hiermee kan de deur hydraulisch worden vertraagd wanneer deze wordt geopend. Het is mogelijk om het reductiepercentage naar wens in te stellen.

Deze aanpassing wordt voornamelijk gebruikt op deuren die naar buiten openen (bijv. Nooduitgangen, enz.).

## 4: Adjustustable Delay closing action

Deze aanpassing werkt binnen een bereik van een minimale openingshoek van 90 ° tot 75 °.

Hiermee kan het sluiten van de deur worden vertraagd. Het is mogelijk om een vertraging van 90 seconden in te stellen van bijvoorbeeld 90 ° tot 75 °.

## 5: Closing force adjustment

Deze aanpassing wordt niet weergegeven in de tekening op de vorige pagina. Hiermee kunt u echter de sluitkracht aanpassen aan de vereisten van de deur. Deze aanpassing kan op twee verschillende manieren worden bereikt:

- stelschroef
- het verplaatsen van het lichaam of de armpositie

## Basis deurdrangers

# 250

- 250. Iseo IS20  
Met schaaram
- 250. Iseo IS20  
Met vastzetarm

## Standaard deurdrangers

# 251

- 251. Iseo IS60  
Met schaaram
- 251. Iseo IS60  
Met vastzetarm
- 251. Iseo IS65  
Met glijarm
- 251. Onderdelen en benodigheden

## Stevige deurdrangers

# 252

- 252. Iseo IS110  
Met schaaram
- 252. Iseo IS110  
Met vastzetarm
- 252. Iseo IS115  
Met glijarm
- 252. Iseo IS115 RV  
Arm tegen scharnierkant
- 252. Onderdelen en benodigheden

## Zware deurdrangers

# 253

- 253. Iseo IS310  
Met schaaram
- 253. Iseo IS310  
Met vastzetarm
- 253. Iseo IS315  
Met glijarm
- 254. Iseo IS315 RV  
Arm tegen scharnierkant
- 253. Onderdelen en benodigheden  
Montageplaten

249



# Iseo Is20

Basis deurdranger

## Iseo IS20

Max. deurbreedte: 950mm

Max. deurgewicht: 80kg

Kleur: Zilver

Kracht: 2/3

Openingsdemping: Nee

Sluitvertraging: Nee

Type arm: Schaararm

Openingshoek: 180°

I 371100003 IS 20 MET SCHAARARM ZILVER

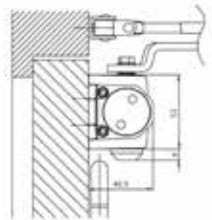
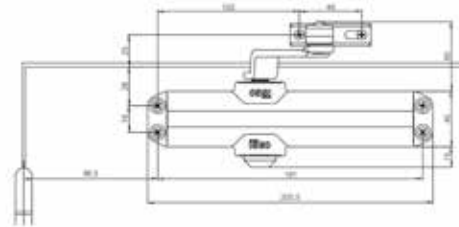

250

# Iseo IS60-65

Standaard deurdranger

## Iseo IS60

Max. deurbreedte: 1100mm

Max. deurgewicht: 100kg

Kleur: Zilver

Kracht: 2/3/4

Openingsdemping: Nee

Sluitvertraging: Nee

Type arm: schaaram

Openingshoek: 180°

I 372100003 IS 60 MET SCHAARARM ZILVER

I 370020003 ARMBEUGEL

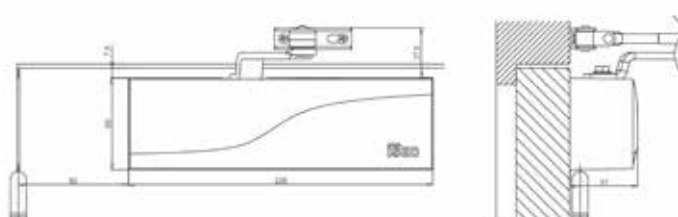

## Iseo IS65

Max. deurbreedte: 950mm

Max. deurgewicht: 80kg

Kleur: Zilver

Kracht: 3

Openingsdemping: nee

Sluitvertraging: nee

Type arm: Glijarm

Openingshoek: 180°

I 373150003 IS 65 MET GLIJARM ZILVER

I 374010003 Montage plaat IS65

I 370031000 VASTZET MECHANIEK GLIJARM

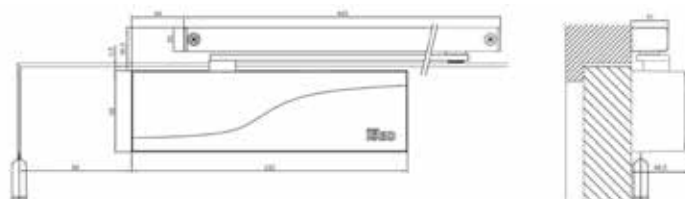

251

# Iseo Is110-115

Stevige deurdranger

## Iseo IS110

Max. deurbreedte: 1100mm  
Max. deurgewicht: 100kg  
Kleur: Zilver  
Kracht: 2-4  
Openingsdemping: Ja  
Sluitvertraging: Nee  
Type arm: Schaararm  
Openingshoek: 180°

I 374100013 IS 110 MET SCHAARARM ZILVER

I 374010003 Montage plaat IS110

I 370020003 ARMBEUGEL

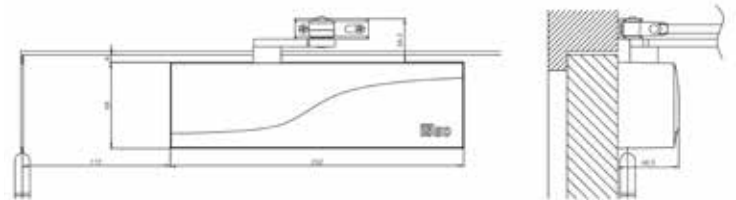

252

## Iseo IS115

Max. deurbreedte: 1250mm  
Max. deurgewicht: 120kg  
Kleur: Zilver  
Kracht: 2-4  
Openingsdemping: Ja  
Sluitvertraging: Nee  
Type arm: Glijarm  
Openingshoek: 180°

I 375150013 IS 115 MET GLIJARM ZILVER

I 376010003 Montage plaat IS115

I 370031000 VASTZET MECHANIEK GLIJARM

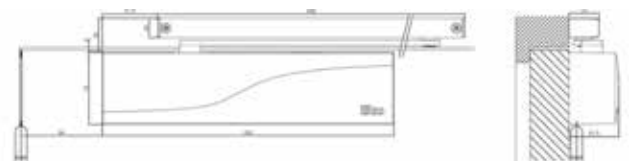

your world safely locked //®

# Iseo Is310-315

Zware deurdranger

## Iseo IS310

Max. deurbreedte: 1400mm

Max. deurgewicht: 160kg

Kleur: Zilver

Kracht: 3-6

Openingsdemping: Ja

Sluitvertraging: Ja

Type arm: Schaararm

Openingshoek: 180°

I 376100033 IS 310 MET SCHAARARM ZILVER

I 376010003 Montage plaat IS310

I 370020003 ARMBEUGEL

## Iseo IS315

Max. deurbreedte: 1250mm

Max. deurgewicht: 120kg

Kleur: Zilver

Kracht: 3-5

Openingsdemping: Ja

Sluitvertraging: Ja

Type arm: Glijarm

Openingshoek: 180°

I 377150033 IS 315 MET GLIJARM ZILVER

I 376010003 Montage plaat IS315

I 370031000 VASTZET MECHANIEK GLIJARM

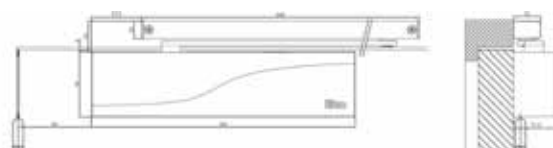
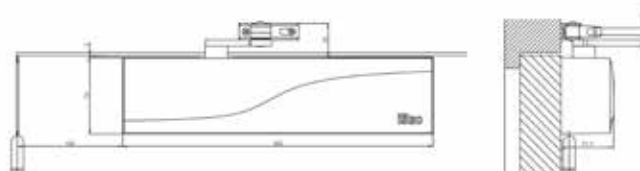

253

your world safely locked //®

# Iseo Is315RV

Zware deurdranger

## Iseo IS315RV

Max. deurbreedte: 1250mm

Max. deurgewicht: 120kg

Kleur: Zilver

Kracht: 3-5

Openingsdemping: Ja

Sluitvertraging: Ja

Type arm: Glijarm

Openingshoek: 180°

I 377150133 IS 315 MET GLIJARM ZILVER

I 376010003 Montage plaat IS315

I 370031000 VASTZET MECHANIEK GLIJARM



254

# Iseo Opbouwsloten



your world safely locked //®

Versie v1.1.2



**Dombrecht**  
DISTRIBUTION



## Oplegsloten

# 258

### 258. City 25

Oplegslot Knop / cilinder

### 258. City 26

Oplegslot Dubbele cilinder

### 259. Arnov

Oplegslot met europrofiel cilinder

257



# Iseo City 25 - 26

Opbouwslot

## Iseo City 25 Knop-Cilinder

Slot en sluitplaat in gestampt plaatstaal  
 Cilinder in koper 23mm doorsnede, 5 stiften  
 Geleverd met 3 sleutels  
 Staalschoot: 110x 38x 9mm  
 Sluitlengte: 37mm  
 Anti-afbraakbeveiligingspin

## Iseo City 26

Zelfde eigenschap als city 26  
 Maar met cilinder binnen en buitenkant

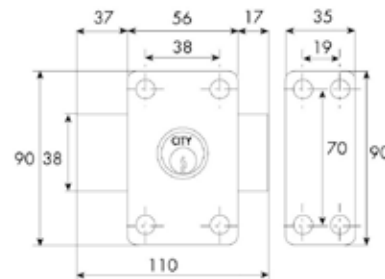
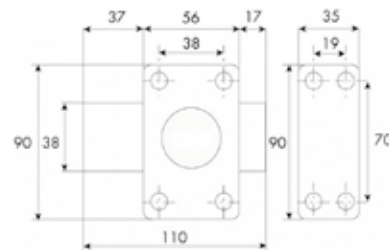

### City 25

C 10020401B	CITY 25 KN/CIL 40 WIT
C 10020451	CITY 25 KN/CIL 45 BRONS
C 10020451A	CITY 25 KN/CIL 45 ANTHRACITE
C 10020451B	CITY 25 KN/CIL 45 WIT
C 10020451M	CITY 25 KN/CIL 45 MARRON
C 10020501	CITY 25 KN/CIL 50 BRONS
C 10020501B	CITY 25 KN/CIL 50 WIT
C 10020601	CITY 25 KN/CIL 60 BRONS
C 10020601B	CITY 25 KN/CIL 60 WIT

### City 26

C 10022401	CITY 26 CIL/CIL 40 BRONS
C 10022451	CITY 26 CIL/CIL 45 BRONS
C 10022451B	CITY 26 CIL/CIL 45 WIT
C 10022501	CITY 26 CIL/CIL 50 BRONS
C 10022601	CITY 26 CIL/CIL 60 BRONS
C 10022601B	CITY 26 CIL/CIL 60 WIT

258

# Iseo Arnov

Opbouwslot met profiel cilinder

## Oplegslot voorzien voor europrofielcilinder

Slot en sluitplaat in gestampt plaatstaal 20/10  
 Voorzien voor profielcilinder, niet meegeleverd  
 Doornmaat: 45 - 60mm  
 Staalschoot: 110 mm  
 Sluitlengte: 34mm  
 Geleverd met bevestigingsvijzen  
 Gepatenteerd mechanisme



### Arnov

C 1005EU01	ARNOV 45 PZ BRONS
C 1005EU01A	ARNOV 45 PZ ANTHRACITE
C 1005EU01B	ARNOV 45 PZ WIT
C 1005EU01M	ARNOV 45 PZ MARRON
C 1005EU10	ARNOV 60 PZ BRONS
C 1005EU10A	ARNOV 60 PZ ANTHRACITE
C 1005EU10B	ARNOV 60 PZ WIT
C 1005EU10M	ARNOV 60 PZ MARRON

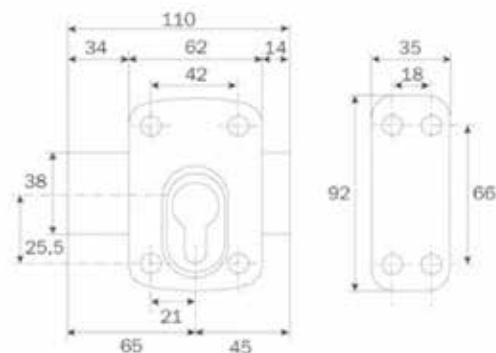

259



**Dombrecht**  
DISTRIBUTION

your world safely locked //®

Versie v1.1.2

# Iseo Anti-paniek



your world safely locked //®

Versie v1.1.2



**Dombrecht**  
DISTRIBUTION



## Nooduitgangen volgens norm

EN 179:2008

Is van toepassing voor uitgangen in gebouwen waar geen openlijk publieksverkeer aanwezig is en de aanwezigen de functie van de vluchtdeuren kennen.

Het kan hier bijvoorbeeld gaan over nevenuitgangen in openbare gebouwen, die enkel door bevoegde personen (bijvoorbeeld personeel) benut mogen worden of bijvoorbeeld kantoorgebouwen.

De keuze van de beslagelementen blijft beperkt tot krukken, push-pads.



EN 1125:2008

Komen voor in gebouwen, waarbij de bezoekers de functie van de vluchtdeuren niet kennen en deze in noodsituaties zonder instructies moeten kunnen bedienen. (openbare gebouwen, bioscopen, ...)

De keuze van de beslagelementen beperkt zich tot panieksluitingen die aan zekere voorschriften moeten voldoen teneinde een langdurige en feilloze werking te waarborgen.



Hoe wordt de norm EN 1125:2008 weergegeven?

Niet geschikt	3	7	6	0	1	4	2	2	A	A
Geschikt	3	7	6	B	1	4	2	2	A	A
Gebruik in paniekdeuren:	gebruikers- categorie	Duurzaamheid	Deurgewicht	Brandwerendheid	Veiligheid	Corrosie- bestendigheid	Inbraak- veiligheid	Afstand stang of balk	Type werking	Toepassing

Gebruikerscategorie	Er is slechts 1 categorie die refereert naar veelvuldig gebruik zonder dat men is ingelicht over de werking van de vluchtdeur
Duurzaamheid	graad 6 = 100.000 cycli graad 7 = 200.000 cycli
Deurgewicht	graad 5 = voor deuren tot een gewicht van max. 100 kg graad 6 = voor deuren tot een gewicht van max. 200 kg graad 7 = voor deuren meer dan 200 kg
Brandwerendheid	0 = ongeschikt voor rook- en brandwerende deuren A = geschikt voor rookwerende deuren B = geschikt voor rook- en brandwerende deuren
Veiligheid	1= alleen de hoogste veiligheid wordt als Europees standaard geaccepteerd
Corrosiebestendigheid (EN 1670)	graad 3 = 96 uur hoog graad 4 = 240 uur zeer hoog
Inbraakveiligheid	Er is slechts 1 graad van veiligheid die hiernaar refereert, de veiligheid van personen primeert op veiligheid van goederen.
Afstand stang of balk tot deurblad	graad 1 = tot max. 150 mm graad 2 = tot max. 100 mm
Type werking	A = met Base (duwstang) B = met Push (duwbalk)
Toepassing	A = enkele of dubbele deur , en zowel actieve als passieve deur B = alleen geschikt voor enkele deuren C = alleen geschikt voor passieve deur bij dubbele deuren





**Dombrecht**  
DISTRIBUTION

your world safely locked //®

Versie v1.1.2

## Iseo Base

# 266

### 266. Base

Duwbar met schotensluiting

### 269. Base Inox

Duwbar in inox

### 272. Base voor insteeksloten

Voor insteeksloten

### 273. Onderdelen en benodigdheden

## Iseo Bolt

# 275

### 275. Bolt

Duwbar met pinsluiting

### 276. Bolt inox

Duwbar in inox

### 277. Onderdelen en benodigdheden

## Iseo Push

# 278

### 278. Push

Sluiting met schoten

### 279. Push Bolt

Sluiting met pinnen

### 280. Push Palmo

Pushbalk voor insteeksloten

### 281. Onderdelen en benodigdheden

## Beslag en accessoires

# 283

### 283. Trim

Buitenmodule

### 283. Trim Tronic

Elektronische buitenmodule

### 284. Onderdelen en benodigdheden

### 287. Insteeksloten voor anti-paniek

# Iseo Base

Duwbar met schotensluiting

## Duwbar met schotensluiting

Voldoet aan de Europese norm EN 1125:2008  
 Modulair: opbouw naar 2 of 3 punt versie mogelijk  
 Afkortbaar op maat van de deur  
 Stalen schoot met blokeringsmechanisme  
 Geschikt voor branddeuren  
 Keerbaar  
 antibacteriële coating ISO 22196

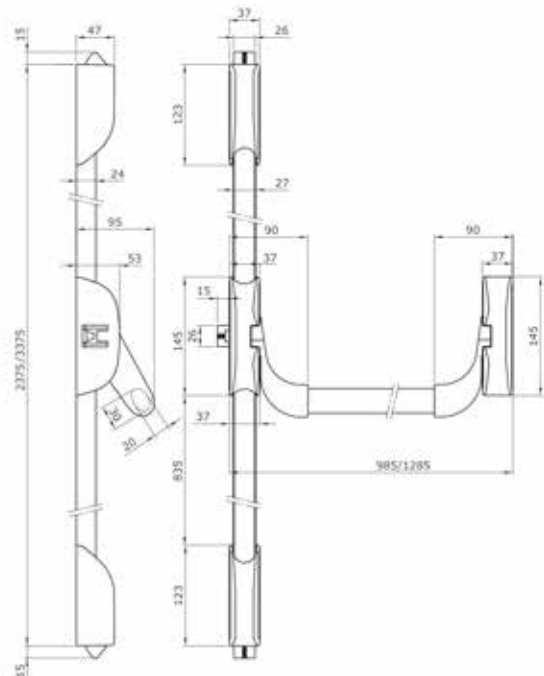
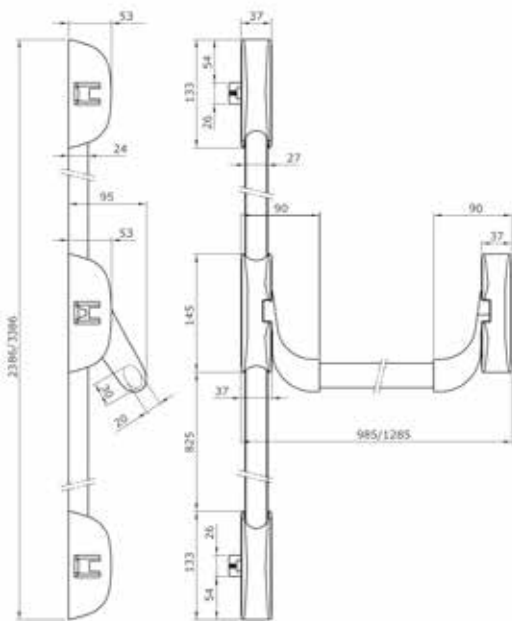
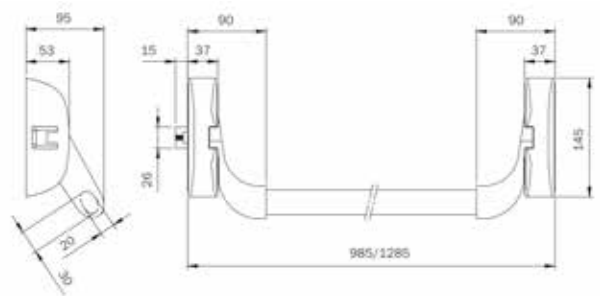

266



**IDEA Base steel latches: application scheme for single leaf doors**

9412000505		(A) (B)	(A) (B)	(A) (B)			
9414000*04	●	●	●	●	●	●	●
9410201*04		●			●		
9410204*04				●			●
9410203*04			●			●	
94591* L = 830 94592* L = 1130 94593* L = 1330	* ●	* ●	* ●	* ●	* ●	* ●	* ●
9410020* 9410030*		* ●	* ●	* ●	* ●	* ●	* ●
56800**	○		○○	○○		○○○	○○○
9401100*T 9401101*T 9401200*T 9401300*T 9401400*T 9401500*T 9402100*T 9402102*	* ○	* ○	* ○	* ○	* ○	* ○	* ○
9409110*E							
94100060	○	○	○	○	○	○	○
94100040	○○	○○	○○	○○	○○	○○	○○
94100050		○○	○○	○○	○○	○○	○○
94100070	○	○	○	○	○	○	○

(A) (B) = Choice among proposed options as shown above  
 ● = Necessary items ( ●● = 2 pcs, ●●●● = 3 pcs)  
 \* = Choose one item only  
 ○ = Optional items ( ○○ = 2 pcs, ○○○○ = 3 pcs)





## IDEA Base steel latches: application scheme for double doors

9414000*04		(A) ● (B) ●●	(A) ●● (B) ●●	(A) ● (B) ●●	(A) ● (B) ●●
9412000505		●	●●	●	●●
9410201*04		●	●	●	●●
9410204*04					
9410203*04			●	●	
94591* L = 830 94592* L = 1130 94593* L = 1330		* ●●	* ●●	* ●●	* ●●
9410020* 9410030*		* ●	* ●●	* ●●	* ●●
56800**		△	△△	△△△	
9401100*T 9401101*T 9401200*T 9401300*T 9401400*T 9401500*T 9402100*T 9402102*		* ○	* ○	* ○	* ○
9409110*E					
94100060		○○	○○	○○	○○
94100040		○○○○	○○○○	○○○○	○○○○
94100050		○○	○○○○	○○○○	○○
94100070		○○	○○	○○	○○

(A) (B) = Choice among proposed options as shown above  
 ● = Necessary items ( ●● = 2 pcs, ●●● = 3 pcs)  
 \* = Choose one item only  
 ○ = Optional items ( ○○ = 2 pcs, ○○○ = 3 pcs)  
 △ = The type of installation depends on the door frame ( △△ = 2 pcs, △△△ = 3 pcs)

# Iseo Base inox

Duwbar met schotensluiting inox uitvoering

## Duwbar mer schotensluiting

Inox uitvoering  
 Voldoet aan de Europese norm EN 1125:2008  
 Modulaair: opbouw naar 2 of 3 punt versie mogelijk  
 Afkortbaar op maat van de deur  
 Stalen schoot met blokeringsmechanisme  
 Geschikt voor branddeuren  
 Keerbaar

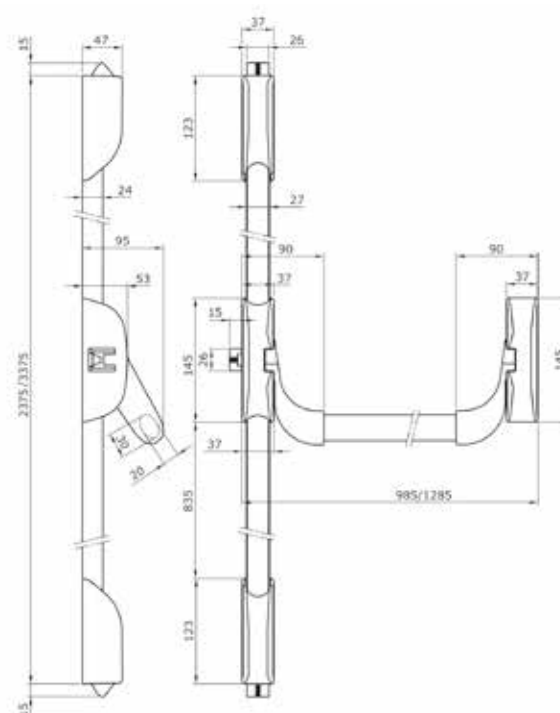
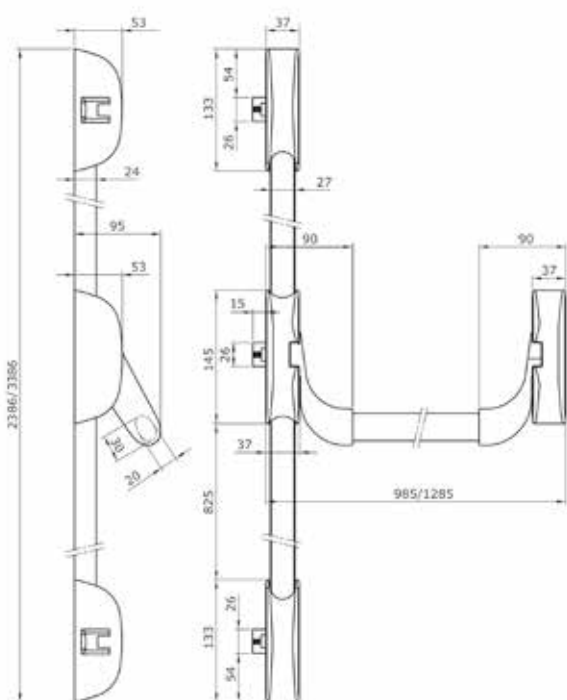
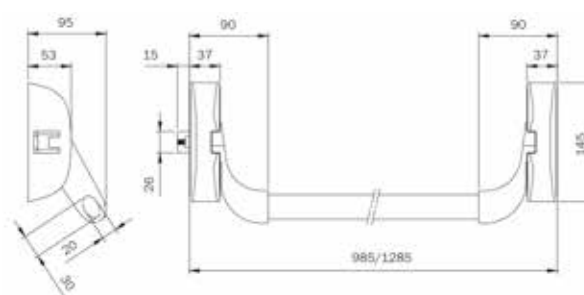

269

your world safely locked //®





## IDEA Base PVD - Inox: application scheme for single leaf doors

9414000524	●	●	●	●	●	●	●	●
9410201524		●			●			
9410204524				●				●
9410203524			●			●		
945922 L = 1130 945932 L = 1330	* ●	* ●	* ●	* ●	* ●	* ●	* ●	* ●
94100202 94100302		* ●	* ●	* ●	* ●	* ●	* ●	* ●
56800** 5680012	○		○ ○	○ ○		○ ○ ○		
94011002T 94021002	* ○	* ○	* ○	* ○	* ○	* ○	* ○	* ○
94012002T								
94100060	○	○	○	○	○	○	○	○
94100070	○	○	○	○	○	○	○	○

● = Necessary items (●● = 2 pcs, ●●● = 3 pcs)  
 \* = Choose one item only  
 ○ = Optional items (○○ = 2 pcs, ○○○ = 3 pcs)



**IDEA Base PVD - Inox: application scheme for double doors**

9414000524		● ●	● ●	● ●	● ●
9410201524		●	●	●	● ●
9410204524					
9410203524			●	●	
945922 L = 1130 945932 L = 1330		* ● ●	* ● ●	* ● ●	* ● ●
94100202 94100302		* ●	* ● ●	* ● ●	* ● ●
56800** 5680012		△	△ △	△ △ △	
94011002T 94021002		* ○	* ○	* ○	* ○
94012002T					
94100060		○ ○	○ ○	○ ○	○ ○
94100070		○ ○	○ ○	○ ○	○ ○

- = Necessary items (● ● = 2 pcs, ● ● ● = 3 pcs)
- \* = Choose one item only
- = Optional items (○ ○ = 2 pcs, ○ ○ ○ = 3 pcs)
- △ = The type of installation depends on the door frame (△ △ = 2 pcs, △ △ △ = 3 pcs)

# Iseo Base

Voor insteeksloten

## Duwbalk voor insteeksloten

Paniekbaar toepasbaar op paniek insteeksloten  
Voldoet aan de Europese norm EN 1125:2008 in de door ISEO geteste combinatie  
Voor elke andere combinatie is de koper verantwoordelijke voor het al dan niet respecteren van de Europese norm Keerbaar  
Krukstift niet meegeleverd (I 947930)  
Horizontale duwstang niet bijgeleverd  
antibacteriële coating ISO 22196



272



**Iseo Base - Base inox**



I 9414000504 PANIEKSL MODULAIR IDEA ZWART



I 9410201504 SET VERT. SCHOTEN VOOR PANIEKS ZWART



I 9410203504 SET HOR. SCHOTEN VOOR PANIEKSL ZWART



I 9410003504 HORIZONTALE SCHOOT VOOR PANIEK ZWART



I 9410204504 SET VERT+HORIZ SCHOTEN PANIEKS ZWART



I 945928 RODE DUWBAAR 1130MM VOOR IDEA



I 945938 RODE DUWBAAR 1330MM IDEA PANIEK



I 94100205 STANGEN 2400 MM VOOR PANIEKSL.



I 94100305 STANGEN 3400 MM VOOR PANIEKSL.



I 9414000524 PANIEKSLUITING MODULAIR IDEA I



I 9410203524 SET HOR. SCHOTEN VOOR IDEA INO



I 9410201524 SET VERT. SCHOTEN VOOR IDEA IN

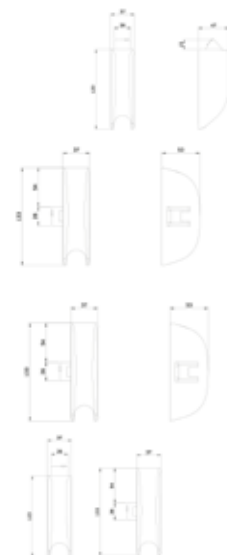

**Iseo Base - Base inox**

---



I 945922 STANG 1130MM VOOR IDEA INOX

---

I 945932 STANG 1330MM VOOR IDEA INOX

---



I 94100202 STANGEN 2400 MM VOOR IDEA INOX

---



I 94100302 STANGEN 3400 MM VOOR IDEA INOX

---



I 94C000050379 BASE VR INSTEKSLATEN 72MM 30°

---



I 949000020379 PALMO VR BRANDD 72MM 30° INOX

---

# Iseo Bolt

Duwbar met pinsluiting

## Duwbar met pinsluiting

Voldoet aan de Europese norm EN 1125:2008

Keerbaar

Stevige metalen sluitpinnen: Inbraakwerend, zelfroterend, 14mm diameter, zelfsluitend.

Zolang de deur open staat blijven de metalen pinnen ingestrokken, als de deur dicht valt, sluiten de pinnen automatisch door contact met de sluitplaat ( gepatenteerd systeem).

Sluitingen boven en onder regelbaar, zonder opstaande bodemsluitplaatjes, maar met stofwerende vloersokkel

Gemakkelijke installatie

Toepasbaar op alle type deuren

Keerbaar

Verbindingsstangen en duwbar apart te bestellen  
antibacteriële coating ISO 22196

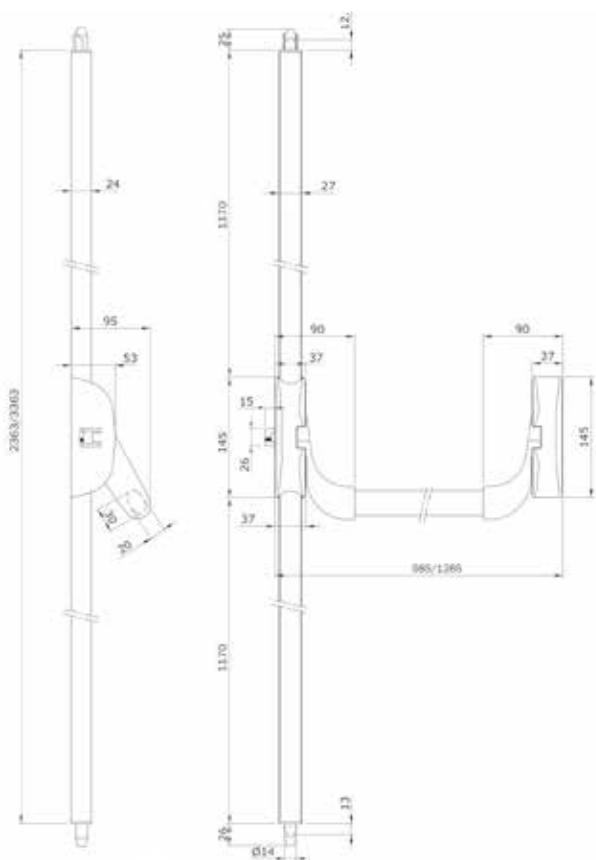
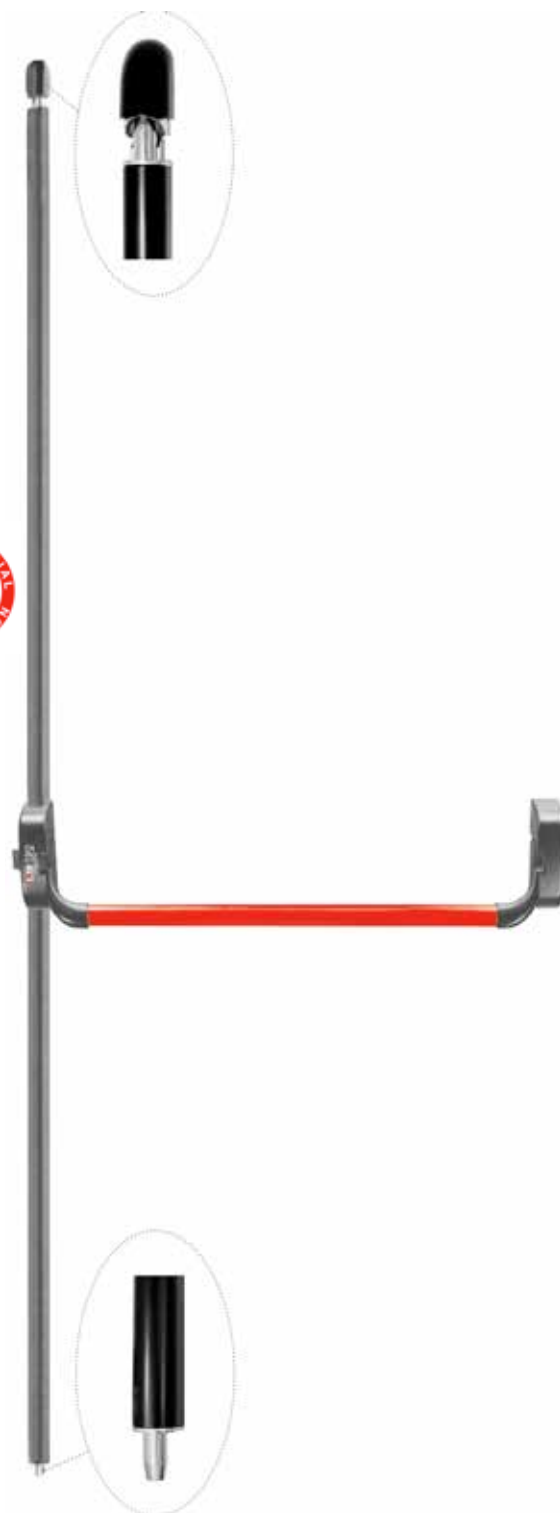

275

your world safely locked //®



# Iseo Bolt inox

Duwbar met pinsluiting inox uitvoering

## Duwbar met pinsluiting

Uitvoering in Inox

Voldoet aan de Europese norm EN 1125:2008

Keerbaar

Stevige metalen sluitpinnen: Inbraakwerend, zelfroterend, 14mm diameter, zelfsluitend.

Zolang de deur open staat blijven de metalen pinnen ingestrokken, als de deur dicht valt, sluiten de pinnen automatisch door contact met de sluitplaat ( gepatenteerd systeem).

Sluitingen boven en onder regelbaar, zonder opstaande bodemsluitplaatjes, maar met stofwerende vloersokkel

Gemakkelijke installatie

Toepasbaar op alle type deuren

Keerbaar

Verbindingsstangen en duwbar apart te bestellen

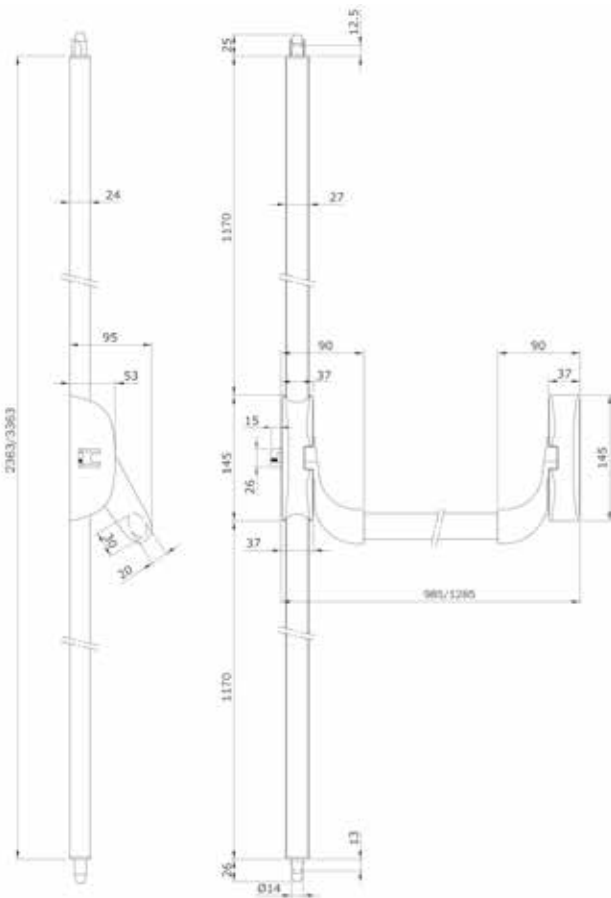
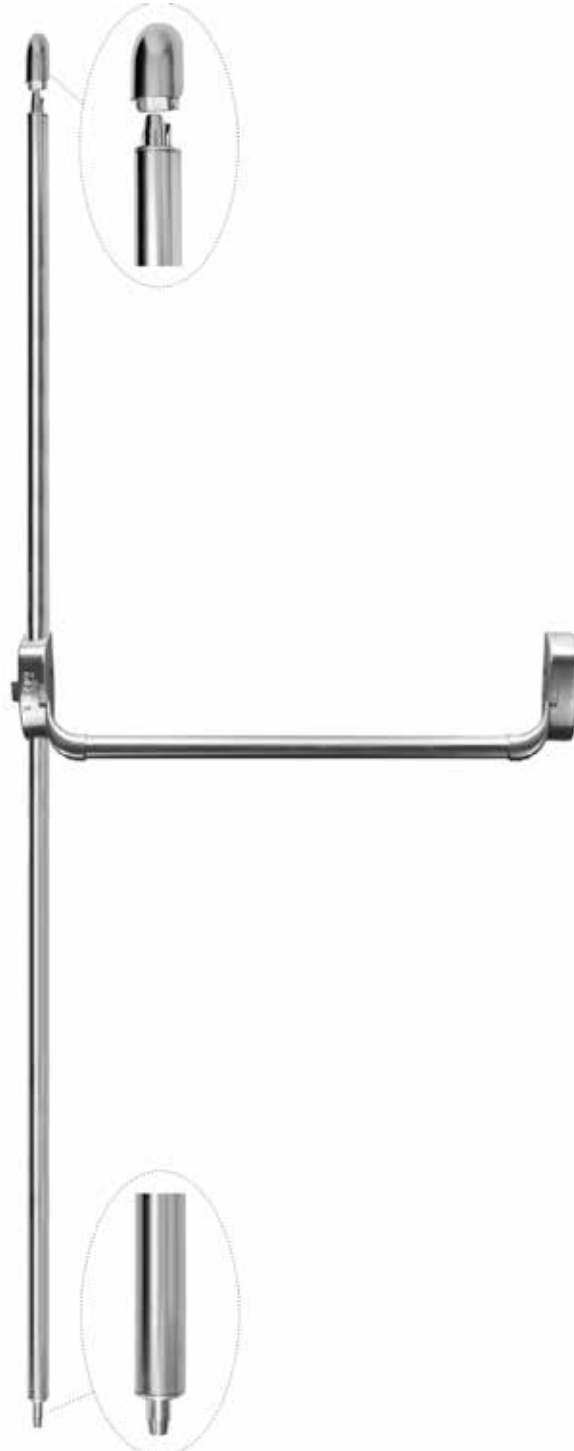

276



## Iseo Bolt - Bolt inox

	I 9433000224	IDEA -BOLT 3-PT INOX VERT.SC
	I 9433000504	IDEA -BOLT 3-PT ZW VERT.SC
	I 9432000504	IDEA-BOLT 2-PT ZW VERT.SC
	I 94300202	STANG INOX 2400MM IDEA PUSH-BO
	I 94300302	STANGEN INOX 3400 MM IDEA BOL
	I 945922	STANG 1130MM VOOR IDEA INOX
	I 945932	STANG 1330MM VOOR IDEA INOX
	I 94300205	STANGEN ZWART 2400MM IDEA PUSH-BO
	I 945924	WITTE DUWBAAR 1130MM IDEA
	I 945925	ZWARTE DUWBAAR 1130MM VR IDEA
	I 945928	RODE DUWBAAR 1130MM VOOR IDEA
	I 945937	METAAL GRIJS DUWBAAR 1330MM
	I 945938	RODE DUWBAAR 1330MM IDEA PANIEK

# Iseo Push

Pushbalk met schoten

## Pushbalk met schoten

Voldoet aan de Europese norm EN 1125:2008  
Modulair: opbouw naar 2 of 3 puntsluiting mogelijk  
Afkortbaar op maat van de deur tot 330mm  
Stalen schoot met blokkeringsmechanisme geschikt voor branddeuren.  
Keerbaar  
antibacteriële coating ISO 22196

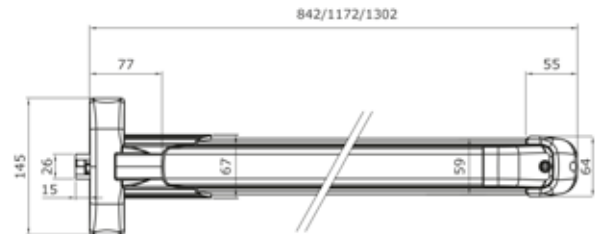

278

# Iseo Push bolt

Pushbalk met pinsluiting

## Pushbalk met pinsluiting

Voldoet aan de Europese norm EN 1125:2008  
 Keerbaar  
 Pushbar afkortbaar tot 330mm  
 Staalschoot  
 Inclusief sluitplaten  
 Stangen voor onder en boven - apart te bestellen  
 Vloersokkel apart te bestellen  
 antibacteriële coating ISO 22196

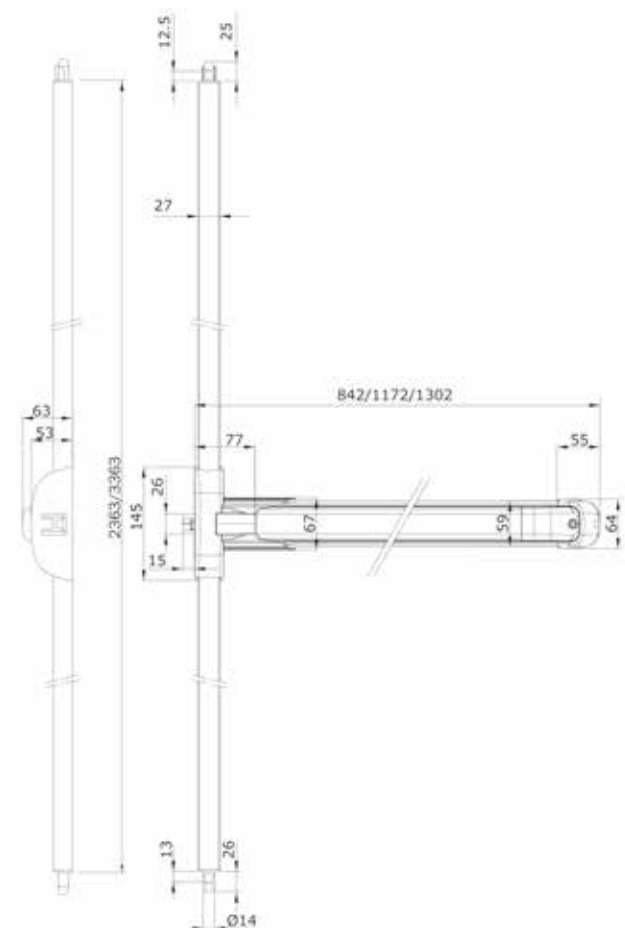

279

your world safely locked //®



# Iseo Push palmo

Pushbalk voor insteeksloten

## Pushbalk voor insteeksloten

Voldoet aan de Europese norm EN 1125:2008 in de door ISEO geteste combinatie

Voor elke andere combinatie is de koper verantwoordelijke voor het al dan niet respecteren van de Europese norm Paniekbaar toepasbaar op paniek sloten

Inkortbaar tot 330mm

Kurkstift niet meegeleverd (I 947930)

Compatibel met insteekslot serie I 2141\*  
antibacteriële coating ISO 22196



280



## Iseo Push - Push Palmo



I 942408458T IDEA-PUSH BAR MODULAIR 840MM ROOD

I 942411758T IDEA-PUSH MODULAIR 1170 MM ROOD



I 942413058T IDEA-PUSH BAR MODULAIR 1300 MM



I 9453084584 IDEA PUSH-BOLT 840MM R/ZW 3-PT

I 9453117584 IDEA PUSH-BOLT 1170MM R/ZW 3-P

I 9453130584 IDEA PUSH-BOLT 1300MM R/ZW 3-P

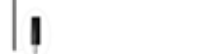
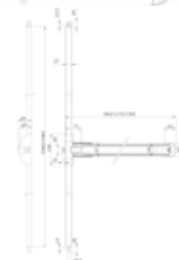

I 9452084584 IDEA PUSH-BOLT 840MM R/ZW 2-PT

I 9452117584 IDEA PUSH-BOLT 1170MM R/Z 2-PT

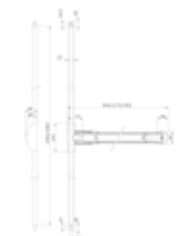

I 944408458T PUSH BAR MODULAIR 840MM ROOD

I 944411758 PUSH BAR MODULAIR 1170 MM ROOD



I 94490815829 PUSH PALMO INST.SL. 72/92 811 MET CIL GAT

I 94490815839 PUSH PALMO SL. 72/92 811/9MM ZONDER CIL

I 94491165829 PUSH PALMO INST.SL.72/92 1161 MET CIL GAT

I 94491165839 PUSH PALMO INST.SL.72/92 1161 ZONDER CIL GAT



I 94100202 STANGEN 2400 MM VOOR IDEA INOX



## Iseo Push - Push Palmo



I 94100205 STANGEN 2400 MM VOOR PANIEKSL.

I 94100207 STANGEN METAAL GRIJS 2400 MM PANIEKSL



I 94100302 STANGEN 3400 MM VOOR IDEA INOX



I 94100305 STANGEN 3400 MM VOOR PANIEKSL.



I 94300205 STANGEN ZWART 2400MM IDEA PUSH-BO

I 94300305 STANGEN ZWART 3400 MM IDEA BOL



I 94402005 STANGEN 2265MM VOOR PUSH BAR



I 94402015 STANGEN 3200 MM VOOR PUSH BAR



I 9410203504 SET HOR. SCHOTEN VOOR PANIEKSL ZWART



I 9410204504 SET VERT+HORIZ SCHOTEN PANIEKS ZWART



I 94200095 KIT ALARM PUSH SIRENA



# Iseo Trim Series

Buitenmodule

## Iseo Trim

Buitenmodules voor de Iseo Anti-panieksluitingen  
 Geschikt voor Base, Push en Bolt  
 Voorzien van een halfprofielcilinder type F5 ( verwisselbaar)  
 Voor een deurdikte tot 105mm

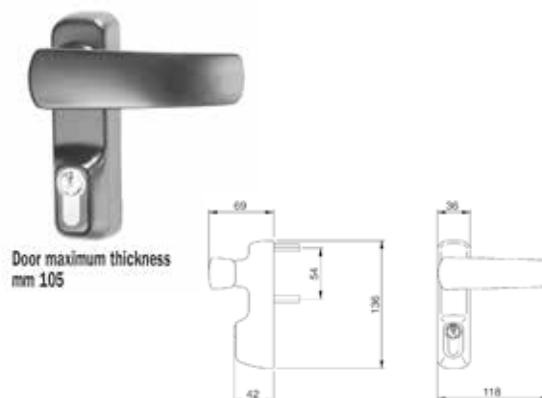

## Iseo Trim Tronic Elektronische buiten module

Speciaal voor anti-panieksluitingen  
 Geschikt voor Base, Push en Bolt  
 Voorzien van half-profielcilinder type R6 ( verwisselbaar)  
 De kruk wordt ontgrendeld door elektrische impuls  
 2 leds die de status van de kruk aangeven  
 Kruk is ook mechanische te bedienen via de cilinder

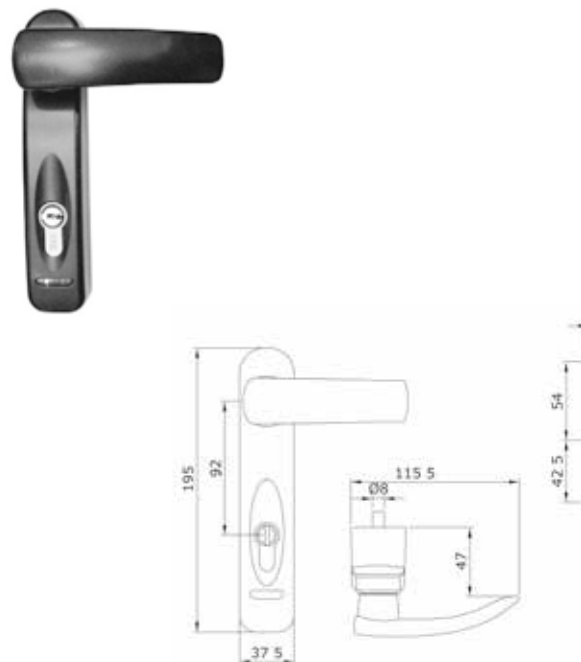

283



## Iseo Trim - Trim Tronic



I 94091105E TRIM-TRONIC ZWART MODULE

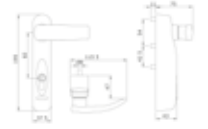

I 94011002T KRUK-CIL. VOOR SERIE IDEA INOX



I 94011004T KRUK-CIL.SERIE 941 EN 94 WIT

I 94011005T KRUK-CIL. VOOR SERIE 941 EN 94

I 94011007T KRUK-CIL. VOOR 941 EN 944 GRIJS



I 94014005T KRUK VOOR SERIE 941 EN 944 ZWART



I 94012002T KN-CIL SERIE 941 EN 944 INOX

I 94012003T KN-CIL SERIE 941 EN 944 GRIJS

I 94012005T KN-CIL SERIE 941 EN 944 ZWART



I 94013003T CIL-VASTE KN SERIE 941 GRIJS

I 94013005T CIL-VASTE KN SERIE 941 ZWART



I 94021005 KRUK-CIL. VOOR 941 EN 94 124MM



I 94021025 KRUK-CIL. 941 EN 94 OVALE GRE



I 859000857 OPLEGCIL. ISR5 KOPER

I 859000857.5DD OPLEGCIL. ISR5 KOPER KA

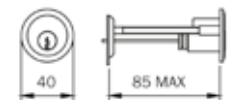

I 94403000E VOEDING 230V AC - 12V DC - 3A



I 94403010E KABELGELEIDER EXT 300 MM

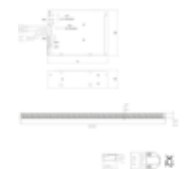

I 94403020E KABEL 0,3M TRIM - PUSH TRONIC

I 94403030E KABEL 0,5M TRIM - PUSH TRONIC



I 94403110E KABELGELEIDER INT 300 MM





## Iseo Anti paniek onderdelen



I 5680000 DEUROPENER ANTI-PAN 12V NA IMPULS ZWART

I 5680003 DEUROPENER ANTI-PAN 12V NA IMPULS GRIJS

I 5680020 EL. OPENER ZWART ANTI-PAN 24 VOLT

I 5680023 EL. OPENER ANTI-PAN GRIJS 12V



I 5680012 AFDEKKAP PVD VR SERIE 56800\*



I 94100145 SLUITPLAAT VR IDEA 3MM 45°



I 94100100 SLUITPLAAT BASE EN PUSH ZWART



I 94100110 SLUITPLAAT BOVEN/HOR IDEA ZWART

I 94100112 SLUITPLAAT BASE INOX

I 94100113 SLUITPLAAT BOVEN VERTIK GRIJS

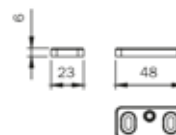

I 94100120 SLUITPLAAT ONDER VOOR IDEA ZWART

I 94100123 SLUITPLAAT ONDER VOOR IDEA GRIJS

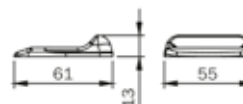
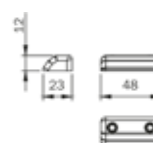

I 94100130 SLUITPLAAT VR IDEA TOT 11MM ZWART

I 94100132 SLUITPLAAT VR IDEA TOT 11MM PVD

I 94100137 SLUITPLAAT VR IDEA TOT 11MM GRIJS

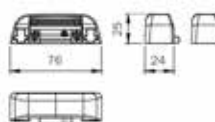

I 94100150 SLUITPLAAT VR IDEA 14MM-24MM



I 94100090 REGELBARE SLUITPLAAT VR PANIEK  
25\*58.5\*19MM

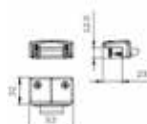

285

**Iseo Anti paniek onderdelen**

I 040807 VLOER SOKKEL VOOR PUSH-BOLT



I 94100655 SET RENOVATIEPL. VR ANTI-PANIE



I 94000030 PAKKING VOOR BRANDDEUREN



I 94100070 KIT FERMO BASE EN BOLT



I 94200075 HOLD OPEN VR IDEA PUSH



I 947880 VERLENGDE VIERKANTSTIFT 105 MM



I 94100060 KIT MICROSWITCH IDEA BASE+BOLT



I 94200060 KIT MICROSWITCH IDEA PUSH



I 94800030 KIT MICROSWITCH PUSH-BAR



I 94400030 KIT MICROSWITCH PUSH PALMO

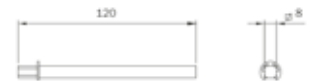
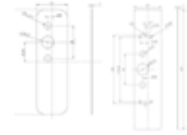



## Iseo Anti paniek onderdelen



I 216120654 PANIEKSLOT DAG+NACHT

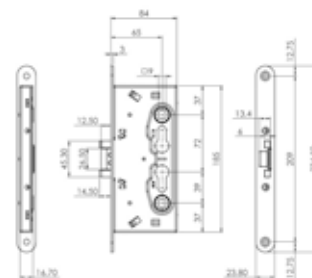

I 214910654D PANIEKSLS PALMO KRUK ELEC Din R

I 214910654S PANIEKSLS PALMO KRUK ELEC Din L

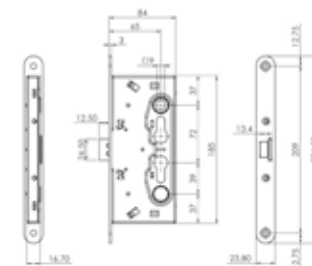

I 214110654 PANIEKSLOT 65MM PALMO EXT KRUK

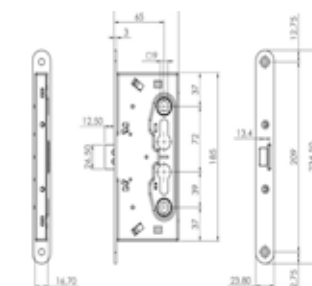

I 214140654 PANIEKSLOT 65MM PALMO EXT KNOP

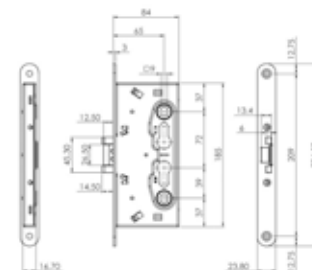

I 214120654 PANIEKSLOT 65MM PALMO EXT KRUK

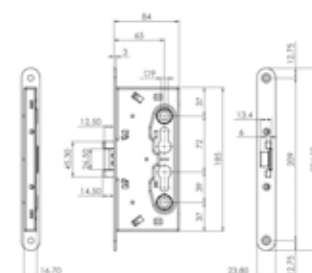

I 212600654 PANIEK TEGENSL 65MM PALMO 2KRN

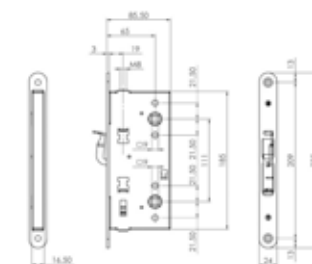



## Iseo Anti paniek onderdelen



I 032094 TEGENPLATEN VOOR SERIE 214654



I 032144 DEBLOKKEERSYSTEEM VR PALMO

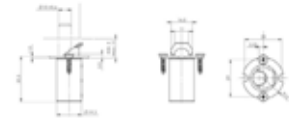

I 032714 UITVULPLAATJE 1 MM

I 032724 UITVULPLAATJE 2 MM



I 032154 BOVENSLUITSTUK



I 032164 VLOERSOKKEL

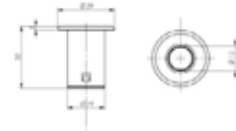

I 032174 GELEIDINGSTUK



I 032184 STANGENSET VOOR FLUSH BOLT





## Iseo Anti paniek Beslag



I 032435 BESLAG PALMO KRUK ZWART

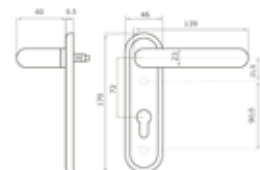

I 032415 BESLAG PALMO KR-KR ZWART

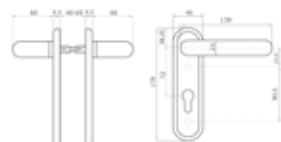

I 032465 BESLAG PALMO KNOP ZWART

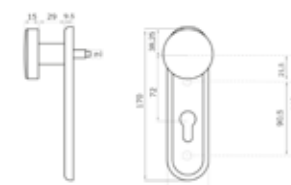

I 032425 BESLAG PALMO KNOP ZONDER PZ

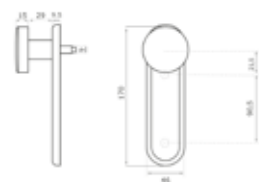

I 032402 BESLAG PALMO KN-KR INOX

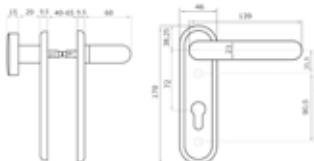

I 947900 VIERKANTSTIFT 125MM DIA 9MM



I 947910 VIERKANTSTIFT 2 DELIG 55/38 MM

I 947920 VIERKANTSTIFT 2-DELIG 55/55MM



I 947930 VIERKANTSTIFT 62 MM DIA 9MM





# Deurmagneten



your world safely locked //®

Versie v1.1.2



**Dombrecht**  
DISTRIBUTION



**Dorcas Deurmagneten**

**Deurmagneten**

DOR M11	MAGNEET INBOUW 3000N
DOR M22	MAGNEET OPBOUW 5000N
DOR M2222	MAGNEET OPBOUW 10000N M66
DOR M33	MAGNEET OPBOUW 3000N

**Montage platen**

DOR L2	MONTAGEPLAAT VOOR M22
DOR L22	VOORPL. KEERBAAR EL.OP 22MM
DOR L3	MONTAGEPLAAT VOOR M33
DOR Z	MONTAGEPLAAT UNIV. VR M22,M33
DOR U	MONTAGEPLAAT VR MAGNEET GLASDEUR

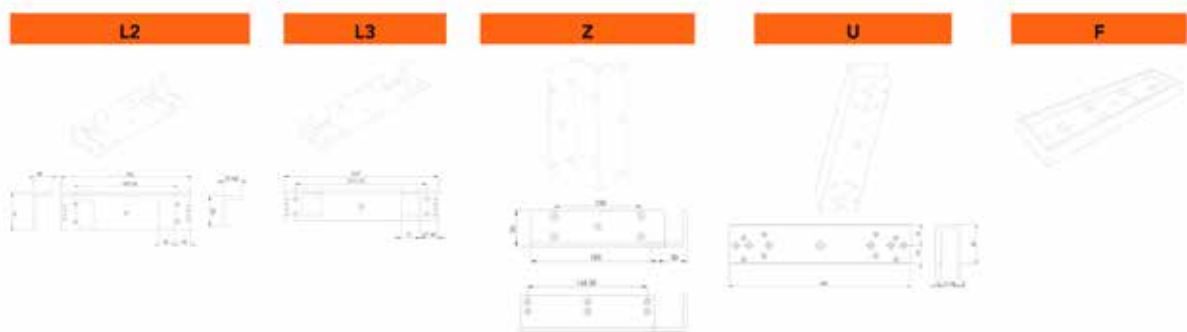

	M11	M33	M22
Hoogte	228 mm	254 mm	273 mm
Breedte	39 mm	43 mm	67 mm
Diepte	27 mm	25 mm	40 mm
Kracht	300 Kg	300 Kg	500 Kg
Signaal	Reed+Led	Reed+Led	Reed+Led
Voeding	12/24 Vdc	12/24 Vdc	12/24 Vdc

292



**Dorcas Deurmagneten**

**Magneet voor branddeuren**

DOR PRF20T24	VLOERMAGN BRANDDR 20KG 24VDC
DOR PRF20T48	VLOERMAGN BRANDDR 20KG 48VDC
DOR PRF50T24	VLOERMAGN BRANDDR 50KG 24VDC
DOR PRF50T48	VLOERMAGN BRANDDR 50KG 48VDC
DOR R20T24	MAGNEET BRANDDR 20KG 24VDC
DOR R20T48	MAGNEET BRANDDR 20KG 48VDC
DOR R50T24	MAGNEET BRANDDR 50KG 24VDC
DOR R50T48	MAGNEET BRANDDR 50KG 48VDC

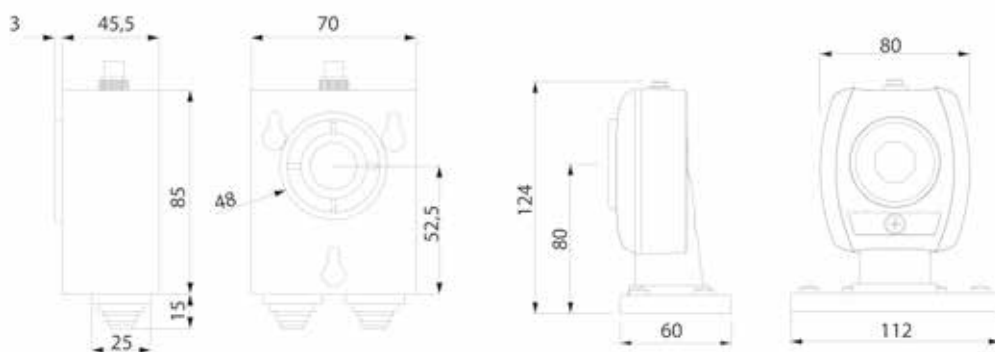

	RT20		RT50		PRT20		PRT50	
Hoogte	85 mm		85 mm		124 mm		124 mm	
Breedte	70 mm		70 mm		112 mm		112 mm	
Diepte	45,5 mm		45,5 mm		60 mm		60 mm	
Kracht	20 Kg		50 Kg		20 Kg		50 Kg	
Voeding	24 Vdc	48 Vdc	24 Vdc	48 Vdc	24 Vdc	48 Vdc	24 Vdc	48 Vdc
Verbruik (mA)	24	24	80	48	24	24	80	48

**293**

# Dorcac Profast

Deurbalk met magneet

Profast-systeem is een nieuw product gemaakt met twee aluminium profielen, één gemonteerd in de deur en het andere in het kozijn. In beide zijn elektromagneten geïnstalleerd. Het systeem opent via de ingebouwde deurklink en wanneer het sluit, blijft het profiel met de velgvergrendelingen volledig verborgen.

De installatie van dit systeem is voorbereid om snel en eenvoudig te zijn (10 minuten) en de afwerking is volledig modern en esthetisch met verborgen kabels in de profielen. Deze oplossing is geschikt voor kantoren, winkels, openbare gebouwen, enz. en voor alle soorten deuren (hout, metaal en glas) en kan werken van 12 tot 48V, waardoor de installatie een retentiekraft tot 600 kg heeft.

DOR PF1 PROFAST OPBOUW MAGNEET

Lengte	2190 / 2500 mm
Breedte	105 mm
Diepte	63 mm
	12 / 24 / 48 Vdc
Kracht	2 x 300 Kg
Voeding	550 (por cierre) 275 (por cierre)
Verbruik	190 (los dos cierres)

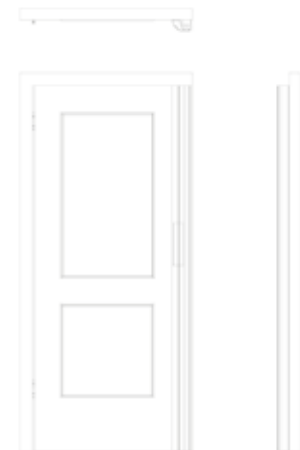

# Sleutelkluisjes



your world safely locked //®

Versie v1.1.2

Info@dombrecht.eu www.dombrecht.eu  
Tel: 052/44 74 84 Fax: 052/44 90 52



**Dombrecht**  
DISTRIBUTION

# Sleutelkluisjes

## ML 5400-EURD

Middelgrote sleutelkluis met beugel 90mm.  
In vinyl beklede beugel voorkomt krassen.  
4 cijferige vrije combinatiekeuze

Buitenafmeting (h x b x d): 15,7cm x 9cm x 4cm  
Binnenafmeting (h x b x d): 7,4cm x 6,8cm x 3cm  
Beugelafmeting: 48mm breed x 37mm hoog



ML 5400 EURD

## ML 5401-EURD ML 5401-EURDCRM

Middelgrote sleutelkast om aan de muur te bevestigen.  
4 cijferige vrije combinatiekeuze  
83mm breed metalen huis  
(inclusief bevestigingskit)

Buitenafmeting (h x b x d): 11,9cm x 8,5cm x 3,6cm  
Binnenafmeting (h x b x d): 9,2cm x 6,4cm x 3cm



ML 5401-EURD

ML 5401-EURDCRM

## ML 5403-EURD

Extra grote sleutelkast om aan de muur te bevestigen.  
biedt plaats voor diverse huisleutels of toegangskaarten.  
4 cijferige vrije combinatiekeuze  
(inclusief bevestigingskit)

Buitenafmeting (h x b x d): 14,6cm x 10,6cm x 5,3cm  
Binnenafmeting (h x b x d): 11,2cm x 7,7cm x 4cm



ML 5403-EURD

# Sleutelkluisjes

## ML 5415-EURD

Grote sleutelkast met versterkte beveiliging om aan de muur te bevestigen.  
Dubbele blokkeerhendels voor betere weerstand  
Massief zinken huis  
4 cijferige vrije combinatiekeuze

Buitenafmeting (h x b x d): 13,2cm x 10,5cm x 4,3cm  
Binnenafmeting (h x b x d): 11,3cm x 6,4cm x 3,1cm

ML 5415-EURD



## ML 5425-EURD

Middelgrote sleutelkast om aan de muur te bevestigen  
Met oplichtende cijfers  
4 cijferige vrije combinatiekeuze  
Grote, gemakkelijk leesbare verlichte draaischijven die beter zichtbaar zijn, vooral als er weinig licht is  
(inclusief bevestigingskit)

Buitenafmeting (h x b x d): 12,6cm x 7,2cm x 5,2cm  
Binnenafmeting (h x b x d): 10,3cm x 5,7cm x 2,5cm

ML 5425-EURD



## ML 5426-EURD

Extra grote, gecertificeerde groepsvergrendelingskast voor sleutels om aan de muur te bevestigen  
(inclusief bevestigingskit)  
verzonken deurconstructie voor meer weerstand te bieden tegen openbreken met een koevoet

Buitenafmeting (h x b x d): 14,6cm x 10,6cm x 5,3cm  
Binnenafmeting (h x b x d): 11,2cm x 7,7cm x 4cm

ML 5426-EURD



# Sleutelkluisjes

## ML 5441-EURD

Bluetooth groepsvergrendelingskast

Grote opslagruimte voor sleutels biedt plaats aan diverse huissleutels of toegangskaarten

Openen en beheren met uw smartphone

Gebruik de GRATIS app Master Lock® Vault Home voor Android of IOS

Kan ook worden geopend door invoer van een gebruikelijke code via het toetsenpaneel

Plan toegang nu of in de toekomst

Verstrek permanente of tijdelijke toegang

Gebruik de app of het internet om gebruik te volgen

Waarschuwingen voor braakpogingen en zwakke batterij

Eenvoudige batterijvervanging (CR123A voorgeïnstalleerd)

Omvat montage-hardware voor eenvoudige installatie



Buitenafmeting (h x b x d): 12,7cm x 8,3cm x 5,9cm

Binnenafmeting (h x b x d): 9,4cm x 6,2cm x 2,5cm

ML 5441-EURD

---

your world safely locked //®

Versie v1.1.2

Info@dombrecht.eu www.dombrecht.eu  
Tel: 052/44 74 84 Fax: 052/44 90 52



**Dombrecht**  
DISTRIBUTION

Wij nodigen u uit om onze nieuwe WEBSHOP te bezoeken [www.dombrecht.eu](http://www.dombrecht.eu)

- Gebruik uw vertrouwde login van onze dealer area en krijg toegang tot uw persoonlijke account en dat 24/7
  - Raadpleeg uw order/offerte historie
  - Informeer u over de orderstatus van uw bestellingen
  - Voeg artikelen toe aan uw lijstje met Mijn favorieten
- Bewaar een ordertemplate voor uw steeds weerkerende bestellingen of om uw bestelling op een later tijdstip door te geven
  - Extra informatietools (brochures, video's,...) helpen u verder in uw artikelkeuze
  - Plaats snel en eenvoudig artikelen in uw winkelmandje
  - In uw winkelmandje kan u ook uw persoonlijke korting/prijs terugvinden

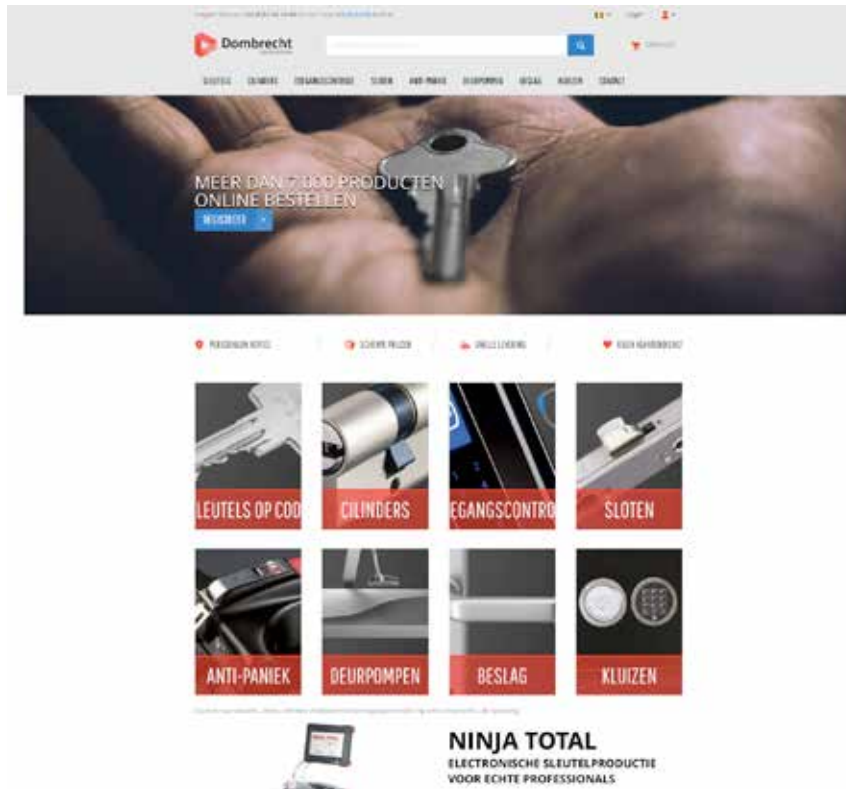

Wij doen steeds ons uiterste best om bestellingen zsm te verwerken en uit te sturen; sleutels op code in nabestelling vertrekken in principe de eerste werkdag volgend op de bestelling uit onze magazijnen overige bestellingen cilindermontage; 'kleine' orders +/- 5 werkdagen, 'grotere' orders +/- 10 werkdagen (bij nieuwe sleutelplannen is de datum van goedkeuring van het raster de start van de vooropgestelde levertermijn) overige bestellingen asap, webshop-orders worden prioritair behandeld

Na verzending uit onze magazijnen in principe maximaal 48u (2 werkdagen) levertermijn  
Franco levering vanaf € 250, netto ('klassieke' orders) of vanaf € 100, netto (webshop-orders)

**Franco Friday: alle orders die 's vrijdags in de webshop worden geplaatst zijn altijd franco**

Transportkosten: € 16 (standaard) of € 8 (bestellingen met maximaal een 10-tal sleutels of webshop-orders)

Meerprijzen levering op maat (coll'i's):

Gegarandeerde levering binnen 24 ipv 48u na verzending:

+ € 20 (tot max 1kg)

+ € 30 (tot max 10kg)

+ € 45 (tot max 30kg)

Gegarandeerde levering daags na verzending vóór 12.00u:

+ € 11

Gegarandeerde levering daags na verzending vóór 10.00u:

+ € 35

Gegarandeerde levering daags na verzending vóór 09.00u (of levering op zaterdag vóór 12.00u):

+ € 50

300

your world safely locked //®

#### Artikel 1: Aanvaarding van onderhavige voorwaarden

Enkel onderhavige verkoopvoorwaarden zijn van toepassing op de overeenkomsten, afgesloten door de NV Dombrecht Distribution, behalve wanneer hieraan uitdrukkelijk en schriftelijk enige afwijking wordt toegestaan. Bijgevolg stemt de klant automatisch in met onderhavige voorwaarden en verzaakt hij hierdoor aan zijn eigen bijzondere of algemene voorwaarden. Eventuele vroegere afwijkingen worden niet verlengd tenzij mits uitdrukkelijk schriftelijk akkoord van de NV Dombrecht Distribution.

#### Artikel 2: Offerte en Bestelling

Onze offertes zijn slechts geldig gedurende 30 dagen. De klant is onherroepelijk verbonden door de ondertekening van een bestelbon. De NV Dombrecht Distribution is slechts geldig verbonden wanneer de bestelling schriftelijk door de maatschappelijke zetel wordt bevestigd.

Aanduidingen en beschrijvingen van onze artikelen (technische kenmerken, presentatie, toebehoren) in onze catalogussen, prospectussen, offertes, documentatie of tarieven alsook leveringstermijn zijn zo nauwkeurig mogelijk, maar worden enkel medegedeeld ten titel van inlichting en zonder enige verbintenissen.

De NV Dombrecht Distribution behoudt zich het recht voor deze te allen tijde te wijzigen.

Het annuleren van een bestelling door de klant geeft aanleiding tot een schadevergoeding van 15% van het orderbedrag, omwille van administratiekosten en winstderving. Indien de bestelling niet-voorraadhoudende goederen omvat of indien er reeds productie- plannen werden gemaakt bedraagt de schadevergoeding 30%. Ingeval de productie reeds een aan- vang nam, zal de schadevergoeding verhoogd worden met het reeds uitgevoerd werk.

#### Artikel 3: Betalingsvoorwaarden

Onze facturen zijn contant betaalbaar op de hoofdzetel van Dombrecht Distribution.

Betaling dient te gebeuren zonder korting of verrekening.

Dombrecht Distribution is te allen tijde gerechtigd een voorschot te eisen op te leveren artikelen of te verrichten werkzaamheden. Tevens is Dombrecht Distribution gemachtigd andere zekerheid te verlangen voor de nakoming van de verplichtingen van de klant.

Door de klant gedane betalingen strekken steeds in mindering in de eerste plaats op alle verschuldigde rente en kosten en in de tweede plaats op de facturen die het langst opeisbaar zijn, zelfs al vermeldt de klant dat de betaling betrekking heeft op een latere factuur.

Elke factuur die niet betaald is op de vervaldag brengt van rechtswege en zonder voorafgaandelijke ingebrekestelling een nalatigheidsintrest op van 12% per jaar ingaand vanaf de vervaldag. Bij gebrek aan vermelding van een bijzondere vervaldag wordt deze geacht samen te vallen met de factuurdatum.

Onze prijzen verstaan zich BTW niet inbegrepen.

Bij gebreke of gedeeltelijke niet-betaling op de vervaldag wordt het schuldsaldo verhoogd met 15% en met een minimum van 50 EUR ten titel van forfaitair schadebeding. In geval van niet-betaling van een enkele factuur op de vastgestelde vervaldatum, liquidatie, faillissement, gerechtelijke organisatie of (gedeeltelijke) beslaglegging op het vermogen van de klant:

- Zullen de eventueel toegekende betalingstermijnen voor alle facturen vervallen en zullen alle op dat ogenblik verschuldigde bedragen onmiddellijk opeisbaar zijn;

- Zullen de toegestane betalingskortingen vermeld op de facturen eveneens vervallen;

- De NV Dombrecht Distribution behoudt zich het recht voor alleen nog te leveren tegen terugbetaling of in geval van borgstelling.

De klacht van de klant verleent hem niet het recht de betaling geheel of gedeeltelijk op te schorten. Artikel 4: Klachten

Op straffe van verval van recht moet elke klacht of protest bij aangetekend schrijven en binnen de 5 werkdagen na ontvangst der goederen geschieden. Indien de klant verzuimt levering te nemen, begint de termijn van 5 werkdagen te lopen bij ontvangst van de verzendnota of van elk gelijkwaardig document. Bij ontstentenis hiervan, vanaf ontvangst van de factuur. Indien binnen deze termijn van 5 werkdagen geen klacht werd ontvangen, heeft dit voor gevolg dat de klant de geleverde artikelen volledig in zijn geheel aanvaard heeft. Dit geldt uitdrukkelijk zowel voor de verborgen als voor de zichtbare gebreken.

Geen enkele terugzending mag zonder de schriftelijke instemming van de NV Dombrecht Distribution gebeuren. Deze instemming betekent geen erkenning.

#### Artikel 5: Garantie

De geleverde goederen zijn gewaarborgd tegen elke constructiefout gedurende een periode van 1 jaar. Deze termijn gaat in op de dag van de ontvangst van het product door de klant.

De vervanging of herstelling van een onderdeel gedurende de periode van de waarborg kan deze niet verlengen. Onze verantwoordelijkheid beperkt zich tot onze klanten-installateurs. Eventuele bezoeken bij particulieren hebben enkel een technisch hulpverlenend karakter en sluiten iedere verantwoordelijkheid uit. Het nakomen van onze waarborgverplichting is afhankelijk van de verplichting van de klant onze facturen binnen de 8 dagen na factuurdatum te voldoen.

#### Artikel 6: Levering

Alle bedingen betreffende de leveringstermijn worden beschouwd als gedaan ter indicatieve titel. Het niet tijdig leveren doet geen enkel recht op schadevergoeding ontstaan in hoofde van de klant. De goederen worden steeds vervoerd op risico van de bestemming. Deze heeft derhalve de plicht elk noodzakelijk voorbehoud te maken bij de vervoerders zo dit nodig blijkt.

In geval van weigering van afname door de klant of indien de klant nalatig is met het verstrekken van informatie of instructies, noodzakelijk voor de levering, zullen de zaken worden opgeslagen voor risico van de bestemming. Door de bestemming zijn de transport- en/of de opslagkosten verschuldigd, onverminderd het recht van Dombrecht Distribution op volledige schadevergoeding. Het is Dombrecht Distribution toegestaan verkochte artikelen in gedeelten te leveren. Desgevallend is Dombrecht Distribution gemachtigd elk gedeelte afzonderlijk te factureren.

Voor verzending worden de daadwerkelijke verzend- en administratiekosten met een minimum van €16 in rekening gebracht, voor zowel binnen België als naar het buitenland.

#### Artikel 7: Eigendomsvoorbehoud

De klant wordt pas eigenaar van de verkochte goederen nadat de verschuldigde sommen volledig betaald zijn. De risico's die de goederen kunnen lopen, vallen evenwel ten laste van de klant zodra deze ter zijner beschikking worden gesteld.

Indien de klant zijn verplichtingen jegens Dombrecht Distribution niet nakomt of er gegronde vrees bestaat dat deze zulks niet zal doen, is Dombrecht Distribution gerechtigd de geleverde goederen, waarop het eigendomsvoorbehoud rust, bij de klant of bij derden, die de goederen voor de klant houdt, weg te (doen) halen, met inbegrip van daartoe eventueel benodigde demontage. De klant is verplicht hiertoe alle medewerking te verlenen op straffe van een vergoeding van 10% van de verkoopwaarde, excl. BTW, van de betreffende goederen per dag of gedeelte daarvan dat de klant hierin nalatig blijft, onverminderd het recht van Dombrecht Distribution op volledige schadevergoeding.

#### Artikel 8: Aansprakelijkheid

De verantwoordelijkheid van de NV Dombrecht Distribution is beperkt tot de teruggave van de prijs voor het niet-conform gedeelte van de opdracht en kan geen aanleiding geven tot schadevergoeding. In geval van overmacht vervallen de verbintenissen in hoofde van de NV Dombrecht Distribution ten opzichte van de klant. Behoudens uitdrukkelijk akkoord van de NV Dombrecht Distribution zal een geval van overmacht geen annulering meebrengen van de bestelling maar eventueel slechts een opschorting van de levering.

Worden beschouwd als gevallen van overmacht:

- Volledige of gedeeltelijke stakingen bij onze onderneming of onze leveranciers;

- Elke omstandigheid die het bekomen van goederen moeilijk maakt zoals embargo's, overheidsmaatregelen, burgeroorlogen en opstanden, lock-outs, rellen, machinebreuk, transportmoeilijkheden, epidemieën, brand, ernstige ongevallen, laattijdige ontvangst van al of niet beschadigde goederen en, in het algemeen, alle gebeurtenissen van die aard dat zij de bevoorrading of de normale verzending van onze producten belemmeren.

#### Artikel 9: Toepasselijk recht – bevoegdheid

Alleen de Belgische wet is van toepassing op alle geschillen van welke aard ook die rechtstreeks of onrechtstreeks zouden kunnen voortspruiten uit hoofde van welke onze overeenkomsten ook. Alleen de rechtbanken van het gerechtelijk arrondissement Brussel of het kanton Asse zijn bevoegd. De NV Dombrecht Distribution kan hieraan vrijwilling verzaken.

Van toepassing op alle producten in deze catalogo:  
Afwijkingen van maten, gewichten, kleuren en prijzen behouden wij ons wij ons nadrukkelijk voor. Graag geven wij prijsbestek voor al uw maatwerk en/of speciale uitvoeringen.  
Prijzen Exclusief 21%BTV

your world safely locked //®

Versie v1.1.2

Info@dombrecht.eu www.dombrecht.eu  
Tel: 052/44 74 84 Fax: 052/44 90 52



**Dombrecht**  
DISTRIBUTION





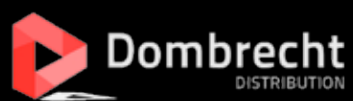

[www.dombrecht.eu](http://www.dombrecht.eu)

[Info@dombrecht.eu](mailto:Info@dombrecht.eu)

Tel: 052/44 74 84 Fax: 052/44 90 52